



POLICY ROUNDTABLES

Competition, State Aids and Subsidies 2010

Introduction

The OECD Global Forum on Competition debated Competition, State aids and Subsidies in February 2010. This document includes an executive summary of the debate and the meeting's documentation: an analytical note by Mr. David Spector for the OECD Secretariat, written submissions from Argentina, Croatia, Egypt, the European Union, the Former Yugoslav Republic of Macedonia, India, Jordan, Lithuania, Mongolia, Morocco, Pakistan, Peru, Poland, Romania, the Russian Federation, Senegal, Spain, Chinese Taipei, Ukraine, the United States, BIAC as well as a Keynote Speech by the EU Competition Commissioner, contributions from several experts and an aide-memoire of the discussion.

Overview

State aids and subsidies represent a significant amount of public funds and governments grant subsidies in a multiplicity of ways. However, a large heterogeneity exists among systems of control, both at the supranational and national levels. The actual impact of state aids and subsidies is difficult to assess. On the one hand, they may cause distortions and inefficiencies. On the other hand they are frequently rationalised as an instrument to tackle market failures and to produce positive externalities.

To improve the assessment of state aids and subsidies measures, governments should adopt general screening *ex ante* and limiting criteria. *Ex post* assessment mechanisms should also be put in place in order to limit their negative impact. Furthermore, competition authorities should hold state-owned enterprises and government agencies to the same standards as private companies regarding the control of anticompetitive behaviour. Finally, advocacy by competition authorities to other parts of the Government should also contribute to keeping the granting of state aids in check.

Related Topics

Competition Policy, Industrial Policy and National Champions (2009)
Competition and Financial Markets (2009)
State-Owned Enterprises and the Principle of Competitive Neutrality (2009)
Concessions (2006)

Unclassified

DAF/COMP/GF(2010)5



Organisation de Coopération et de Développement Économiques
Organisation for Economic Co-operation and Development

19-May-2011

English, French

**DIRECTORATE FOR FINANCIAL AND ENTERPRISE AFFAIRS
COMPETITION COMMITTEE**

**DAF/COMP/GF(2010)5
Unclassified**

Global Forum on Competition

ROUNDTABLE ON COMPETITION, STATE AIDS AND SUBSIDIES

JT03302066

Document complet disponible sur OLIS dans son format d'origine
Complete document available on OLIS in its original format

English, French

FOREWORD

This document comprises proceedings in the original languages of a Roundtable on Competition, State Aids and Subsidies, held by the Global Forum on Competition in February 2010.

It is published under the responsibility of the Secretary General of the OECD to bring information on this topic to the attention of a wider audience.

This compilation is one of a series of publications entitled "Competition Policy Roundtables".

PRÉFACE

Ce document rassemble la documentation dans la langue d'origine dans laquelle elle a été soumise, relative à une table ronde sur Concurrence, aides publiques et subventions qui s'est tenue en février 2010 dans le cadre du Forum mondial sur la concurrence.

Il est publié sous la responsabilité du Secrétaire général de l'OCDE, afin de porter à la connaissance d'un large public les éléments d'information qui ont été réunis à cette occasion.

Cette compilation fait partie de la série intitulée "Les tables rondes sur la politique de la concurrence".

Visit our Internet Site -- Consultez notre site Internet

<http://www.oecd.org/competition>

OTHER TITLES**SERIES ROUNDTABLES ON COMPETITION POLICY**

1.	Competition Policy and Environment	OCDE/GD(96)22
2.	Failing Firm Defence	OCDE/GD(96)23
3.	Competition Policy and Film Distribution	OCDE/GD(96)60
4.	Competition Policy and Efficiency Claims in Horizontal Agreements	OCDE/GD(96)65
5.	The Essential Facilities Concept	OCDE/GD(96)113
6.	Competition in Telecommunications	OCDE/GD(96)114
7.	The Reform of International Satellite Organisations	OCDE/GD(96)123
8.	Abuse of Dominance and Monopolisation	OCDE/GD(96)131
9.	Application of Competition Policy to High Tech Markets	OCDE/GD(97)44
10.	General Cartel Bans: Criteria for Exemption for Small and Medium-sized Enterprises	OCDE/GD(97)53
11.	Competition Issues related to Sports	OCDE/GD(97)128
12.	Application of Competition Policy to the Electricity Sector	OCDE/GD(97)132
13.	Judicial Enforcement of Competition Law	OCDE/GD(97)200
14.	Resale Price Maintenance	OCDE/GD(97)229
15.	Railways: Structure, Regulation and Competition Policy	DAFFE/CLP(98)1
16.	Competition Policy and International Airport Services	DAFFE/CLP(98)3
17.	Enhancing the Role of Competition in the Regulation of Banks	DAFFE/CLP(98)16
18.	Competition Policy and Intellectual Property Rights	DAFFE/CLP(98)18
19.	Competition and Related Regulation Issues in the Insurance Industry	DAFFE/CLP(98)20
20.	Competition Policy and Procurement Markets	DAFFE/CLP(99)3
21.	Regulation and Competition Issues in Broadcasting in the light of Convergence	DAFFE/CLP(99)1
22.	Relationship between Regulators and Competition Authorities	DAFFE/CLP(99)8
23.	Buying Power of Multiproduct Retailers	DAFFE/CLP(99)21
24.	Promoting Competition in Postal Services	DAFFE/CLP(99)22
25.	Oligopoly	DAFFE/CLP(99)25
26.	Airline Mergers and Alliances	DAFFE/CLP(2000)1
27.	Competition in Professional Services	DAFFE/CLP(2000)2
28.	Competition in Local Services	DAFFE/CLP(2000)13
29.	Mergers in Financial Services	DAFFE/CLP(2000)17
30.	Promoting Competition in the Natural Gas Industry	DAFFE/CLP(2000)18
31.	Competition Issues in Electronic Commerce	DAFFE/CLP(2000)32
32.	Competition and Regulation Issues in the Pharmaceutical Industry	DAFFE/CLP(2000)29

33.	Competition Issues in Joint Ventures	DAFFE/CLP(2000)33
34.	Competition Issues in Road Transport	DAFFE/CLP(2001)10
35.	Price Transparency	DAFFE/CLP(2001)22
36.	Competition Policy in Subsidies and State Aid	DAFFE/CLP(2001)24
37.	Portfolio Effects in Conglomerate Mergers	DAFFE/COMP(2002)5
38.	Competition and Regulation Issues in Telecommunications	DAFFE/COMP(2002)6
39.	Merger Review in Emerging High Innovation Markets	DAFFE/COMP(2002)20
40.	Loyalty and Fidelity Discounts and Rebates	DAFFE/COMP(2002)21
41.	Communication by Competition Authorities	DAFFE/COMP(2003)4
42.	Substantive Criteria used for the Assessment of Mergers	DAFFE/COMP(2003)5
43.	Competition Issues in the Electricity Sector	DAFFE/COMP(2003)14
44.	Media Mergers	DAFFE/COMP(2003)16
45.	Non Commercial Services Obligations and Liberalisation	DAFFE/COMP(2004)19
46.	Competition and Regulation in the Water Sector	DAFFE/COMP(2004)20
47.	Regulating Market Activities by Public Sector	DAF/COMP(2004)36
48.	Merger Remedies	DAF/COMP(2004)21
49.	Cartels: Sanctions against Individuals	DAF/COMP(2004)39
50.	Intellectual Property Rights	DAF/COMP(2004)24
51.	Predatory Foreclosure	DAF/COMP(2005)14
52.	Competition and Regulation in Agriculture: Monopsony Buying and Joint Selling	DAF/COMP(2005)44
53.	Enhancing Beneficial Competition in the Health Professions	DAF/COMP(2005)45
54.	Evaluation of the Actions and Resources of Competition Authorities	DAF/COMP(2005)30
55.	Structural Reform in the Rail Industry	DAF/COMP(2005)46
56.	Competition on the Merits	DAF/COMP(2005)27
57.	Resale Below Cost Laws and Regulations	DAF/COMP(2005)43
58.	Barriers to Entry	DAF/COMP(2005)42
59.	Prosecuting Cartels without Direct Evidence of Agreement	DAF/COMP/GF(2006)7
60.	The Impact of Substitute Services on Regulation	DAF/COMP(2006)18
61.	Competition in the Provision of Hospital Services	DAF/COMP(2006)20
62.	Access to key Transport Facilities	DAF/COMP(2006)29
63.	Environmental Regulation and Competition	DAF/COMP(2006)30
64.	Concessions	DAF/COMP/GF(2006)6
65.	Remedies and Sanctions	DAF/COMP(2006)19
66.	Competition in Bidding Markets	DAF/COMP(2006)31
67.	Competition and Efficient Usage of Payment cards	DAF/COMP(2006)32
68.	Vertical mergers	DAF/COMP(2007)21
69.	Competition and Regulation in Retail Banking	DAF/COMP(2006)33
70.	Improving Competition in Real Estate Transactions	DAF/COMP(2007)36
71.	Public Procurement – The Role of Competition Authorities in Promoting Competition	DAF/COMP(2007)34

72.	Competition, Patents and Innovation	DAF/COMP(2007)40
73.	Private Remedies	DAF/COMP(2006)34
74.	Energy Security and Competition Policy	DAF/COMP(2007)35
75.	Plea Bargaining Settlement of Cartel Cases	DAF/COMP(2007)38
76.	Competitive Restrictions in Legal Professions	DAF/COMP(2007)39
77.	Dynamic Efficiencies in Merger Analysis	DAF/COMP(2007)41
78.	Guidance to Business on Monopolisation and Abuse of Dominance	DAF/COMP(2007)43
79.	The Interface between Competition and Consumer Policies	DAF/COMP/GF(2008)10
80.	Facilitating Practices in Oligopolies	DAF/COMP(2008)24
81.	Taxi Services Regulation and Competition	DAF/COMP(2007)42
82.	Techniques and Evidentiary Issues in Proving Dominance/ Monopoly Power	DAF/COMP(2006)35
83.	Managing Complex Merger Cases	DAF/COMP(2007)44
84.	Potential Pro-Competitive and Anti-Competitive Aspects of Trade/Business Associations	DAF/COMP(2007)45
85.	Market Studies	DAF/COMP(2008)34
86.	Land Use Restrictions as Barriers to Entry	DAF/COMP(2008)25
87.	Construction Industry	DAF/COMP(2008)36
88.	Antitrust Issues Involving Minority Shareholding and Interlocking Directorates	DAF/COMP(2008)30
89.	Bundled and Loyalty Discounts and Rebates	DAF/COMP(2008)29
90.	Techniques for Presenting Complex Economic Theories to Judges	DAF/COMP(2008)31
91.	Competition Policy for Vertical Relations in Gasoline Retailing	DAF/COMP(2008)35
92.	Competition and Financial Markets	DAF/COMP(2009)11
93.	Refusals to Deal	DAF/COMP(2007)46
94.	Resale Price Maintenance	DAF/COMP(2008)37
95.	Experience with Direct Settlements in Cartel Cases	DAF/COMP(2008)32
96.	Competition Policy, Industrial Policy and National Champions	DAF/COMP/GF(2009)9
97.	Two-Sided Markets	DAF/COMP(2009)20
98.	Monopsony and Buyer Power	DAF/COMP(2008)38
99.	Competition and Regulation in Auditing and Related Professions	DAF/COMP(2009)19
100.	Roundtable on competition policy and the informal economy	DAF/COMP/GF(2009)10
101.	Competition, Patents and Innovation II	DAF/COMP(2009)22
102.	The Standard for Merger Review, with a Particular Emphasis on Country Experience with the change of Merger Review Standard from the Dominance Test to the SLC/SIEC Test	DAF/COMP(2009)21
103.	Failing Firm Defence	DAF/COMP(2009)38
104.	Competition, Concentration And Stability in the Banking Sector	DAF/COMP(2010)9
105.	Margin Squeeze	DAF/COMP(2009)36
106.	State-Owned Enterprises and the Principle of Competitive Neutrality	DAF/COMP(2009)37
107.	Generic Pharmaceuticals	DAF/COMP(2009)39

DAF/COMP/GF(2010)5

108.	Collusion and Corruption in Public Procurement	DAF/COMP/GF(2010)6
109.	Electricity: Renewables and Smart Grids	DAF/COMP(2010)10
110.	Exit Strategies	DAF/COMP(2010)32
111.	Standard Setting	DAF/COMP(2010)33

TABLE OF CONTENTS

EXECUTIVE SUMMARY	9
SYNTHÈSE.....	13
BACKGROUND NOTE	17
NOTE DE RÉFÉRENCE	49
 CONTRIBUTIONS	
Argentina.....	85
Croatia	91
Egypt	99
European Union	105
Former Yugoslav Republic of Macedonia	115
India.....	119
Jordan	125
Lithuania.....	129
Mongolia	135
Morocco	139
Maroc	145
Pakistan	153
Peru	159
Poland.....	173
Romania	177
Russian Federation	185
Senegal	187
Sénégal	193
Spain.....	199
Chinese Taipei.....	207
Ukraine	213
United States (Federal Trade Commission).....	217
BIAC	223
 OTHERS	
Mr. Joaquín Almunia, Commissioner for Competition (EU).....	229
Ms. Thitapha Wattanapruttipaisan (ASEAN).....	233
Mr. Amadou Dieng (WAEMU)	237
M. Amadou Dieng (UEMOA).....	245
Presentation by Mr. Amadou Dieng (WAEMU).....	253
Presentation by Mr. Michael Thöne (FIFO Institute, Germany)	261
SUMMARY OF DISCUSSION.....	265
COMPTE RENDU DE LA DISCUSSION	275

EXECUTIVE SUMMARY

By the Secretariat

From the background paper, country contributions and the discussion at the roundtable held at the 2010 Global Forum on Competition, the following key points emerge on *Competition policy, State Aids and Subsidies*.

- (1) *State aids and subsidies represent a significant amount of public funds and governments grant subsidies in a multiplicity of ways.*

Despite the downward trend in the amount of state aids and subsidies granted by governments, they still account for a significant share of the world economy. Even in the European Union, where control is the strictest, state aids represent about 1% of EU GDP excluding crisis-related measures.

Furthermore, globalisation intensifies competition between countries, especially for foreign investment. It could make the problem of subsidy races more acute. It could also in some cases result in a protectionist backlash, possibly inducing a growing use of subsidies. It thus appears essential to develop tools in order to help governments and competition authorities differentiate between efficient and inefficient state aid measures and limit the wasteful granting of subsidies.

Governments granting state aids may use a wide variety of different instruments, including direct subsidies, tax breaks or loan guarantees. They can subsidise inputs or buy a firm's products at an above-market price. Also, State-owned enterprises ("SOE") are often important recipients of state aids and in many countries, the largest share of subsidies is devoted to preserving loss-making SOEs.

- (2) *There exists a large heterogeneity among systems of control of state aids and subsidies, both at the supranational and national levels.*

A government measure is usually considered an aid if it involves a certain degree of selectivity, i.e. if it is directed to a specific sector or a specific enterprise, and thus susceptible of significantly distorting competition. However, the definition of an aid may vary considerably across countries. For example, a measure could be considered as constituting an aid according to EU definitions, but not according to the WTO, and vice-versa.

Furthermore, control over state aids takes quite different forms from a jurisdiction to another. The most striking example of the variety of supranational state aid control rules is the difference between the WTO and the EU systems. WTO rules do not provide for any *ex ante* control. The control is *ex post* and allows a Member State to challenge the subsidy granted by another Member State before the WTO settlement body. On the contrary, in the European system, control takes place both *ex ante* and *ex post*. A country planning to grant an aid must notify the measure to the Commission and wait for a clearance decision before implementing the aid. *Ex post*, the Commission must keep existing aids under review and has the power to require the modification of the previously authorised scheme if market circumstances have evolved.

Other regional trade blocs, such as the West African Economic and Monetary Union (“WAEMU”) also have specific supranational state aid control rules. The WAEMU state aid rules rely on control both *ex ante* and *ex post* but the WAEMU Commission acknowledges that the rules are not enforced effectively yet. One of the reasons is that the WEAMU Commission has to overcome the absence of a supranational culture that would be needed in order to ensure that state aid control rules prevail over national regulations.

Commercial agreements and regional integration often foster the development of national state aid rules systems. For instance, the Free Trade Area Agreement signed between Ukraine and the European Union obligates Ukraine to prohibit state aids that distort competition. Ukraine has been benefiting from EU technical support in order to implement an efficient state aid monitoring system. Likewise, Croatia, which is in the process of joining the EU, is currently improving its state aid control system in order to make it comply with the EU rules.

Finally, many countries, where no genuine state aid system is implemented, have laws ensuring a “competitive neutrality principle”. This is the case of Brazil and Australia among other countries. This principle seeks to ensure that SOEs compete on fair grounds against private entities. However, the competitive neutrality principle does not address cases where governments provide specific private entities with a competitive advantage.

(3) *State aids measures may cause distortions and inefficiencies*

Subsidy races come from the existence of negative externalities between jurisdictions: the granting of an aid may be a sound policy from the narrow viewpoint of a local or national authority, but when such aid merely shifts economic activity from a region to another, it is globally wasteful. Subsidy races thrive in Federal States where cross-state competition leads local states or regions to engage in costly races to shift activities from neighbouring states to themselves without creating new activities. Subsidy races are somewhat kept under control by supranational systems such as the European Union, but even there, where state aid control is considered the most stringent, they are not entirely kept in check and they often yield inefficient allocation of resources among regions.

Allocative and technical inefficiencies are the first category of inefficiencies caused by state aid measures. Both types of inefficiencies result from the fact that subsidies interfere with market signals, usually creating various kinds of distortions and decreasing productive and allocative efficiency. Where state aids amount to a general subsidisation of inputs, the inefficiency results from the discrepancy between the prices perceived by economic agents and the underlying costs. The case of energy subsidies provides a striking example of such distortions. Subsidising fossil fuels tends to discourage conservation efforts and to induce economic agents to behave without taking into account the true marginal production costs of fossil fuels. Furthermore, this is environmentally costly since it counters efforts to limit emissions.

The provision of subsidies to specific firms may also yield capital misallocation. The source of the inefficiency is that if such subsidies are granted to inefficient firms, they shift production towards less efficient units, thereby increasing total production costs and/or lowering the quantity of output produced. Such productive inefficiencies are particularly likely to arise in countries where a large part of the subsidies are granted in order to keep loss-making companies (often SOEs) afloat rather than with the objective to correct market failures. Likewise, sectoral aid may lead to overproduction in the subsidised sector and underproduction in others.

A last consequence of the large amount of state aids and subsidies directed to inefficient firms is the distortions of firms’ incentives resulting from the “soft budget constraint”. In this case, the source of the inefficiency is not the subsidy itself, but rather the expectation that failing firms

could be bailed-out and subsidised in the future. This lessens incentives to innovate, raise quality or cut costs, both for efficient and inefficient firms. In particular, efficient firms' incentives are likely to be dampened if they expect that their resulting competitive advantage will be offset by the granting of an aid to their rivals. As regards the inefficient firm, two effects can arise from the expectation that it will be bailed-out in case of difficulties. It may be encouraged to engage in overly risky investments, or it may be less prompt to address the source of its inefficiencies.

- (4) *State aids policies are frequently rationalised as an instrument to tackle market failures and to produce positive externalities.*

Many state aid measures aim at palliating credit and financial market imperfections. In the presence of credit market imperfections, firms that could engage in productive activities may be prevented from doing so because of insufficient access to credit due to asymmetrical information between lenders and borrowers. As standard economic theory has shown, the private supply of credit may be suboptimal in the presence of asymmetric information, which may in principle justify the subsidisation of credit even if governments are no better informed than private lenders. In developing countries, subsidised lending seems to often have a positive impact on economic activity and on the ability of small firms to invest.

Another common justification for state aids is that they can serve as a useful tool to help governments foster research, development and innovation. R&D&I is considered to give rise to externalities: new knowledge generated by R&D&I may be beneficial to society as a whole thanks to knowledge spillovers. However, some firms may be deterred from investing in R&D&I because their private benefits may be limited whereas social benefits could be important. Aid to R&D&I is often meant to remedy the suboptimal level of investment caused by the presence of externalities and informational asymmetries.

However, one should bear in mind that this kind of aids may give rise to inefficiencies. More generally, as is advocated by the European Commission, governments should balance the positive expected impact of a measure and the expected competition distortions when designing a state aid measure.

- (5) *Steps that could be taken to improve the assessment of state aid and subsidies measures*

The greatest difficulty that must be dealt with, when balancing the positive and negative impact of a state aid measure, is that the analysis is mainly a prospective one. This difficulty is greatest in the case of aid aimed at fostering innovation, since the result of innovation is uncertain by nature.

To remedy these difficulties, avoid putting into force a too costly monitoring system, and meet the goal of less and better targeted state aid, governments should adopt general screening and limiting criteria. These criteria could be the following: (i) each subsidy should be subject to an economic analysis precisely identifying which market failure needs correction, and the extent to which the aid measure is likely to remedy it; (ii) a subsidy should be granted only if it can be proved that no more transparent, less discriminatory measure can meet the same goal; (iii) rules should be designed in a way limiting the magnitude and duration of aids; and (iv) there should be a rule implying that when large firms receive subsidies, they must provide something in return.

Ex post assessment mechanisms should also be put in place in order to limit the negative impact of state aids and subsidies. Furthermore, competition authorities should hold SOEs and government agencies to the same standards as private companies regarding the control of anticompetitive behaviour. Finally, advocacy by competition authorities should also contribute to keeping the granting of state aids in check.

SYNTHÈSE

Par le Secrétariat

Au vu du document de référence, des contributions des pays, et des débats lors de la table-ronde sur la concurrence, les aides publiques et les subventions qui a eu lieu à l'occasion du Forum mondial sur la concurrence en 2010, les points essentiels qui se dégagent sont les suivants :

- (1) *Les aides publiques et les subventions représentent une part importante des ressources publiques et les gouvernements accordent des subventions sous diverses formes.*

Malgré la diminution tendancielle du montant des aides publiques et des subventions octroyées par les gouvernements, ces concours représentent encore une part importante de l'économie mondiale. Même au sein de l'Union européenne, où le contrôle est le plus strict, les aides publiques représentent environ 1 % du PIB hors mesures liées à la crise.

Par ailleurs, la mondialisation intensifie la concurrence entre les pays, surtout pour l'investissement étranger. Cela pourrait exacerber le problème de la course aux subventions ; cela pourrait aussi, dans certains cas, provoquer une recrudescence du protectionnisme, avec le risque d'un recours croissant aux subventions. Il paraît donc essentiel de mettre au point des outils afin d'aider les responsables gouvernementaux et les autorités de la concurrence à distinguer entre les mesures d'aide publique qui sont efficaces et celles qui ne le sont pas et à limiter le gaspillage dans l'octroi de subventions.

Les gouvernements qui offrent des aides publiques peuvent le faire au moyen d'instruments divers tels que subventions directes, allègements fiscaux ou garanties de prêt. Ils peuvent subventionner les moyens de production ou acheter les produits d'une entreprise à un prix supérieur à celui du marché. Les entreprises publiques, elles aussi, bénéficient souvent d'aides importantes de l'État et, dans bien des pays, la majeure partie des subventions est consacrée au maintien en activité d'entreprises publiques non rentables.

- (2) *Les systèmes de contrôle des aides publiques et des subventions sont très hétérogènes, tant au niveau supranational qu'au niveau national.*

Une mesure gouvernementale est généralement considérée comme une aide si elle présente un certain degré de sélectivité, c'est-à-dire si elle vise un secteur ou une entreprise en particulier et est donc susceptible de fausser notablement la concurrence. Cependant, la définition d'une aide n'est pas la même dans tous les pays. Une mesure pourrait, par exemple, être considérée comme constituant une aide selon les définitions de l'UE mais non selon l'OMC, et vice-versa.

De plus, le contrôle des aides publiques revêt des formes très différentes selon les pays. L'exemple le plus frappant de la diversité des règles supranationales de contrôle des aides publiques est la différence entre les systèmes de l'OMC et de l'UE. Les règles de l'OMC ne prévoient aucun contrôle *ex ante*. Le contrôle s'exerce *ex post et* autorise un État membre à contester la subvention accordée par un autre membre auprès de l'organe de règlement des différends de l'OMC. Dans le système européen, au contraire, le contrôle s'exerce à la fois *ex*

ante et *ex post*. Un pays qui prévoit d'octroyer une aide doit en informer la Commission et attendre que l'autorisation lui soit donnée de mettre en œuvre cette mesure. *Ex post*, la Commission doit continuer de contrôler les aides existantes et a le pouvoir d'exiger la modification d'un dispositif qu'elle avait autorisé auparavant si la situation du marché a évolué.

D'autres blocs commerciaux régionaux, tels que l'Union économique et monétaire ouest africaine (UEMOA), ont aussi des règles supranationales spécifiques de contrôle des aides publiques. Celles de l'UEMOA prévoient un contrôle à la fois *ex ante* et *ex post* mais la Commission de l'UEMOA reconnaît que ces règles ne sont pas encore appliquées dans les faits. Une des raisons à cela est que la Commission se heurte à l'absence d'une culture supranationale qui serait nécessaire pour faire en sorte que les règles de contrôle des aides publiques prévalent sur les réglementations nationales.

Les accords commerciaux et l'intégration régionale favorisent souvent la mise en place de systèmes nationaux de contrôle des aides publiques. L'Accord de libre-échange signé entre l'Ukraine et l'Union européenne, par exemple, interdit les aides publiques qui faussent la concurrence. L'Ukraine bénéficie d'un soutien technique de l'UE pour la mise en œuvre d'un système efficace de suivi des aides publiques. De même, la Croatie, qui est en voie d'adhésion à l'UE, améliore actuellement son système de contrôle afin de se conformer aux règles de l'UE.

Enfin, de nombreux pays où il n'existe pas de véritable système d'aides publiques ont des lois qui assurent un « principe de neutralité concurrentielle ». C'est le cas, notamment, du Brésil et de l'Australie. Ce principe veut que les entreprises publiques concurrencent de façon loyale les entités privées. Toutefois, le principe de neutralité concurrentielle n'intervient pas dans les cas où les gouvernements accordent un avantage concurrentiel à certaines entreprises privées.

(3) *Les mesures d'aides publiques peuvent causer des distorsions et inefficiences*

La course aux subventions est due à l'existence d'externalités négatives entre les pays : l'octroi d'une aide peut être une mesure saine du point de vue étroit d'une autorité locale ou nationale, mais lorsque cette aide revient simplement à déplacer l'activité économique d'une région à une autre, elle n'apporte rien au plan mondial. La course aux subventions est particulièrement développée dans les pays à structure fédérale où la concurrence entre États conduit ces derniers ou les régions à se lancer dans une course onéreuse pour attirer des activités situées dans des États voisins sans en créer de nouvelles. La course aux subventions est limitée, dans une certaine mesure, par des systèmes supranationaux tels que l'Union européenne mais, même là, où le contrôle des aides publiques est considéré comme étant le plus rigoureux, il est impossible d'empêcher complètement ce phénomène, et il en résulte souvent une affectation inefficace des ressources entre les régions.

Les inefficiences allocatives et techniques sont la première catégorie d'inefficiences causées par les aides publiques. Les deux types d'inefficiences sont dus au fait que les subventions interfèrent avec les signaux du marché, ce qui crée habituellement divers types de distorsions et réduit l'efficacité productive et allocative. Lorsque les aides publiques reviennent à un subventionnement général des moyens de production, l'inefficacité résulte de l'écart entre les prix perçus par les agents économiques et les coûts sous-jacents. Le cas des subventions en faveur de l'énergie offre un exemple frappant de ce genre de distorsions. Subventionner les combustibles fossiles tend à décourager les efforts de protection de l'environnement et à amener les agents économiques à ne pas tenir compte des véritables coûts marginaux de production de ces formes d'énergie. De plus, cette mesure nuit à l'environnement car elle va à l'encontre des efforts de limitation des émissions.

L'octroi de subventions à des entreprises particulières peut aussi fausser l'affectation du capital. Dans ce cas, le problème vient du fait que si ces subventions sont offertes à des entreprises qui manquent d'efficacité, elles déplacent la production vers les unités moins efficaces, ce qui augmente les coûts de production totaux et/ou réduit le volume de la production. Ces inefficiences productives sont particulièrement susceptibles d'apparaître dans les pays où les subventions sont destinées principalement à maintenir à flot des entreprises (souvent publiques) non rentables et non à corriger des défaillances du marché. De même, une aide sectorielle peut conduire à une surproduction dans le secteur subventionné et à une sous-production dans les autres.

Une dernière conséquence de la masse d'aides publiques et de subventions qui va à des entreprises inefficaces est que cela fausse les incitations que représente pour les entreprises une « faible contrainte budgétaire ». Dans ce cas, la source de l'inefficacité n'est pas la subvention elle-même, mais plutôt le fait que les entreprises en difficulté pourraient compter sur un sauvetage ou un subventionnement dans l'avenir. Cela affaiblit les incitations à innover, à améliorer la qualité ou à réduire les coûts, tant pour les entreprises efficaces que pour les autres. En particulier, les incitations pour les entreprises efficaces auront sans doute moins d'effet si ces dernières s'attendent à ce que l'avantage comparatif qui leur est ainsi conféré soit compensé par l'octroi d'une aide à leurs concurrentes. En ce qui concerne les entreprises inefficaces, le fait de s'attendre à un sauvetage en cas de difficultés peut produire un double effet : cela peut les encourager à se lancer dans des investissements excessivement risqués, ou atténuer leur promptitude à s'attaquer à la source de leur inefficacité.

- (4) *Pour justifier les aides publiques, les gouvernements les présentent souvent comme un instrument permettant de corriger les défaillances du marché et de créer des externalités positives.*

Bon nombre d'aides publiques visent à pallier les imperfections des marchés du crédit et des capitaux. En présence d'imperfections du marché du crédit, les entreprises qui pourraient se lancer dans des activités productives peuvent en être empêchées en raison de difficultés d'accès au crédit dues à une asymétrie de l'information entre prêteurs et emprunteurs. Selon une théorie économique traditionnelle, l'offre de crédit privée peut être sous-optimale en cas d'asymétrie de l'information, ce qui peut en principe justifier le subventionnement du crédit, même si les pouvoirs publics ne sont pas mieux informés que les prêteurs privés. Dans les pays en développement, le subventionnement du crédit semble avoir souvent un effet positif sur l'activité économique et sur la capacité d'investissement des petites entreprises.

Une autre raison couramment invoquée pour justifier les aides publiques est qu'elles peuvent être utiles pour aider les gouvernements à favoriser la recherche, le développement et l'innovation. La R-D-I est considérée comme créant des externalités : les connaissances nouvelles issues de la R-D-I peuvent avoir des retombées favorables pour la société tout entière. Toutefois, certaines entreprises peuvent être dissuadées d'investir dans la R-D-I du fait que leurs avantages privés seraient limités alors que les avantages sociaux seraient importants. L'aide à la R-D-I est souvent censée remédier au niveau sous-optimal de l'investissement dû à la présence d'externalités et à l'asymétrie de l'information.

Il convient cependant de garder présent à l'esprit le fait que ce type d'aides peut être source d'inefficacités. D'une manière plus générale, comme le préconise la Commission européenne, les gouvernements devraient mettre en balance l'impact positif attendu d'une mesure et les distorsions prévisibles de la concurrence lorsqu'ils envisagent d'accorder une aide publique.

(5) *Les mesures qui pourraient être prises pour améliorer l'évaluation des aides publiques et des subventions*

La plus grande difficulté à surmonter, lorsqu'on met en balance les effets positifs et négatifs d'une mesure d'aide publique, est que l'analyse est de nature principalement prospective. Cette difficulté est encore accrue dans le cas d'une aide destinée à stimuler l'innovation, puisque le résultat de l'innovation est, par nature, incertain.

Afin de remédier à ces difficultés, d'éviter de mettre en œuvre un système de suivi trop onéreux et d'atteindre l'objectif de réduction du nombre et de meilleur ciblage des aides publiques, les gouvernements devraient adopter des critères généraux de contrôle et de limitation. Ces critères pourraient être les suivants : (i) chaque subvention devrait faire l'objet d'une analyse économique afin de déterminer précisément quelle défaillance de marché à besoin de correction, et l'utilité que la mesure d'aide peut avoir à cet égard ; (ii) une subvention ne devrait être accordée que s'il peut être démontré qu'aucune mesure plus transparente et moins discriminatoire ne permettrait d'atteindre le même objectif ; (iii) des règles devraient être créées afin de limiter l'ampleur et la durée des aides ; et (iv) il devrait exister une règle exigeant que, lorsque de grandes entreprises reçoivent des subventions, elles fassent des concessions en contrepartie.

Il faudrait aussi mettre en place des mécanismes d'évaluation *ex post* afin de limiter l'impact négatif des aides publiques et des subventions. Par ailleurs, les autorités de la concurrence devraient assujettir les entreprises et organismes publics aux mêmes normes que les entreprises privées en ce qui concerne le contrôle des comportements anticoncurrentiels. Enfin, une action de sensibilisation de la part des autorités de la concurrence devrait aussi contribuer à maintenir sous contrôle l'octroi d'aides publiques.

BACKGROUND NOTE ^{*}

By the Secretariat

1. Subsidies, state aids and state aid control: the current situation

Preliminary remark: As is explained below, many different types of government actions can be described as state aids or subsidies, and we do not stick to a single precise definition. In general, these two words are used interchangeably hereafter, except when referring to the European Union (where the standard expression is “state aids”) or to the World Trade Organisation (which refers to “subsidies” in the context of the agreement on “subsidies and countervailing measures”).

1.1 *The importance of government subsidies to companies*

Governments can subsidise companies in a multiplicity of ways. They can grant direct subsidies or tax breaks to specific firms, with or without any strings attached. They can subsidise inputs such as land, energy, water, bandwidth for telecommunication services, either because these inputs are under direct government control, or because they are marketed by state-owned enterprises. Governments can also guarantee the loans taken up by some companies, allowing the beneficiaries to borrow at a below-market rate. Government-owned banks, or banks that are under strong government influence for regulatory reasons, can also offer direct credit under preferential terms to targeted companies or sectors.

State-owned enterprises (hereafter, “SOE”) are often an important conduit for, or recipient of, state aids. In many countries, governments devote considerable amounts to the subsidisation of SOEs, and in particular, loss-making SOEs. Historically, some countries have devoted substantial proportions of their national wealth to such SOE related state aid. For instance, in Sri-Lanka in the 1980s and 1990s, more than 30% of the budget, i.e., more than 10% of GDP was allocated to the “maintenance of SOEs”.¹ In China, 95% of subsidies to SOEs between 1995 and 2005, were directed to loss-making SOEs.² Those countries have since embarked on significant reform and transformation processes, shifting towards improved governance and more market-oriented solutions. In many countries, governments also own utilities in order to provide selected companies with basic inputs, such as energy or water, at below-market prices.

Governments can also subsidise companies by purchasing from them at above-market prices, or, less directly, by forcing some other companies to purchase from them at above-market prices. In some cases, such overpricing is part of an overt policy aimed to meet some public policy goal. For instance, in many countries, utilities have an obligation to purchase renewable energy at regulated, above-market prices. In

^{*} This background note was prepared for the Secretariat by David Spector, Paris School of Economics and MAPP. The views expressed in this paper are the personal responsibility of the author, David Spector. They should neither be attributed to the OECD Secretariat nor to OECD member countries. The author welcomes comments and corrections of factual errors, which can be sent to him at the following email address: spector@pse.ens.fr.

¹ S. Kelegama, 1993, Privatization in Sri Lanka: The Experience during the Early Years of Implementation. Colombo: Sri Lanka Economic Association.

² China fiscal yearbook, China statistical yearbook.

many countries, the military purchases domestic armaments, at prices that are usually far above export prices, suggesting the existence of an implicit subsidy.

Ascertaining whether a given government measure constitutes aid is not a simple matter. For instance, in the European Union (hereafter, the “EU”), where strict control of state aids exists, a considerable part of the debate surrounding individual cases concerns whether the government measure at stake indeed constitutes aid. Also, as is explained below, the definition of an aid varies across jurisdictions; for instance, some measures are considered to constitute aid according to EU definitions, but not according to World Trade Organisation (hereafter, “WTO”) definitions; and vice-versa.

The recent financial crisis provides a striking illustration. With the quasi-closure of some segments of the credit markets, some fundamentally sound banks, whose assets were unambiguously worth more than their liabilities, were facing the threat of short-run bankruptcy because they were entangled in a liquidity crisis. Suddenly, such banks found themselves deprived of the possibility of using their long-term assets (e.g., a portfolio of very safe long-term loans) as collateral in order to borrow and meet their short-term financial obligations, because the flow of credit directed to these refinancing operations had suddenly dried up. Many governments provided liability guarantees to such banks (at a cost), in order to allow them to borrow on financial markets. Whether this constitutes aid, and, if so, what the amount of the aid, is a moot question. According to the recent practice of the European Commission in the context of the financial crisis, when a government provides a liability guarantee, the amount of the aid is deemed equal to the amount of the guarantee. However, one could estimate the amount of the aid, or even its existence, differently. For instance, in the case of a fundamentally sound bank, the existence of the guarantee is enough to ensure that the beneficiary bank will have access to credit markets (on almost the same terms as governments) and will be able to meet its short term obligations, which rules out bankruptcy in the short run, and hence the calling of the guarantee. If, in addition, the bank is fundamentally sound in the sense that the market value of its assets (in all foreseeable post-crisis contexts) exceeds its total liabilities, bankruptcy is also ruled out in the long run. On the basis of such reasoning, one could argue that since the probability that the guarantee will be used is zero, it entails no cost for the government, and it thus does not constitute aid. Still, another reasoning could be based on the value of the guarantee for the recipient bank, i.e., the amount it would be willing to pay in order to obtain it, or alternatively, some measure based on past market benchmarks (such as the pre-crisis price of credit default swaps).

Whether a measure should be seen as aid usually depends on its degree of selectivity. An overall decrease in the level of corporate taxes is never seen as aid; conversely, a tax break granted to a specific firm is usually considered to constitute an aid. However, intermediate cases are often less clear-cut. For instance, determining whether a tax break targeted to small companies constitutes an aid involves a certain degree of arbitrary judgement.

Despite this uncertain delineation, the existing estimates, based on heterogeneous definitions, point to the large magnitude of subsidies and state aids. Subsidies have been following a global long-term downward trend, as most countries shifted away from government intervention to an increased reliance on market mechanisms, and as the financial requirements of health care and pension systems increasingly constrained budgets, leaving less room for other types of spending. However, the financial crisis caused a short-term upsurge, as governments bailed out distressed financial institutions and other companies.

The most comprehensive data about state aids are those covering the European Union. They show that in spite of a strict control over state aids, their total amount, excluding measures related to the financial crisis, was still €113.4 billion in 2008, or 0.94% of EU GDP.³ Not taking aid to railways into account, the

³ Report from the Commission, state aid Scoreboard, Autumn 2009 Update.

volume of aid has been halved between 1992 and 2008, from 1% to 0.54%. The inclusion of crisis measures changes the picture dramatically, since they amounted to €212.2 billion, or 1.7% of GDP.

The EU figures (even not taking crisis measures into account) show that even under a strict control regime, national governments are prone to providing sizable subsidies to companies. This alone, even absent very precise data about non-EU countries, suggests that the global amount of subsidies is likely to be very large.

Data about non-EU countries are less available and usually lack homogeneity. However, the figures that are available indicate the importance of state aids and subsidies. Aid to agriculture in OECD countries alone amounted to \$318 billion in 2002. Van Beers and van den Bergh (2001)⁴ also estimate worldwide subsidies to companies as representing 3.6% of world GDP in the mid 1990s. Another indication of the importance of subsidies is that out of the 63 cases brought before the WTO's settlement body between 2001 and 2008, 14, i.e., 22% of the total, concern subsidies.

Subsidies take a variety of forms. To mention just a few, global energy subsidies (including both the general subsidisation of energy, support to coal mining in many countries, and, conversely, support to renewable energies) are well above \$100 billion per year, with Iran's alone amounting to \$55 billion.

Some industries are particularly likely to receive subsidies, especially in times of crisis. For instance, total worldwide subsidies proposed for the car industry in 2008 were about \$48 billion, both in developed and developing countries. In addition to the US direct subsidy of \$17.4 billion to its three national companies, Canada, France, Germany, United Kingdom, China, South Korea, Argentina, Brazil, Sweden and Italy, among others, have also provided direct or indirect subsidies to their car industries which combined are very substantial. Other sectors, such as shipbuilding and airlines, are also regular recipients of subsidies, as recurring overcapacity reduces margins and causes governments to step in.

The motives for state aids are as varied as the nature of their recipients. Government subsidies have often been used to foster the development of new industries, in the context of an "offensive" industrial policy, especially in developing countries.⁵ This is the case for instance of Brazil's long-standing aid to the aircraft producer Embraer, initially an SOE that was later privatised, of the investments made by Fundacion Chile in many different sectors, and of the subsidies granted in the past by South Korea in order to encourage conglomerates diversification into many sectors. Subsidies granted to innovative clusters are another example of an offensive industrial policy.

Subsidies are also often granted as part of a "defensive" industrial policy, when they are targeted towards distressed firms, with the goal of preventing foreign takeover, avoiding the disappearance of an activity deemed essential for the country's economy, or avoiding layoffs and the ensuing social troubles. Examples include the recurring support to carmakers, airlines, and coal mining across the world. In some cases, governments grant subsidies to fragile sectors such as these because they feel compelled to do so in order to re-establish a competitive balance, given the subsidies granted by foreign governments.

Another motive for granting aid is to encourage activities deemed to generate positive externalities in addition to the private return to the company undertaking them. Examples include aid to renewable energies, aid to research and development, but also aid to investment in distressed regions.

⁴ C. van Beers and J. van den Bergh, 2001, Perseverance of Perverse Subsidies and Their Impact on Trade and Environment, *Ecological Economics*, vol. 36(3), 475-486.

⁵ See the documentation of the 2009 GFC Roundtable on Competition Policy, Industrial Policy and National Champions: <http://www.oecd.org/dataoecd/12/50/44548025.pdf>.

Countries also grant subsidies in order to attract greenfield investments, often by foreign firms. Such competition between national or local governments sometimes gives rise to subsidy races leading to the granting of considerable sums, both in developed and developing countries. Such subsidy races are particularly frequent in large federal countries.

1.2 *The treatment of state aids by the WTO*

State aids and subsidies seem to be at odds with the idea that market mechanisms, under free competition, are the best way to promote social welfare. State aids and subsidies interfere with price formation and with the “Darwinian” processes that competition fosters and that are usually considered to be one of the main forces leading to economic efficiency (at least if one believes in the principles underpinning competition policy). One could therefore expect them to be subject to the intense scrutiny of competition authorities worldwide. This is however not the case. Only in the EU does the competition authority (the European Commission) have the power to exert a stringent control over state aids. In some other jurisdictions, competition authorities have some control over the actions of public entities. However, by and large, starting with a global perspective on the approaches to controlling state aid, the discipline on state aid with the widest multilateral reach, is the one derived from the agreement on subsidies and countervailing mechanisms (hereafter, the “SCM agreement”) entered into by all WTO members at the end of the Uruguay Round.

The SCM agreement does not provide for any *ex-ante* control.⁶ It contains two broad sets of rules. “Track I” refers to the imposition by a Member State of countervailing duties on imports from another Member State granting a subsidy, if that subsidy hurts the duty-imposing country’s domestic industry. “Track II” rules allow a Member State to challenge a subsidy granted by another Member State before the WTO dispute settlement body.

According to the SCM agreement, a measure constitutes a subsidy if (i) it involves a financial contribution by the government, (ii) it confers a benefit upon its recipients, and (iii) it is specific to a company, an industry, or a group of industries. In practice, criterion (i) is interpreted broadly in WTO law, in that an instruction by the government to private companies to grant an advantage to some companies is considered sufficient for the criterion to be met, even without any actual cost to the government. In contrast, the selectivity criterion is interpreted quite narrowly. For instance, a measure benefitting only small companies, or only companies in a given region, is not considered to meet condition (iii).

Not all subsidies are illegal under WTO law. Once a measure is classified as a subsidy, it can be considered as a prohibited subsidy, or an “actionable” subsidy. Export subsidies and import-substitution subsidies are prohibited *per se* under WTO law. All other subsidies are actionable, meaning that in order for a country to impose countervailing duties or to challenge them before the dispute settlement body, it has to prove that the subsidy causes harm to itself.

Fourteen cases involving subsidies were brought before the dispute settlement body between 2001 and 2008. However, this number does not allow us to measure the true impact of WTO rules, which is mainly by deterring governments from granting aid in the first place.

⁶ For a detailed presentation of WTO rules and a discussion of their relationship to EU rules, see C.-D. Ehlermann and M. Goyette, 2006, The Interface between EU state aid Control and the WTO Disciplines on Subsidies, *European state aid Law Quarterly*, vol. 2006 (4), 695-718.

1.3 *State aid control in the European Union*

Stringent control over state aids is exerted by the European Commission. State aid control in fact predates the creation of the EU (then the “European Community”) in 1957, since it was already an essential part of the treaty instituting the European Coal and Steel Community in 1951 (with the same six founding members as the European Community, i.e., France, Germany, Italy, Belgium, the Netherlands and Luxemburg). At the time, the main rationale of state aid control was market integration between the Member States.⁷ In particular, state aid control was meant to prevent artificial vertical integration on a national basis, with each coal producer selling under preferential terms to steel producers in the same country.

Article 107(1) of the Treaty on the Functioning of the EU prohibits state aid which distorts or threatens to distort competition in so far as it affects trade between Member States. However, state aid contributing to well-defined objectives of common European interest without unduly distorting competition between undertakings and trade between Member States may be considered compatible with the common market (Article 107(3)). A major difference between EU and WTO disciplines is that EU control takes place *ex ante*: a Member State planning to grant aid or to enact a measure that might constitute an aid (in case its characterisation as aid is uncertain) must start by asking for the Commission’s permission. A major similarity is that each respective regime applies only to state aids where the distortion to competition occurs (at least partly) within the countries that are party to the respective arrangements.

In practice, especially after the issuance of the state aid Action Plan in 2005, the Commission’s way of handling individual cases revolves around the “balancing test”. The main elements of this test are, on the one hand, the identification of the objective of the aid, an examination of whether the aid measure is an appropriate policy instrument (in the sense that it will achieve the purported goal and no less distortive measure could achieve the same goal), and finally, a balancing between the expected positive impact of the aid and the expected competition distortions.

The first step of the analysis often involves the identification of market failures, which the aid measure is meant to correct. This is consistent with the general philosophy underlying competition policy, namely the idea that markets in general deliver efficiency. The second test is very important in practice. For instance, in cases where an aid measure is meant to compensate a company for the provision of a “service of general economic interest”, it usually leads the Commission to ask why an open, non-discriminatory tender (not considered to constitute aid since the Altmark ruling⁸) could not meet the same goal as the aid. In other words, the second leg of the test strongly restricts governments’ ability to grant aid.

These general principles have been the foundation of the various guidelines published by the Commission in the last years, covering different types of aid such as the General Block Exemption Regulation, guidelines on aid to research and development, on aid to promote risk capital investment in small and medium-sized enterprises, on aid for environmental protection, and on regional aid etc (this list is not exhaustive). With the commencement of the financial crisis in August 2008, the Commission also published rescue and restructuring guidelines, and various communications on the handling of the financial crisis, including as a starting point the “Commission communication on the return to viability and the assessment of restructuring in the financial sector in the current crisis under state aid rules”. It also issued guidelines about aid in response to the crisis in the real economy (i.e., aid to non-financial companies negatively effected by the dramatic reduction of available credit), with the “Temporary Framework for state aid measures to support access to finance in the current financial and economic crisis”.

⁷ G. Grin, 2003, *The Battle of the Single European Market: Achievements and Economic Thought, 1945-2000*, London : Kegan Paul.

⁸ Case C-280/00 Altmark Trans GmbH, Regierungspräsidium Magdeburg v Nahverkehrsgesellschaft Altmark GmbH [2003].

While EU rules are generally perceived to be more stringent than WTO rules, this is not always the case. For instance, according to the European Court of Justice, a measure by which the government imposes an obligation to private entities to subsidise other private entities is not considered an aid under EU rules if it does not imply a direct cost to the government.⁹ It is also noted that an element of the EU law is that it affect trade between the Member States (which is, of course, a smaller grouping of countries than the WTO).

A point worthy of attention is that the notion of affectation of trade between Member States or of distortion of competition by the Commission or Courts has evolved over time. To start with, the standard of proof has changed. Before the ruling of the Court of First Instance (CFI) in *Tubemeuse*¹⁰, the European Commission tended to consider that these conditions were necessarily met as soon as aid was granted and that they therefore did not warrant a specific investigation. In that ruling, the CFI confirmed a decision of the European Commission prohibiting an aid granted by the Belgian government even though the recipient was selling mostly outside of the EC. It held that neither the importance of intra-European trade in the affected market, nor the magnitude of the aid, mattered for the finding of a risk of trade distortion or affectation of trade between Member States. The CFI also claimed that “*the relatively small amount of aid [...] does not as such exclude the possibility that intra-Community trade might be affected*”. The CFI thus considered that while the European Commission needed to formally address the competition distortion and affectation of trade conditions, it was subject to a very low standard of proof, in that it was enough for the European Commission to show that distortion of competition or affectation of trade could not be ruled out *a priori*.

The recent *Wam*¹¹ ruling may represent a turning point. While it is not the first ruling annulling a prohibition decision by the Commission, it did so by setting a standard of proof that appears to be more demanding than in most of the previous case law. The Court stated that the fact that the aid recipient was engaged in intra-European trade was not by itself sufficient for the Commission to conclude that the aid was going to affect trade between Member States: “*The mere observation that Wam participates in intra-community trade is insufficient to conclude on trade affectation or distortion of competition, and an in-depth analysis of the effect of aids is necessary.*”¹²

Beyond the issue of the standard of proof, the very meaning of these notions of competition distortion and affectation of trade has evolved over time as well. In *Philip Morris*¹³, the CFI held that competition distortion relates to a change in the position of an undertaking compared with other undertakings in intra-Community trade. But in the Framework for Research, Development and Innovation (FRDI) the European Commission also mentions changes in the location of economic activity as a possible distortion¹⁴, even though such changes may occur independently of any impact on competitors (for instance in the case of the granting of aid to a monopoly not threatened by potential entry).

The Commission’s views as to which market structures make competition distortion more likely have also evolved over time. In several cases (*Imepiel*¹⁵, *Ramondin*¹⁶), distortion was considered more likely if

⁹ Case C-379/98 – *PreussenElektra AG v. Schleswag AG*, [2001] ECR I-2099.

¹⁰ Case 102/87 [1988] ECR 4067.

¹¹ CFI, 6 September 2006, *Italy and Wam SpA v Commission*, case T 304/04.

¹² Author’s translation of “*le seul constat de la participation de Wam aux échanges intracommunautaires est insuffisant pour étayer une affectation desdits échanges ou une distorsion de concurrence et, dès lors, nécessite une analyse approfondie des effets des aides.*” (point 74).

¹³ Case 730/79 [1980] ECR 2671.

¹⁴ R&D&I Framework, point 7.4.

¹⁵ OJ L 172/76, 27/06/1992.

the affected market was highly competitive. This was even stated as a point with general relevance in the motor vehicle guidelines, as the Commission recalled in the DAF Trucks Decision: “*Under aid for modernisation and innovation, the guidelines stipulate that 'in the context of a genuine internal market for motor vehicles, competition between producers will become even more intense and the distortive impact of aid will be greater. Therefore, the Commission will take a strict attitude towards aid for modernisation and innovation'.*”¹⁷ However, in its recent R&D&I Guidelines, the Commission takes a different view, claiming that the distortion of dynamic incentives or State-aid-driven market power creation are less likely in highly competitive markets.¹⁸

State aid control in the European Union has progressively shifted from a purely legalistic approach towards an effects approach. This evolution, in the jurisdiction with the longest state aid control experience, testifies to the need for a better assessment of the economic consequences of state aid and subsidies across countries.

1.4 State aid control and control over government agencies outside of the EU

Some regional trade blocs also have specific state aid control rules. For instance, the West African Economic and Monetary Union (“WAEMU”), which regroups Benin, Burkina Faso, Côte d’Ivoire, Guinea Bissau, Mali, Niger, Senegal and Togo, adopted in 2002 competition guidelines, which prohibit anti-competitive agreements, abuses of a dominant position, and “public subsidies liable to distort competition by favouring specific companies or products”. However, according to the WAEMU contribution, these rules have yet to be enforced efficiently, which would require greater support from the member states.

Other free trade zones, such as the Andean Community, have rules restricting subsidies since Decision 45725 aims at preventing or correcting the distortions in competition generated by subsidies in imports that are produced in Member States.¹⁹

Some domestic competition authorities in non-EU countries also have at least nominal authority over state aids. For instance, Russian competition legislation is applied not only to enterprises but to State executive authorities as well, which is the basis for state aid control in Russia. According to Articles 7 and 8 of Russia’s antimonopoly law, actions and agreements of the bodies of executive authority that limit the economic independence of enterprises, create favourable or discriminatory conditions for certain enterprises shall be prohibited. A recent legislative change granted the Antimonopoly authority the power of preliminary control over the adoption of decisions of the bodies of executive authority. Decisions on the granting of any privileges to specific enterprises or groups of enterprises need approval by the Antimonopoly authority.

China’s Antimonopoly Law which came into effect in 2008 includes a whole chapter comprising six separate prohibitions against certain forms of abuse of administrative power to eliminate or restrict competition. These prohibitions explicitly refer to some governmental initiatives (e.g., setting discriminatory inspection standards or undertaking repeated inspections in a discriminatory way) that may extend beyond the European definition of state aid.

Competition authorities in countries currently in the process of joining the EU, such as Croatia and Turkey, also have some control over state aids. In addition, several countries (such as Pakistan and Peru,

¹⁶ OJ L 318/36, 16/12/2000.

¹⁷ OJ L 015 , 20/01/1996 P. 0037 – 0045.

¹⁸ Sections 7.4.1. and 7.4.2.

¹⁹ <http://www.comunidadandina.org/normativa/dec/D457.htm>

among others) indicated in their submissions for this GFC roundtable that competition law applies to SOEs, but also more generally to public entities.²⁰

Finally, many countries, such as Brazil, Australia, Hungary, Peru and Norway, have laws that provide for a “competitive neutrality principle” applicable to government agencies and SOEs²¹. “Competitive neutrality” generally means that Government businesses should not enjoy any net competitive advantage vis-à-vis other businesses simply as a result of their public sector ownership.²² In some cases there are complaints mechanisms handled by agencies with competition responsibilities available to private companies and private individuals.²³ In addition, competition authorities in many countries are consulted on matters possibly involving state aids, for instance, on the design of public tenders or of privatisation processes.

1.5 Where subsidies meet competition law: predatory pricing and merger control

As well as the various regimes that directly apply to state aid discussed above, the enforcement of competition policy even within its “traditional” boundaries can lead competition authorities to deal with state aids, at least indirectly, in two sets of circumstances (even in the absence of legal instruments attaching directly to state aid).

The first, and most frequent one, is when companies (often, but not always SOEs) use government subsidies in order to engage in predatory pricing or other exclusionary behaviour. In the EU, the landmark case illustrating this issue is *Deutsche Post*.²⁴

At the time of the practices at stake (the 1990s), Deutsche Post was an SOE active on two very different markets. On the one hand, it handled letter mail monopoly in Germany, at government-regulated prices, providing a government-regulated public service. On the other hand, Deutsche Post was active on the business parcel delivery market, which was open to competition, in particular that from United Parcel Service (UPS), Federal Express, and other private companies. UPS complained to the European Commission that Deutsche Post was using letter mail monopoly profits to subsidise the sale of its parcel delivery services at below-cost prices. In March 2001, the EC found that for five years Deutsche Post failed to cover incremental costs in its pricing of parcel delivery service, thereby abusing its dominant position.

At first glance, one might consider that there is no dearth of predatory pricing cases and that there is nothing special about the predatory company being a SOE. This impression is misleading, however, because of two specificities of SOEs. First, the definition of the incremental costs associated to the activity on the competitive market depends on which costs are attributed to the public service. The *Deutsche Post* decision clarifies that all costs that are necessary to the meeting of public service obligations should be ascribed entirely to these obligations, even if they also contribute to the activities exerted on the

²⁰ See <http://www.oecd.org/competition/globalforum>.

²¹ Add reference to the October 2009 OECD work on SOEs.

²² See for example, the Competition Principles Agreement between the federal, state and territory governments in Australia.

²³ The same agreement provides that each member government must provide a complaints mechanism. In the case of the federal government it is Competitive Neutrality Complaints Office the Productivity Commission and in the case of regional governments include agencies such as the Queensland is the Queensland Competition Authority, Victorian Competition and Efficiency Commission and the Independent Competition and Regulatory Commission of the ACT.

²⁴ Case COMP/35.141 (2001/354/EC).

competitive market. Similar cases involved the former telecommunication monopoly in South Africa, Telkom, which was accused of using the profits derived from its monopoly over regulated voice services in order to cross-subsidise its Internet access broadband, leading to the predatory pricing of broadband services. The contribution from Peru also mentions similar cases: “to date, there have been six cases (...) in which the plaintiffs claimed that a State-owned hospital was providing medical services to patients which otherwise will be attended in private hospitals.”

Implementing the *Deutsche Post* criterion is sometimes complex. For instance, in a recent case involving maritime transportation between a French island and mainland France, where an expensive (and highly subsidised) vessel was used for the provision of both a regulated and subsidised public service (winter transportation) and a service in a competitive market (summer transportation), the predatory pricing test revolved around the following question: should the entire cost of the vessel be ascribed to the public service obligation, or should part of it be considered part of the incremental cost of providing the service on the competitive market (summer transportation), given that a smaller vessel could have been sufficient for winter transportation?²⁵ These examples show that even when addressing a standard, “traditional” antitrust concept such as predatory pricing, competition authorities may be led to assessing the cost of providing a regulated public service – which is very close to what the European Commission does when assessing whether government compensation for services of general economic interest constitutes a subsidy.

A second difference between SOEs and private companies, as regards predatory pricing claims or more general claims of exclusionary behaviour is that SOEs’ objectives are often not profit maximisation, but rather the maximisation of some combination of profits and size.²⁶ This implies that even in situations where exclusionary behaviour is incompatible with the maximisation of the discounted flow of future profits (say, because recoupment is unlikely after the elimination of a competitor, due to the absence of entry barriers), SOEs may nevertheless be tempted to engage in such behaviour, while private companies in the same situation would not. This observation has prompted some authors to argue that the treatment of exclusionary abuses should be stricter when the defendant is an SOE, and that the “recoupment” test, which is part of the assessment of predatory pricing claims in the US, would lead to overly lenient enforcement.²⁷

Another, less direct relationship between subsidies and competition policy is in the field of mergers. Governments wanting to deter some mergers between private firms, for “industrial policy” or economic nationalism reasons can in some cases threaten a reduction in subsidies, or more generally a worsening of the terms of trade with the government (in the case of firms selling to government entities, or at government-regulated prices, or purchasing some inputs from public entities). For instance, it is sometimes alleged that when the Swiss pharmaceutical company Novartis and the French pharmaceutical company Sanofi competed for the acquisition of Aventis, the French government leveraged its influence over drug price negotiations in order to favour a merger between two French firms. This is consistent with the empirical observation that countries with a high share of foreign firm ownership tend also to impose relatively high corporate taxes.²⁸

²⁵ French Competition Authority, Decision #04-D-79 ; Cour de cassation ruling, 17 June 2008.

²⁶ See, e.g., W. Niskanen, 1971, *Bureaucracy and Representative Government*, Aldine Transaction; William Niskanen, 1975, Bureaucrats and Politicians, *Journal of Law and Economics*, vol. 18.

²⁷ D. Sappington and G.Sidak, 2003, Competition Law for State-Owned Enterprises. *Antitrust Law Journal*, vol. 71 (2), 479-523 ; 2000, Are Public Enterprises the Only Credible Predators?, *University of Chicago Law Review*, vol. 67 (1), 271-292.

²⁸ H. Huizinga and G. Nicodème, 2006, Foreign ownership and corporate income taxation: An empirical evaluation. *European Economic Review*, 1223-1244.

In spite of the abovementioned interactions between competition law and subsidies, the general observation is that, outside the European Union, there is relatively little control over state aids, since WTO disciplines only cover some categories of aid (those that cause harm to other countries and give rise to complaints before the dispute settlement body). This invites a discussion of the impact of state aids. A review of the possible adverse impact of state aids, and the circumstances possibly justifying their use will now follow.

2. The possible adverse impact of state aids

2.1 *A background element: the cost of public funds*

Before considering the possible usefulness of state aids and subsidies, it is important to remember that collecting public funds entails cost, both direct (administrative) and indirect (due to the distortive effect of taxation) and that the granting of aid comes at the expense of other, possibly highly productive public expenditures.

According to some empirical estimates, raising 100 dollars for the government entails a deadweight cost between 18 and 24 dollars: when the government raises 100 dollars, other economic agents lose not 100 dollars, but between 118 and 124 dollars.²⁹ These figures are for the United States and one can suppose that the cost of public funds is greater in developing countries.

On the expenditure side, the magnitude of subsidies is so large in some developing countries that reducing them would allow governments to dramatically increase their spending on health care or education. For instance, by diverting SOE operating subsidies (which are just a part of the total subsidies granted by governments to companies) to basic education the central governments of Mexico, Tanzania, Tunisia and India could increase central government education expenditures by 50, 74, 160 and 550 percent, respectively. Likewise, redirecting SOE subsidies to health care would permit the central government of Senegal to more than double health care expenditures in that country, and the central governments of Turkey, Mexico, Tunisia, and India to increase health care expenditures threefold, fourfold and fivefold, respectively.³⁰

These numbers are important because they imply that the opportunity cost of state aids is very large. According to existing estimates, the social return to public investment in education is about 8.5% in OECD countries, but above 20% in developing countries.³¹ These numbers imply that state aids should be assessed against a strong standard. Aids that are tantamount to pure lump-sum transfers represent an enormous waste of resources (unless the lump-sum transfers contribute to some legitimate, well-identified distributive goal) since they use public funds that are costly to collect and that could have been put to a much more productive use had they been allocated to health care or education.

²⁹ C. Ballard, J. Shoven and J. Whalley, 1985, General Equilibrium Computations of the Marginal Welfare Costs of Taxes in the United States, *American Economic Review*, vol. 75 (1), 128-138; D. Jorgenson and K. Yun, 1990, Tax Reform and US Economic Growth, *Journal of Political Economy*, vol. 98 (5) ; D. Jorgenson et K. Yun, 1991, The Excess Burden of Taxation in the United States, *Journal of Accounting and Finance*, vol. 6 (4), p. 487.

³⁰ D.A.C. Smith, and M.J. Trebilcock, 2001, State-owned Enterprises in Less Developed Countries: Privatization and Alternative Reform Strategies, *European Journal of Law and Economics* vol. 12 (3), 217-252.

³¹ G. Psacharopoulos and H.A. Patrinos, 2004, Returns to investment in education: a further update, *Education Economics*, vol. 12 (2), 111-134.

2.2 *The magnitude and economic cost of subsidy races*

One may wonder why governments would grant subsidies when more efficient uses of public funds would be possible.

A frequent answer has to do with the existence of negative externalities between jurisdictions, i.e., between countries or between regions within countries. In a nutshell, the granting of aid may seem to be sound policy from the narrow viewpoint of a local or a national government, but when such aid amounts to shifting economic activity from one region (or one country) to another one, it is globally almost useless and it amounts to a waste of public funds.

The deadweight cost of taxation and the opportunity cost of public funds are high and therefore state aids are likely to be wasteful even when they do not directly generate distortions (the observation that state aids, in addition, often generate serious distortions that are damaging to economic efficiency and to the environment, is explored later on in this study).

The mechanism behind the externality is the following. A firm's decision to set up, expand or maintain a plant in a country often generates sizable benefits for the host country or the host region: tax revenues (levied directly on the firm or indirectly, on employees' salaries), possibly a decrease in unemployment and in the associated costs, increased demand for the output of local suppliers, etc. It may also result into a transfer of skills to the local workforce, which can then benefit the economy more broadly as workers change firms. Each national or local government thus may have an interest in granting aid in order to lure firms into its territory. Competition across local or national governments wanting to attract or retain the same firms might result in large volumes of aid, shifting the location of firms' activities rather than creating new ones.

In theory, subsidy races might raise, rather than decrease, total welfare. This could be the case if two conditions were met: (i) the deadweight cost of taxation and the opportunity cost of government funds are low and (ii) the benefit derived from a firm's presence varies greatly across locations. In such a case, the countries or regions in which the presence of a firm would yield the largest benefits are willing to "bid" greater amounts than regions in which these benefits would be smaller. Just like price competition, cross-country competition would then reveal where the external benefits are greatest, and it would cause firms to locate where their presence is most valuable, which would be desirable.^{32]}

If, as is generally the case, the deadweight cost of taxation and the opportunity cost of government funds is large (which is the case, as is explained above), and if subsidy races do not direct investments towards regions where they have the greatest positive external impact, then races are likely to be wasteful.

The available literature about the United States, where aid is not prohibited illustrates that competition across states to attract firms can be costly. States seem to engage in significant competition to shift activities from neighbouring states to themselves, often without creating new activities.³³ Simply changing the location of a business (as opposed to encouraging the creation of new activity) is unlikely to have net beneficial effects unless there is a markedly different cost / benefit balance in different regions within the

³² W. Tiebout, 1956, A pure theory of local expenditures, *Journal of Political Economy*, vol. 64 (5), p. 416; T. Besley and P. Seabright, 1999, The Effects and Policy Implications of state aids to Industry: an Economic Analysis, *Economic Policy*, p. 15-53.

³³ R. Tannenwald, 2002, Are State and Local Revenue Systems becoming Obsolete?, *National Tax Journal*, vol. 55 (2), p. 467.

one country. This cross-state competition also seems to have intensified lately,³⁴ and this has prompted some American authors to recommend a federal control over state aid.³⁵

Even in the European Union, where state aid control is supposed to limit the occurrence of wasteful subsidy wars, and where one could expect subsidy competition to result only in “virtuous” outcomes, i.e., in directing investments where it generates the greatest positive externalities, the evaluation by the literature of existing aids is not very positive. According to a recent study, while regional policy aiming to attract firms to poor or peripheral locations apparently succeeded, they were very costly because the distortion of firms’ location choices resulted into sizable inefficiencies.³⁶ The case for state aid as a tool for the alleviation of regional inequalities might thus not be so strong, and alternative policies, such as direct income transfers could be more efficient in many cases.³⁷

The picture is not different in the developing world, where examples of highly wasteful subsidy competition abound, often within large, federal countries, where regional governments try to outbid each other in order to attract investment.

A recent example is the competition between various Indian states in order to attract a plant that Tata Motors was willing to build in order to produce a new, cheap car destined primarily for the Indian market. The location of the plant was finally decided to be in the state of West Bengal, after this state’s government offered a highly attractive incentive package including preferential loans at a below-market rate of 1%, subsidised electricity (with a discount greater than 25%), subsidised land, and tax exemptions.

More interestingly, this example illustrates the intensity of competition across states. In particular, during the “bidding war”, West Bengal offered a commitment to match the incentive packages offered by two other states (Uttarakhand and Himachal Pradesh). If, as is probably the case, what was at stake was the location of the plant, rather than the principle of its existence somewhere in India, it is likely that such a subsidy race was inefficient unless the cost / benefit balance varies considerably within the one country.

This example is far from being isolated in developing countries. For instance, there has been in the late 1990s an intense subsidy war across Brazilian states trying to attract automotive plants.³⁸ For instance, in 1995 and 1996, the state of Parana and the municipality of Sao Jose offered Renault an attractive package, including a capital contribution of about \$ 300 million and subsidised electricity, launching what became known as the “fiscal war” across Brazilian states.

Similar subsidy wars have taken place in East Asia as well. In 1996, Thailand and the Philippines engaged into a hard-fought battle to attract a General Motors car plant. In the end, Thailand won the contest by matching the Philippines’ package and, in addition, offering a 100 per cent refund on raw materials for car exports and a \$15 million grant towards setting up a General Motors training institute.

³⁴ K. Chi and D. Leatherby, 1997, *State Business Incentives: Trends and Options for the Future*, Lexington, Kentucky: Council of State Governments.

³⁵ P. Enrich, 1996, Saving the States from Themselves: Commerce Clause Constraints on State Tax Incentives for Business, *Harvard Law Review*, vol. 110 (2), p. 377.

³⁶ K.-H. Midelfart-Knarvik and H.-G. Overman, 2002, Delocation and European Integration: Is structural spending justified?, *Economic Policy*, vol. 35, 322-359.

³⁷ K.-H. Ulltveit-Moe, 2007, Regional policy design: An analysis of relocation, efficiency and equity, *European Economic Review*, vol. 51, 1443-1467.

³⁸ This and the following examples are drawn from Andrew Charlton, 2003, Incentive Bidding for Mobile Investment: Economic Consequences and Potential Responses, OECD Development Centre, Working Paper No. 203.

Again, the interesting element is that General Motors had announced its intention to build a \$ 500 million car plant in Asia, irrespective of subsidies. Therefore, the subsidies did not, in all likelihood, contribute to the creation of new economic activities, and simply had an impact of the location of a plant that would have been built notwithstanding the subsidies provided.

Such subsidy wars are by no means limited to the car industry. Since the mid-1990s, several East Asian nations have launched various incentive schemes, involving very generous tax exemptions for high technology investments.

One may question the economic rationality of such subsidy races, both at the individual level of the country or regions granting a subsidy, and at a more global level.

At the individual level, since such subsidy races are mostly about attracting foreign investment (though not only, as the Tata Motors example shows), the relevant question is whether foreign investment generates large enough externalities to make the granting of subsidies rational. There is evidence that foreign direct investment generates benefits to other firms in the same sector or in vertically related ones (i.e., suppliers or customers). This evidence is so far more abundant in the case of developed countries. In the case of developing or transition economies, there is a (still admittedly small) body of evidence showing that the presence of affiliates of foreign-owned firms tends to increase the productivity of their local suppliers, but the evidence also shows that such effects vary a lot from one case to another.³⁹

These findings imply that it may be rational for individual countries or regions to grant large subsidies in order to attract foreign investment. However, such behaviour is likely to be collectively irrational, in that a “prisoner’s dilemma” is at play. In the end, most of the investments benefitting from subsidies would have taken place anyway, so that the main impact of subsidy races is a waste of public funds.

2.3 Strategic subsidisation in oligopolistic sectors: overcapacities and competition creation

In oligopolistic markets, state aid may also generate cross-country externalities by having an impact on the investment decisions of the rivals of the aid recipient. The underlying mechanism has been studied in the economic models of strategic trade policy,⁴⁰ and can be summarised as follows. In an oligopoly, in which firms earn rents derived from their market power, a firm’s profit increases if its rivals decrease their investment (to be understood in a broad sense, including R&D, advertising, set-up costs in order to operate in a new country, etc.) Therefore, a national government may have an interest in inducing the foreign rivals of one of its national champions to scale down their investments.⁴¹ State aid may achieve this result in some circumstances. For example, if country A grants investment aid to a firm, competitors in country B may expect an expansion of the recipient of the aid, and thus a reduction in the residual demand facing them. This expectation may in turn induce them to scale down their investment. The overall result is a shift of part of the oligopoly rents towards the recipient of the aid, at the expense of its rivals.⁴²

³⁹ B. Javorcik, 2004, Does Foreign Direct Investment Increase the Productivity of Domestic Firms? In Search of Spillovers Through Backward Linkages, *American Economic Review*, 2004, vol. 94(3).

⁴⁰ J. Brander and B. Spencer, 1985, Export Subsidies and International Market Share Rivalry, *Journal of International Economics*, vol. 18, p. 83.

⁴¹ See GFC 2009 Roundtable on Competition Policy, Industrial Policy and National Champions (cf. Footnote 6 above).

⁴² In some circumstances, the causality may be reversed. For example, a firm facing a decrease in its residual demand may have greater incentives to engage into R&D so as to re-establish a better market position.

The granting of aid may thus allow the recipient to pre-empt a part of the demand which, absent any aid, would have been served by foreign rivals. This mechanism involves a cross-country negative externality because when a government grants aid, it fails to take into account the harm to foreign competitors.

Such logic is probably at work in sectors such as the automotive industry. As recalled above, governments across the world, in developed and developing countries alike, have granted massive subsidies to their automotive industries, with the total commitments estimated at \$ 48 billion in 2008. Many governments justify the granting of aid by the need to re-establish competitive balance and to compensate for the subsidies granted by foreign governments.

In theory, the impact of such subsidies on social welfare is ambiguous, because they may generate a positive cross-country externality: if the recipient of aid expands production, or investment, consumers may benefit, not only in the country whose government granted the aid, but also abroad. A government caring only about the welfare of domestic economic agents would fail to take this effect into account. If this positive externality is more important than the abovementioned negative one (the one on foreign producers), it could be the case that, even absent state aid control, governments grant too little, rather than too much aid!⁴³

Leaving theory aside, it is clear that such strategic subsidies impose a large cost to the global economy, at least in the automotive sector, because they hinder the much-needed balance between production capacities and global demand.

This result is however not universal. In some cases, especially when the subsidy is used in order to create a new competitor in a market lacking competition, it may be welfare-increasing. The positive externality at stake is the impact on the degree of competition. For instance, creating Airbus yielded benefits not only in the form of profits from the sale of aircraft, but also in the form of a decrease in the (quality-adjusted) prices of Boeing aircraft, which shifted monopoly rents away from US shareholders to airlines around the world (and their clients). The same can be said of the creation of Embraer, the Brazilian aircraft producer. The main finding from empirical research is that the impact of such competition-creation subsidies is very complex and multidimensional. For instance, it has been estimated that because of the increased competition in the aircraft sector fostered by the creation of Airbus, the corresponding subsidies significantly raised European welfare, but decreased the global economic surplus (once the losses to pre-existing aircraft manufacturers are accounted for).⁴⁴

2.4 Distortions caused by subsidies

The main source of inefficiency caused by subsidies, besides their possible wasteful nature (in which case the inefficiency results from the opportunity cost of public funds) is that they tamper with market signals. This can result in two types of inefficiencies. *Allocative inefficiencies* arise when the relative quantities produced and consumed of various goods are not optimal. Technical inefficiencies arise when, taking total output as given, production does not use the cost-minimising combination of inputs (taking environmental costs into account).

⁴³ D. Collie, 1998, State aid in the European Union: The prohibition of subsidies in an integrated market, *International Journal of Industrial Organization*, vol.18, 867-884; D. Collie, 2002, Prohibiting State aid in an Integrated Market, *Journal of Industry, Competition and Trade*, vol. 2 (3), p. 215; D. Collie, 2005, State aid to Investment and R&D, *European Economy, Economic Papers*, vol. 231, p. 1.

⁴⁴ D. Neven and P. Seabright, 1995, European Industrial Policy: the Airbus Case, *Economic Policy*, vol. 21, 313-358.

This interference with market signals can take two broad forms. When state aids amount to a general, across-the-board subsidisation of inputs, the inefficiency results from the discrepancy between the prices perceived by economic agents, which are affected by subsidies, and the “true”, cost-based prices.

When state aids target specific firms, they alter the “Darwinian” mechanism by which capital is allocated to the most efficient firms, which tends to minimise total production costs. This effect can play both at the intra-sectoral and at the inter-sectoral level. At the intra-sectoral level, state aids may channel capital and labour to less efficient firms, thereby generating productive inefficiencies. At the inter-sectoral level, state aids may affect the relative magnitude of various sectors, leading to overproduction in subsidised sectors and underproduction in others.

These various mechanisms are highlighted hereafter with the help of a few examples. For illustrative purposes, we focus on examples from developing countries and on distortions having an impact on the environment. We also consider a few examples drawn from the recent financial crisis and bank bailouts.

2.4.1 Price distortions

The most striking example of economically and environmentally costly distortions caused by subsidies is that of energy subsidies.

These subsidies are quantitatively important, both on the consumption and on the production side, in developing and developed countries alike. Iran’s fuel subsidies amount to about \$ 55 billion per year. India’s fuel subsidy has been estimated at \$ 15 billion annually at least, 90% of which accrue to agriculture. Quite interestingly, large fossil fuel producers and exporters are most likely to heavily subsidise energy consumption: beyond the extreme case of Iran, Saudi Arabia and Venezuela, two of the world’s largest oil producers, are also among the most important providers of domestic energy subsidies (\$ 26 billion and \$ 17 billion annually)⁴⁵. The reason is probably that such subsidies are perceived as almost costless by governments. They are costly when the market price of oil is high, which also happens to be the time when governments earn large revenues from oil exports.

Even in the European Union, despite the existence of strict state aid control mechanisms, some fossil fuels benefit from very large production subsidies. Over the decade 1994 to 2005 over €80 billion in state aid for the coal industry was approved. In Germany the operating aid in 2004 was equivalent to over €86 per tonne suggesting that the cost of German coal production was more than twice the world market price. On the consumption side, the persistence of a complex scheme of regulated electricity prices in France, well below the true marginal costs of electricity generation, is another case of tampering with price signals.⁴⁶

Such subsidies have hugely distortive effects. On the consumption side, the long-term elasticity of demand for gasoline has been estimated to be around -0.7 in the sense that a 1% decrease in the price of gasoline causes demand to rise by 0.7% in the long run.⁴⁷ This relatively large number (in absolute value) implies that the abovementioned subsidies have a sizable impact on oil consumption. From a purely economic viewpoint, they tend to discourage conservation efforts and induce economic agents to behave without taking into account the true marginal production costs of fossil fuels. They are also environmentally damaging since they directly counter efforts to limit emissions.

⁴⁵ International Energy Agency, 2008.

⁴⁶ D. Spector, 2007, *Electricité: Faut-il désespérer du marché?*, Editions Rue d’Ulm.

⁴⁷ J. Hamilton, 2008, Understanding Crude Oil Prices, NBER Working Paper #14492.

The case of energy subsidies to Indian farmers is particularly interesting. The provision of cheap electric power since the 1970s was meant to support farmers (which formed, and are still forming the majority of the population, and are overwhelmingly poor) and encourage them to purchase and operate pumps to irrigate their crops. Obviously, the subsidisation of electric power meant that in many cases, the ensuing production decisions, while individually rational, were in fact value-destroying if considered on the basis of the true costs of electricity generation. This subsidisation policy also generated environmental damages. Because the cost of pumping water was artificially lowered, many farmers planted thirsty crops, which depleted water resources and increased salination.⁴⁸

The case of European coal subsidies illustrates the various channels by which subsidies can be distortive. In principle, the level of subsidies was calculated so as not to change the “merit order” between different types of fuels, i.e., in order not to make coal-fired power plants artificially more economical than, for instance, gas-fired power plants. This limit on the subsidy plan was one of the reasons that led the European Commission to accept it. However, even with this restriction, the subsidy scheme was bound to create distortions. The reason is that it amounts to increasing the global supply of coal, i.e., to adding an artificially inflated amount of European coal on the global market, with the consequence of lowering the market-clearing price, thereby generating some substitution away from other energy sources towards coal.

Coming second just behind energy, water is probably the most heavily subsidised commodity in the world. In the developing world alone, it is considered that water subsidies amount to about \$ 45 billion annually, leading to overconsumption and lack of investment in pipe networks (to reduce leaks).

2.4.2 *Productive and environmental inefficiencies caused by capital misallocation*

Another important source of inefficiencies concerns the provision of selective subsidies to specific firms – in particular SOEs. The source of the inefficiency is that if such subsidies are directed to inefficient firms, they shift production towards less efficient units, thereby increasing total production costs. This can also entail large environmental costs, since inefficient firms tend to use more inputs per unit of output, and hence to pollute more.

The order of magnitude of the subsidies to SOEs is very large. The fact that, in some countries, almost the entirety of subsidies were allocated to loss-making companies is consistent with the view that subsidies were often not allocated on the basis of a cost/benefit calculation, or by taking into account the presence of market failures in need of corrections, but merely by the need to keep inefficient production units afloat.

In addition to direct government subsidies, SOEs are often supported by preferential access to credit from state-owned banks.⁴⁹ These direct and indirect subsidies are directing resources to inefficient production units, implying a deadweight cost which can represent a non negligible percentage of industrial output.⁵⁰ This estimate is striking because it is an average across all SOEs, some of which are very efficient, especially after the Chinese government started to reform them by introducing private-sector style corporate governance rules.

⁴⁸ R. Tongia, 2007, *The Political Economy of Power Sector Reform in India*, in *The Political Economy and Institutions of Power Sector Reform in the Developing World*, Victor, D. and Heller, T. (eds.), Cambridge University Press, Cambridge.

⁴⁹ L. Brandt and Z. Zhu, 2000, *Redistribution in a Decentralized Economy: Growth and Inflation in China Under Reform*, *Journal of Political Economy*, vol. 108, 422–439.

⁵⁰ S. Claro, 2005, *How Uncompetitive is the State-Owned Industrial Sector in China*, Documento di Trabajo N° 305, Pontificia Universidad Católica de Chile, Instituto de Economía.

In addition to this purely economic deadweight cost, the subsidisation of inefficient SOEs causes significant environmental costs. A burgeoning but convergent empirical literature finds that SOEs tend to be less environment-friendly than private firms. Some studies⁵¹ find that SOEs can emit up to ten times more pollutants than private firms, everything else being equal. One of the reasons seems to be that SOEs are less monitored for environmental compliance than private firms⁵². But another likely reason is that since subsidies keep inefficient production units in activity, these units use up more inputs in general for a given amount of output, implying that they also pollute more.

Aid recently granted to financial institutions by many governments around the world can also have other sub-optimal effects. Government support was mainly directed to the larger banks, deemed essential for systemic stability. The result was that large banks had better access to credit than smaller ones, because creditors felt that they benefitted from an implicit government guarantee. According to a recent estimate, banks with more than \$100 billion in assets are borrowing at 0.34 points lower than other banks. This may induce a squeeze and further strengthen the larger banks at the expense of their smaller rivals. This creates an inefficiency, and it was the sheer size of the largest banks, and the perception that they were ‘too big to fail’, which acted as a contributory factor in triggering the financial crisis.⁵³

In developed countries, support to loss-making companies is less pervasive, but can sometimes take place to a significant extent when governments come to the rescue of “national champions”. For instance, the United States’ antitrust agencies’ contribution to the 2009 OECD Competition Committee’s roundtable on financial markets⁵⁴ cites the government’s provision of loan guarantees to Chrysler Corporation in 1980 as another example of a failed effort which may have had adverse competition consequences. According to the U.S. paper, should Chrysler have failed, the assets could have devolved to a more efficient competitor, and the industry’s competition position could have improved.⁵⁵ Similarly, according to the U.S. Federal Trade Commissioner William Kovacic, the provision of financial assistance to the distressed aircraft manufacturer Lockheed in the early 1970s generated large productive inefficiencies. Had Lockheed been allowed to fail, its assets would have gone to a then more efficient carrier, McDonnell Douglas, the MD10 producer. Today’s landscape could have been very different, according to Commissioner Kovacic, with at least three effective major manufacturers of long-range commercial aircraft: Boeing, Airbus, and McDonnell Douglas.⁵⁶

⁵¹ See for example H. Wang and Y. Jin, 2002, Industrial Ownership and Environmental Performance: Evidence from China, Discussion Paper 2936, World Bank Policy Research Working Paper; S. Pargal and D. Wheeler, 1996, Informal Regulation of Industrial Pollution in Developing Countries: Evidence from Indonesia, *Journal of Political Economy*, vol. 104, 1314–1327.

⁵² S. Gupta and S. Saksena, 2002, Enforcement of Pollution Control Laws and Firm Level Compliance: A Study of Punjab, India, paper presented at 2nd World Congress of Environmental and Resource Economics, Monterey CA; H. Wang, N. Mamingi, B. Laplante, and S. Dasgupta, 2002, Incomplete Enforcement of Pollution Regulation: Bargaining Power of Chinese Factories, World Bank working paper.

⁵³ D. Cho, Banks ‘Too Big to Fail’ Have Grown Even Bigger, *Washington Post*, August 28, 2009.

⁵⁴ Competition and Financial Markets, OECD 2009 : <http://www.oecd.org/dataoecd/45/16/43046091.pdf>

⁵⁵ Note by the United States, OECD Competition Committee Roundtable: Competition and Financial Markets, DAF/COMP(2009)11ADD1, at 225-29, available at <http://www.oecd.org/dataoecd/45/16/43046091.pdf>. The paper also cites federal aid to Penn Central as another example of failed state aid (at 228, fn 10).

⁵⁶ W. Kovacic, participant in Industrial Policy and Competition Law and Policy Roundtable (“Industrial Policy Roundtable”), 2006 Fordham Comp. L. Inst. 239-40 (B. Hawk ed. 2007).

2.5 *Another cost of subsidies: the soft budget constraint and the cost of rent-seeking*

State aids can also have adverse effects on economic efficiency through two more mechanisms. The first one is the so-called “soft budget constraint”. The striking characteristic of this mechanism is that the source of the inefficiency is not the granting of subsidies itself, but rather the expectation that failing firms could be bailed out and subsidised. If it is expected that failing firms will be rescued by governments with some probability, companies may be encouraged to undertake overly risky investments, or to adopt lax management practices. More generally, a firm’s incentives to become more efficient so as to cut costs, raise quality or innovate are likely to be dampened if it expects that the resulting competitive advantage will be offset by the granting of aid to its lazier rivals. This idea has been formulated by the economist Janos Kornai when analysing attempts by the Hungarian government to partly liberalise the economy: *“Although state-owned enterprises were vested with a moral and financial interest in maximising their profits, the chronic loss-makers among them were not allowed to fail. They were always bailed out with financial subsidies or other instruments. Firms could count on surviving even after chronic losses, and this expectation left its mark on their behaviour”*.⁵⁷

This type of mechanism is difficult to measure, because it does not involve a direct causal link between a specific aid and a measurable inefficiency. However, a recent study of the performance of Korean SOEs lends support to the view that the soft budget constraint, i.e., the expectation of bailout by the government in case of failure, has a strong impact on companies’ operating efficiency. This study⁵⁸ finds that Korean SOEs increased their operating efficiency and their profitability between 1998 and 2002, at a time when they were facing the prospect of privatisation because of a commitment by the government in that direction. Hence, the source of the increased efficiency was not privatisation (which in fact did not take place for most of the companies considered), but simply the removal of the expectation that they would be bailed out in case of failure.

The recent debate about Air India’s bailout provides another illustration of this mechanism of soft budget constraint. The government indicated that this was the “first and last time” that it would bail out the airline. As in any such situation, making this commitment credible was an important part of the overall strategy meant to force managers to make tough but necessary decisions, including staff reductions. However, outside observers considered this commitment not to be credible, inter alia, because Air India, like most national carriers, was “too big to fail”, because of its symbolic weight and, last but not least, because it was an SOE.”⁵⁹ Similar stories can be found in many countries, including in Europe.

In some sense, the financial crisis of 2008 is an extreme instance of the damage wrought by the existence of a soft budget constraint. One ingredient that contributed to excessive risk-taking by banks was the implicit government guarantee they felt to be enjoying (and that they indeed were enjoying, as has been revealed by the various, costly rescue plans). Here again, the damage caused by the excessive risk-taking was not caused by the granting of aid, but by the expectation that aid would be granted should the need arise. This remark should not be construed as meaning that the bank rescue schemes were inappropriate; even though there is scope for disagreement on their details; few economists deny the need for some kind of government rescue. However, this observation highlights the possibly major economic costs implied by the expectation of government aid.

⁵⁷ J. Kornai, E. Maskin and G. Roland, 2003, Understanding the Soft Budget Constraint, *Journal of Economic Literature*, vol. 41 (4), p. 1095. See also J. Kornai, 1986, The Soft Budget Constraint, *Kyklos*, vol. 39 (1), p. 3.

⁵⁸ J. Kim and H. Chung, 2008, Empirical Study on the Performance of State-owned –enterprises and the Privatizing Pressure : The Case of Korea, paper presented at the Utrecht conference on “(Re)Regulation in the Wake of Neoliberalism. Consequences of Three Decades of Privatization and Market Liberalization”, available at <http://regulation.upf.edu/utrecht-08-papers/jkim.pdf>.

All these effects share the striking characteristics that the harm is not caused by the subsidies themselves, but rather by the expectation that subsidies might be granted in the future. Such effects cannot, therefore, be accounted for on a case-by-case basis, when evaluating the merits and the costs of a given subsidy.

2.6 *The political mechanisms behind inefficient subsidies*

The above list of mechanisms which can lead to inefficient subsidies being granted fall into two broad categories: negative externalities across jurisdictions and an intrinsic propension of governments to make inefficient decisions. While wasteful subsidy races and the competition for rents in oligopolistic markets, leading to a global excess of production capacities, can be explained by the presence of negative externalities between rational, welfare-maximising (local, regional or national) governments, many other mechanisms are at play that explain why governments tend to grant subsidies that make little economic sense, even from their own narrow point of view.

One can find many examples of subsidies that obviously did not make sense from a collective interest viewpoint and can be better explained by rent-seeking or political motives - an extreme example is aid granted in the 1990s by the State of Michigan to various firms on job-creation grounds at a cost more than 2 million dollars per job.⁶⁰ More generally, the ability of private interest groups to sway economic policy in their favour at the cost of others has been amply documented,⁶¹ just as the impact of firms' political connections on business outcomes, both in developed and developing countries.⁶² For example, according to existing literature, the degree of tariff protection enjoyed by various industries in the United States is directly correlated to the level of donations to political parties.⁶³ There is also evidence that sector- or firm-specific public policy (for instance trade policy) is in general tilted in favour of declining industries. This is a quite general pattern. It can be observed both in US trade policy⁶⁴, and in European state aid policy: for instance, many European governments spent billions of euros trying to keep inefficient coal mines afloat, only to delay their closure by a few years.

A recent econometric study of state aid in Europe⁶⁵ finds that the more a country's political system makes the provision of targeted aid politically profitable (e.g., in countries with small electoral constituencies, little ideological distance between parties, and little party unity), the greater the share of aid to firms that is indeed targeted ("sectoral", in EU parlance), as opposed to "horizontal". This suggests that the provision of support to specific sectors may be based, to some extent, on electoral considerations – despite strict control by the European Commission.

⁶⁰ See R. Tannenwald, 2002, Are State and Local Revenue Systems becoming Obsolete?, *National Tax Journal*, vol. 55 (2), September, p. 467.

⁶¹ T. Persson and G. Tabellini, 2000, *Political Economics: Explaining Economic Policy*, MIT Press.

⁶² B. Roberts, 1990, A Dead Senator Tells No Lies: Seniority and the Distribution of Federal Benefits, *American Journal of Political Science*, vol. 34 (1), 31–58 ; R. Fisman, 2001, Estimating the Value of Political Connections, *American Economic Review*.

⁶³ P. Goldberg and G. Maggi, 1999, Protection for Sale: An Empirical Investigation, *American Economic Review*, vol. 89 (5), p. 1135.

⁶⁴ G. Hufbauer and H. Rosen, 1986, Trade Policy for Troubled Industries, Policy Analyses in International Economics 15, Institute for International Economics Washington, D.C.; G. Hufbauer, Gary, D. Berliner and K. Elliot, 1986, Trade Protection in the United States: 31 Case Studies, Institute for International Economics, Washington, D.C. ; E. Ray, 1991, Protection of manufactures in the US, in D. Green, *Global Protectionism: Is the US playing on a level field?* Macmillan, London.

⁶⁵ U. Aydin, 2007, Politics of state aid in the European Union: Subsidies as Distributive Politics, University of Washington, Political Science Department, unpublished.

These findings have two consequences. First, rent-seeking and politically motivated decisions may affect the nature and destination of subsidies, often leading to an inefficient use of public funds and to productive and allocative inefficiencies. In addition, the more subsidy granting lends itself to capture by private interests, the more companies are likely to invest in rent-seeking activities, which represents a waste of resources: according to various estimates, the cost of rent-seeking activities is very high.⁶⁶

The handling of the recent financial crisis is a case in point. Some observers argue that the U.S. bailout scheme was tilted in favour of banks' shareholders rather than to a potentially more efficient scheme, which would have involved the nationalisation of some insolvent banks.⁶⁷ Similarly, an analysis of US congressmen's voting patterns regarding the Emergency Economic Stabilisation Act ("EESA") in October 2008, which according to the authors of the study "transfers wealth from tax payers to the financial services industry" reveals that "higher campaign contributions from the financial services industry are associated with an increased likelihood of voting in favour of the EESA".⁶⁸

Subsidies sometimes create new vested interests that engage in rent-seeking, for instance by pursuing the perpetuation of industrial policies which should in fact be interrupted because of changing circumstances. The Concorde project, sponsored by the British and French governments, illustrates this point.⁶⁹ The launch of a supersonic plane made sense in the cheap oil world of the 1960s, but the project lost its economic rationale after the oil shock of 1973. However, its advanced stage implied that the large group of civil servants and businessmen with a stake in the Concorde project had a strong interest in the continuation of the project. Ultimately, this group prevailed over market signals and the project went ahead, at a considerable cost to both governments.

This type of harmful causal chain occurs in a variety of situations. In contrast to the high-technology example of the Concorde project, the policy followed by many Indian states that subsidised electric power for farmers in order to foster water pumping and irrigation created a similar lock-in effect. Faced with cheap power, many farmers acquired pumps and invested know-how in the growing of thirsty crops. This financial and human investment reinforced the demand for cheap power: basically, the idea is that subsidising a good (in this case, electric power) creates an incentive for the recipient of the subsidy to invest in a complementary good (in this case, electric pumps and the know-how regarding the growing of thirsty crops), which increases the demand for the original subsidy. In the end, the political pressure for the continuation of subsidies to electric power became the main driver of the continuation of this policy, long after politicians had realised how harmful it was.

⁶⁶ In the United States, total expenditures on transfer activity have been estimated at 25% of GDP (D. Laband and J. Sophocleus, 1992, An Estimate of Expenditures on Transfer Activity in the United States, *Quarterly Journal of Economics*, vol. 107(3), 959-983). Other estimates, based on regressions of gross national output on the relative number of lawyers (supposed to be a proxy for the magnitude of rent-seeking activities) and physicians or engineers (supposed to be a proxy for the magnitude of productive activity) point to similar or even higher costs of rent-seeking (S. Magee, W. Brock and L. Young, 1989, *Black Hole Tariffs and Endogenous Policy Theory: Political Economy in General Equilibrium*, Cambridge University Press; K. Murphy, A. Shleifer and R. Vishny, 1991, The Allocation of Talent: Implications for Growth, *Quarterly Journal of Economics*, vol. 106(2), 503-530.)

⁶⁷ M. Richardson and N. Roubini, Nationalize the Banks! We're all Swedes Now, *Washington Post*, February 15, 2009.

⁶⁸ A. Mian, A. Sufi and F. Trebbi, 2009, The Political Economy of the U.S. Mortgage Default Crisis, NBER Working Paper # 14468.

⁶⁹ D. Myddleton, 2007, *They Meant Well: Government Project Disasters*, Institute of Economic Affairs Monographs, Hobart Paper No. 160.

The large subsidies to agriculture in many countries are another case in point. For instance, the common agricultural policy put in place by the European Union were initially justified on efficiency grounds, on at least two counts. First, it was meant to encourage European farmers to adopt more efficient technologies, which involved in some cases very difficult adjustments, such as exchanges of parcels of land between farmers so as to end up with farm shapes that lent themselves to modern techniques. Second, it was meant to bring Europe towards food self-sufficiency, which in the 1960s would have been a worthy goal, as in the context of the cold war the notion of “food security” made sense. However, by the 1990s these justifications had all but disappeared. One could have imagined that it would be easy to decrease the amount of subsidies to agriculture, but that did not happen because the beneficiaries of the subsidies had become a powerful political constituency. Similarly, subsidies to increase ethanol production in the United States, initially intended to develop an alternative to fossil fuels, turned out to be economically unsound when in 2007 and 2008 the price of corn and sugar cane (used to produce ethanol) started to rise. However, there was strong pressure to maintain the status-*quo*, in particular because the ethanol subsidies had been capitalised in land prices, which made a policy turnaround difficult.

A recent study of the investment decisions made by sovereign wealth funds confirms that the more politicians are involved, the more they tend to use these funds as vehicles for the subsidisation of domestic companies.⁷⁰ This study finds that sovereign wealth funds where politicians have a greater involvement in management tend to invest more in domestic companies (which is consistent with the view that they use such funds to reward friends rather than to diversify their countries’ assets) and that they tend to invest in companies with higher price/earnings ratios, which have on average a negative valuation change after the investment. This last finding suggests that sovereign wealth funds where politicians have a greater involvement tend to subsidise the firms in which they invest, by supplying them with capital on terms that are below those that would have led to normal rates of return.

The recent spate of bailouts of troubled firms, in the wake of the financial crisis, illustrates the tendency for governments’ funds to be handed out on the basis of somewhat-unclear economic criteria. For instance, in Russia, Vneshekonombnak (VEB), the state development bank, announced in 2009 plans to lend about \$ 50 billion to distressed companies, with the possibility to convert loans into government shares should the beneficiaries be unable to repay. However, many observers, including in Russia, criticised the lack of objective criteria governing either the choice of the beneficiaries, or the nature of the assistance (and in particular the absence of any conditions attached to the granting of aid), to the point that some observers claimed that “a \$50 Billion Bailout in Russia Favours the Rich and Connected”⁷¹. For instance, the carmaker Avtovaz received in 2009 a \$ 730 million interest-free loan, a \$ 230 million loan from state banks at a favourable rate, and a commitment by state-owned banks to help it raise an additional \$ 2.6 billion from banks. In exchange, no commitment was demanded in terms of management, in spite of the broadly held view that Avtovaz is far from the efficiency frontier in the automotive industry. As a result, the Russian Union of Industrialists and Entrepreneurs called for the creation of transparent, public standards for financial aid distribution and warning about the dangers of favouritism. The financial advisor who originated this bailout strategy even criticised the “frittering away of funds, directing them toward inefficient companies with political connections”.⁷²

⁷⁰ S. Bernstein, J. Lerner, A. Schoar, 2009, *The Investment Strategies of Sovereign Wealth Funds*, Harvard Business School Working Paper 09-112.

⁷¹ *New York Times*, 31 October 2008.

⁷² A. Kramer, *Russian Auto Bailout Protects Jobs, Not Efficiency*, April 7, 2009 ; the ISCIP Analyst, *An Analytical Review*, vol. XV (4), 6 November 2008 ; P. Pan, *Russian élite look to Kremlin for aid as wealth evaporates*, *Washington Post*, 17 October 2008.

Another mechanism leading to inefficient subsidies is at play in the case of countries where a large share of government revenues comes from the export of raw materials, such as oil. Public knowledge of the windfall revenues that fall into government coffers in times of high world prices create a popular pressure for redistribution, and governments often feel that the least risky way for them to redistribute part of the windfall revenues is by subsidising the raw material that generated the windfall in the first place. This is because such a redistribution entails an automatic “fiscal stabiliser”, since its cost is directly proportional to the windfall revenues. However, this redistribution mechanism is highly inefficient because it distorts price signals, as explained above. A possible solution is the creation of offshore funds allowing governments to tie their own hands, such as those created by Norway, Kuwait or Azerbaijan.

According to Rodrik (1995)⁷³, the subsidisation of nascent industries in East Asian countries in the last decades was relatively immune to rent-seeking, unlike the situation observed in most developing and many developed countries. As Rodrik (2004)⁷⁴ points out, the presence of rent-seeking does not by itself suffice to conclude against targeted subsidies and industrial policy, no more than rent-seeking in education justifies an end to the public provision of education. However, these findings plead against policies that endow governments with tools allowing them to arbitrarily favour specific firms. More across-the-board instruments, or aid targeted to new firms and new activities, on a temporary basis, would probably limit the scope for rent-seeking.

There exist good reasons for governments to grant subsidies to companies in specific circumstances. These reasons (often, but not exclusively falling into the category of “industrial policy”) do not, however, justify signing a blank cheque for subsidies. As the above examples show, political dynamics may imply that a subsidy that is initially sound from an economic viewpoint creates vested interests that make its removal very difficult even after it has lost its initial justification. Also, as is explained hereafter, the existence of theoretical justifications for subsidies in some cases does not imply that governments, even benevolent ones immune from the pressure of special interests, can easily identify which subsidies are “right” and which would be wasteful.

3. The possible justifications for state aids and their limits

3.1 A quick overview of the most frequent justifications for state aids and subsidies

The most frequent justification for state aids and subsidies is that they allow governments to correct market failures of various kinds.

For instance, markets may fail to deliver a distribution of income that is considered to be fair or politically desirable. In principle, the proper tool to address this type of market failure is not the granting of subsidies, but rather fiscal policy. However, in some circumstances, especially when governments’ goal is to provide income support to a category of the population that is defined by its economic activity (for instance, agriculture), rather than by its monetary income, they choose to subsidise an economic activity directly.

Another frequent justification for the granting of subsidies to private companies is the goal of saving jobs, when a company faces the prospect of bankruptcy, or the “threat” of foreign takeover sometimes deemed to threaten jobs.

⁷³ D. Rodrik, 1995, Getting Interventions Right: How South Korea and Taiwan Grew Rich, *Economic Policy*, vol. 10(20).

⁷⁴ D. Rodrik, 2004, Industrial Policy for the twenty-first century, Harvard Kennedy School Working Paper 04-047.

However, the most frequent justification for state aids and subsidies is the presence of positive externalities generated by some activities, i.e., the idea that the social value of some activities exceeds their private value. Unless the gap between the social and private value is filled by subsidies, private agents have an insufficient incentive to engage into a socially valuable activity. This idea is at the root of the subsidies that are part of “industrial policy”.

The various mechanisms possibly justifying the granting of subsidies are reviewed hereafter. We also highlight the limits and the risks associated with the granting of subsidies even when objective justifications seem to exist; and we illustrate hereafter how the new economic approach implemented by the European Commission assesses the various possible justifications for state aids.

3.2 *Subsidies as income support*

The most natural instrument to redistribute income is taxation and transfers to individuals. However, in some cases, interest-group politics push governments to redistribute income not on the basis of monetary criteria, but on other grounds, such as supporting the members of certain professions. An obvious example is agriculture. For instance, the average income transferred to an average individual farmer in France, through the common agricultural policy, was €17,000 in 1999,⁷⁵ even though farmers are not, on average, poorer than the average population.

Subsidies are in general an inefficient way to redistribute income because they generate price distortions. For instance, the welfare loss induced by the common agricultural policy before its reform (which started in 2004) has been estimated at 0.9% of European GDP, which is a lot given that agriculture accounts only for 2% of European GDP.⁷⁶

This example highlights that subsidies are not an efficient way to redistribute income. It creates vested interests that make the removal or even the mere adaptation of subsidies difficult, and creates significant economic costs.

Another weakness of the use of subsidies as a redistributive tool, rather than direct income taxation and redistribution, is that subsidies often miss their goals because they may end up being appropriated by agents that are not the intended beneficiaries. Again, aid to agriculture is a case in point. The factor in agriculture is land, whose supply is inelastic, rather than labour. As a consequence, economic theory predicts that subsidies are most likely to be reflected in the price of agricultural land, rather than in the income of agricultural labourers. This reasoning has been confirmed by experience: from 1983 on, New Zealand drastically reduced its subsidies to agriculture, dividing them by 10. As a result, the income of agricultural labourers fell sharply in the first two years. However, this fall was followed by a large rebound, as the price of land fell, and the income of agricultural labourers' soon recovered and finally reached its initial level. This highlights the fact that subsidies are an awkward redistributive instrument.⁷⁷

In order to tackle this difficulty, many countries, including the members of the European Union and the United States decided to reform agricultural policy by shifting from the subsidisation of production to direct income support, in the form of lump-sum transfers, the amount of which is determined on the basis of “historical” rights, depending on the amount of subsidies received in the past under the previous, price-

⁷⁵ P. Messerlin, 2004, Forging a deal on Agricultural Trade Reform, communication at the conference entitled “Breaking the Deadlock in Agricultural Trade and Development”, Oxford, June 2004.

⁷⁶ B. Borrell and L. Hubbard, 2000, Global Economic Effects of the EU Common Agricultural Policy, *Economic Affairs: Reforming the CAP*, N° 20.

⁷⁷ Gilles Saint-Paul, 2007, Commentaire, in P. Chalmin and D. Bureau, Perspectives agricoles en France et en Europe, Conseil d'Analyse Economique.

distorting system. This type of subsidy seems to be less inefficient in that it is supposed not to alter production decisions. This is why the WTO (then GATT) agreements tend to view such subsidies favourably (meaning, technically, that they are classified as “green box” subsidies). However, in practice, even such subsidies appear to be somewhat distortive, because they may lack credibility. Agents tend to believe that since past activity gives a right to a lump-sum transfer today, then present activity might entitle them to some transfer in the future. Existing studies of the evolution of agricultural policies around the world therefore tend to caution against the view that lump-sum transfers are a panacea. While they are less distortive than direct production subsidies, they may still be distortive.⁷⁸

3.3 *Subsidies as a way to palliate credit and financial market imperfections*

Credit market imperfections in many cases create a wedge between the social and the private value of economic activities. The reason is that firms that could engage in productive activities may be prevented from doing so because of insufficient access to credit, due to informational asymmetries between lenders and borrowers. Credit rationing has become particularly acute lately as a consequence of the financial crisis. The simple claim that governments know no better than banks which firms deserve credit, and that subsidising credit makes therefore little sense. As standard economic theory has shown, the private supply of credit may be suboptimal in the presence of asymmetric information, which may in principle justify the subsidisation of credit even if governments are no better informed than private lenders.

Directly or indirectly subsidised credit is prevalent in many countries, especially in developing ones. For instance, Indian law requires banks to direct at least 40% of their credit to “priority sectors”, which include agriculture, agricultural processing and “small scale industry”. Another important instance of subsidised credit is the case of microfinance institutions in developing countries, which provide small loans, often backed by subsidies from governments or aid organisations.

One difficulty in ascertaining the relevance of subsidies as a tool to palliate credit rationing is the risk that publicly subsidised lending will simply crowd out private lending rather than expand the total volume of lending and increase production, resulting in a purely distributional effect.

While the situations are undoubtedly diverse, there is some evidence that subsidised lending in developing countries has an impact on economic activity and on small firms’ ability to invest. A recent study of the abovementioned directed lending programme in India finds that subsidised credit is not used as a substitute for private credit, but rather as a complement. It has indeed been found that when changes in rules increased some firms’ eligibility to the program, their total borrowing and their total production increased. While this study does not present an overall cost-benefit analysis, it shows that the subsidy at least meets its purported goal of expanding the production opportunities of small firms.⁷⁹

Similarly, a study of microfinance institutions in South Africa found that rate subsidisation had an impact on takeup rates by the targeted populations, i.e., poor populations in developing countries.⁸⁰

⁷⁸ A. Bouet, J.C. Bureau, Y. Decreux, and S. Jean, 2004, Multilateral Trade Liberalisation: The Contrasting Fortunes of Developing Countries in the Doha Round, Discussion Paper No. 60, Institute of International Integration Studies, Trinity College, Dublin ; E. O’Donoghue and J. Whitaker, 2006, How distortive are direct payments?, paper presented at the 2006 American Agricultural Economics Association conference.

⁷⁹ A. Banerjee and E. Duflo, 2002, Do Firms Want to Borrow More? Testing Credit Constraints Using a Directed Lending Program, MIT Department of Economics Working Paper No. 02-25.

⁸⁰ D.S. Karlan and J. Zinman, 2008, Credit Elasticities in Less-Developed Economies: Implications for Microfinance, *American Economic Review*, vol. 98(3), 1040–68.

Credit rationing is not the only type of financial market imperfection. More generally, financial markets may be unable to provide instruments allowing companies to reallocate risk optimally. Nuclear energy is a good illustration of the wedge between the social and the private value of some investments. For countries deprived of fossil fuel resources, nuclear energy is a way to reduce the exposure to the fluctuations of fossil fuel prices. However, from the viewpoint of private companies, the fact that the cost of nuclear-generated electricity is insensitive to fossil fuel prices is a risk, because electricity prices are mostly determined by fossil fuel prices (since they are determined at every instant by the marginal cost of the marginal means of production, which is almost always a fossil-fuel burning plant, even in countries with large nuclear generation capacities). Therefore, the return on an investment in a nuclear plant is sensitive to the fluctuations of fossil fuel prices, unlike the returns on an investment in a fossil-fuel fired plant. If financial markets were perfect, firms engaging in nuclear investments could issue bonds that would be indexed on fossil-fuel prices and hence shift the risk to the market. However, such refined financial instruments barely exist, and the wedge between the social value of limiting the exposure to the volatility of fossil-fuel prices and private incentives cannot be bridged by market mechanisms alone. This reasoning explains in part why the U.S. government decided to subsidise investment in nuclear generation in its Energy Policy Act (2005), providing tax credits and insurance against construction delays.

3.4 *Subsidies as a way to account for discovery and agglomeration externalities*

The concentration of firms active in the same sector, in a given region, is often considered to generate local positive externalities. Three types of mechanisms can be distinguished, on the basis of the existing empirical studies. The first is input sharing: the concentration of firms in the same sector in a given area attracts input suppliers, which lowers all firms' costs. The second is labour market pooling: a concentration of firms attracts a large pool of workers with the requisite sector-specific skills, leading to reduced search costs for both workers and firms. The third is knowledge spillovers: a company's R&D efforts may benefit other companies because new knowledge diffuses outside the company undertaking R&D, through social and business interaction (for instance between suppliers and customers), or as a consequence of employees moving across companies. A variant of these arguments, especially relevant to developing economies, involves informational externalities: whenever a firm is established in a new sector, other agents observe its performance and learn about the prospects in that sector. According to Rodrik (2004)⁸¹, this discovery process generates positive information externalities and therefore warrants government intervention aiming to identify promising sectors and to encourage firms to enter them.

The empirical evidence is twofold. On the one hand, there is a lot of evidence that positive agglomeration externalities exist, thereby making the theoretical claim for industrial policy reasonable. On the other hand, the evidence on governments' attempts to emulate the Silicon Valley or to jump start activity in a new sector is mixed. Many such attempts failed, and several success stories appear to owe little to governments. However, in some instances, especially in developing countries, government intervention played a key role in the successful development of entirely new sector, as is explained below.

The importance of agglomeration effects and sector-wide economies of scale has been substantiated by a series of convergent studies. Their magnitude is likely to be quite large: for instance, according to a recent study, a doubling in the regional scale of an industry leads on average, in Japan, to a 4.5% increase in productivity⁸². As opposed to intra-firm economies of scale, such intrasectoral economies of scale in theory justify public intervention in order to help industries reach a large enough scale. The various underlying mechanisms have been measured as well. The input sharing assumption has received empirical

⁸¹ D. Rodrik, 2004, *Industrial Policy for the twenty-first century*, Harvard Kennedy School Working Paper 04-047.

⁸² R. Nakamura, 2005, *Agglomeration economies in urban manufacturing industries: a case of Japanese cities*, *Journal of Urban Economics*, vol.17, 108-124.

confirmation: the more firms are concentrated in an area, the more outsourcing one observes, which reflects the greater availability of outside inputs.⁸³ The best-documented type of local externality is knowledge spillovers. For instance, Agrawal et al (2006) showed, by studying patent citations, that the knowledge created by an inventor is applied disproportionately in locations where the inventor lived previously, which can be explained only by the importance of personal connections⁸⁴, and Audrestch and Feldman (1996) highlighted the geographic concentration of innovations.⁸⁵

There is evidence that many developing countries' specialisations owes more to the development of sectors in which there was an initial presence, because of agglomeration and informational externalities, than to genuine comparative advantage. For instance, as Hausman and Rodrik (2003)⁸⁶ note, countries with nearly identical resource endowments end up with very different specialisations: Korea exports microwave ovens but no bicycles, while Taiwan exports bicycles but almost no microwave ovens; Bangladesh is one of the main exporters of hats worldwide while Pakistan exports almost none. These findings suggest that specialisation patterns are largely explained by random events occurring at the initial stage of development, i.e., on random attempts by lone entrepreneurs, which then give rise to self-reinforcing dynamics. If that is the case, then there would be a case for the temporary subsidisation of new sectors by the government.

Interestingly, there is some evidence pointing towards the fact that positive local spillovers (adjusting for firm size) are less important when a large firm settles in a region than when a small firm does.⁸⁷ This is probably because large firms have less need for interaction with outsiders. However, there also is some anecdotal evidence in the other direction, pointing to the importance of large firms in the success of some innovative clusters (like Nokia in Finland).⁸⁸

In contrast to the accumulation of knowledge about the nature and magnitude of agglomeration externalities, the evaluation of the public policies supposed to stimulate them yields mixed results. Many governments' attempts to emulate the Silicon Valley have proved inconclusive, even in the United States where first-hand, detailed information was available. A comprehensive study of innovative clusters by the OECD highlights the diversity of the mechanisms that allowed some clusters to flourish and concludes that (i) it is very difficult to measure the contribution of public policy to the success of some of these clusters, and (ii) there is no single, one-size-fits-all policy prescription. Tellingly, one of the most successful technological clusters in the developing world, in the Bangalore region, appears to have been caused by a series of serendipitous events (such as IBM's refusal to let Indian shareholders purchase 60% of its Indian

⁸³ T.J. Holmes, 1999, Localization of Industry and Vertical Disintegration, *Review of Economics and Statistics*, vol. 81(2), 314-25.

⁸⁴ A. Agrawal, I. Cockburn and J. McHale, 2006, Gone But Not Forgotten: Knowledge Flows, Labor Mobility, and Enduring Social Relationships, *Journal of Economic Geography*, vol. 6(5); see also E. Moretti, 2004, Workers' Education, Spillovers and Productivity: Evidence from Plant-Level Production Functions, *American Economic Review*, vol. 94(3).

⁸⁵ D.B. Audrestch and M. Feldman, 1996, R&D Spillovers and the geography of innovation and production, *American Economic Review*, vol. 86, 630-664.

⁸⁶ R. Hausman and D. Rodrik, 2003, Economic Development as Self-Discovery, *Journal of Development Economics*, vol. 72.

⁸⁷ Rosenthal, S. S. and W. C. Strange, 2003, Geography, Industrial Organization, and Agglomeration, *Review of Economics and Statistics*, vol. 85 (2), 377-393.

⁸⁸ See the chapter on Finland in OECD, Innovative Clusters, 2001.

subsidiary, which led IBM to leave India and forced Indian software professionals to turn towards open platforms, thereby acquiring the skills that would prove highly valuable more than ten years later).⁸⁹

Conversely, Rodrik (2004)⁹⁰ argues that some industrial policies followed in Latin America and East Asia succeeded in taking into account informational externalities and fostering the development of entirely new sectors. For instance, in Chile, the public agency Fundacion Chile started to subsidise salmon farming in the 1970s. Whereas this industry was inexistent in Chile prior to this policy, Chile is now one of the main exporters of salmon. Similarly, Rodrik argues that the launch of orchid production by government firms in Taiwan, that is, with government funds, was a good way to reveal the profitability of this sector in order to stimulate private investment and the development of a new sector. According to Rodrik (1995), the case of the Korean conglomerate Hyundai is a stunning illustration of the usefulness of a properly implemented policy targeting a national champion. On the one hand, government support to diversification allowed Hyundai to internalise labour market externalities, as managers who had acquired skills in the cement and construction industry could then apply them to other sectors, as Hyundai developed new activities, such as car manufacturing and shipbuilding. On the other hand, the government's direct and indirect subsidisation (including in the form of implicit purchase guarantees for the ship building division, as explained above) encouraged Hyundai to catch up with foreign incumbents in terms of efficiency.

However, Rodrik stresses the limitation of such policies. Unless subsidies to investors in new sectors are strictly limited in their scope (with a restriction to really new sectors) and duration (long enough for discovery to occur, but not longer) and made conditional on some market-based measure of performance, they may well be inefficient.

The general implication of the empirical literature on agglomeration effects is that while they are important, the appropriate policy tools to deal with them are complex and not yet fully understood. In particular, while some kind of industrial policy is likely to be helpful, there seem to be good reasons to focus them on smaller firms at an early stage of development rather than on existing champions, because the various abovementioned externalities are likely to be more acute in the case of small firms.

In the European Union, the possible use of public funds to foster the development of innovative clusters has been recognised. The FRDI⁹¹ states that *"Aid for innovation clusters aims at tackling market failures linked with coordination problems hampering the development of clusters, or limiting the interaction and knowledge flows within clusters. State aid could contribute in two ways to this problem: first by supporting the investment in open and shared infrastructures for innovation clusters, and secondly by supporting cluster animation, so that collaboration, networking and learning is enhanced."*

The detailed recommendations of the Community Framework highlight the way in which it is possible to tread the fine line between subsidising truly externality-generating activities and wasting public funds. The Commission recognises the positive externalities often generated by clusters and acknowledges that they may justify the granting of subsidies, but it also mentions two safeguards. First, the maximum authorised aid intensity is 15% (with exceptions for some underdeveloped regions or Member States). Second, and more important maybe, aid should be targeted to expenses that directly relate to the externalities, i.e., those that contribute to the functioning of the cluster without their benefits being directly

⁸⁹ H. Pack and K. Saggi, 2006, Is There a Case for Industrial Policy? A Critical Survey, The World Bank Research Observer, vol. 21(2).

⁹⁰ D. Rodrik, 2004, Industrial Policy for the twenty-first century, Harvard Kennedy School Working Paper 04-047.

⁹¹ Community Framework for state aid for Research and Development and Innovation (<http://eur-lex.europa.eu/LexUriServ/LexUriServ.do?uri=OJ:C:2006:323:0001:0026:en:PDF>).

appropriated by specific companies. The expenses include for instance “marketing of the cluster to recruit new companies to take part in the cluster, management of the cluster’s open-access facilities, and the organisation of training programmes, workshops and conferences to support knowledge sharing and networking between the members of the cluster.”

3.5 *Subsidies to research, development and innovation as a way to account for knowledge spillovers*

More generally, research, development and innovation (R&D&I) is often considered to give rise to externalities. As is explained in a recent commentary of the new Framework on Aid to R&D&I published by the European Commission, positive externalities may be present for the following reasons: “R&D&I activities generate new knowledge, which is beneficial to society because it can be used by many companies to invent or improve products and services. However, from the perspective of a single company, only the private benefits from investing in R&D&I are accounted for. As a result, R&D&I activities are sometimes not undertaken by private companies, because they consider the resulting private benefits too limited, whereas the benefits for society, due to the knowledge spillovers of R&D&I, could be important. R&D&I activities generate new knowledge, which cannot always be protected (e.g. through patents). Private companies may thus refrain from investing in R&D&I because they are afraid that the results of their investments may be used by competitors and they consequently cannot generate any profit from their investments. Imperfect and asymmetric information: R&D&I activities are particularly risky and uncertain. This means that they are affected by imperfect and asymmetric information. As a result, too few human and financial resources may be invested in R&D&I projects, which would however be highly valuable for society. Coordination and network failures: R&D&I activities are often unsure and complex and it is not easy for private companies to work together, identify suitable partners and coordinate R&D&I projects. As a result of these coordination and network failures, R&D&I projects that could have been conducted in common between a group of firms are sometimes not undertaken at all, whereas society as a whole would have benefited.”⁹²

All the praise lavished on aid to R&D&I notwithstanding, some caveats must be borne in mind. True, R&D&I combines externalities (due to knowledge spillovers) and informational asymmetries (which may result in underfunding). But these asymmetries also imply that aid to R&D&I may give rise to inefficiencies.

One of the main reasons is that subsidised R&D may crowd out privately funded R&D, since firms may misrepresent the extent to which their R&D investments are sensitive to the granting of aid.⁹³ Some recent European state aid cases illustrate this difficulty. In its *Quaero* decision⁹⁴, the Commission granted subsidies to a joint public-private research program. Its reasoning was based on the following two elements. First, the existence of an externality induced by the private firm’s R&D expenditures, since the results of this effort would be disseminated by its public (academic) partners rather than appropriated privately. Second, in order to assess whether the aid was likely to have an impact on the private firm’s R&D investment, the Commission relied on the beneficiary’s internal estimates of the resources it was planning to devote to the R&D project at stake, according to the level of aid. This type of assessment is probably the best that can be conducted. However, it is strikingly simple when compared to the economic analyses undertaken by competition authorities investigating mergers for instance, and one may wonder

⁹² T. Kleiner and R. Replinger-Hach, 2007, “The new community framework for state aid for research and development and innovation”, *Competition Policy Newsletter*, vol. 1.

⁹³ P. David, B. Hall, and A. Toole, 2000, Is public R&D a complement or substitute for private R&D? A review of the econometric evidence, *Research Policy*, vol. 29(4-5), 497-529.

⁹⁴ Case N° C-243/02, http://ec.europa.eu/community_law/state_aids/comp-2007/n469-07.pdf.

whether it might be easily manipulated by companies lobbying for public funds without a real public interest justification.

3.6 Environmental subsidies

As is explained above, many existing subsidies have harmful effects on the environment, if only because they shift production away from more efficient to less efficient companies, which are often less environment-friendly.

However, many subsidies are also targeted to the development of renewable energies, as part of a global effort to curb carbon dioxide emissions. In the European Union, such “environmental aid” represent a quarter of total aid to industry (about \$ 13 billion in 2008), and the Commission issued in 2008 the Community guidelines on state aid for environmental protection, which allow national governments to engage in a variety of measures, ranging from subsidised credit for all kinds of environment-friendly actions (such as the replacement of a polluting industrial equipment with a cleaner one) to feed-in tariffs, i.e., guaranteed prices at which the government commits to purchase electricity produced from renewable sources, such as wind and solar.

As a result, 18 EU countries were using feed-in tariffs in 2007, and as such tariffs also exist, among others, in Canada, China, Israel, and several Australian states. At first glance, the rationale for such subsidies is obvious, since environment-friendly investments are a pure case of a positive externality. However, the rationality of such subsidies is far from obvious, because the combination of various environmental subsidies often amounts to an incoherent combination, with each mechanism assigning a different price to carbon dioxide emissions. As an example, the current feed-in price for solar energy in France involves an implicit price of about € 1,000 per tonne of carbon dioxide. This amount can be compared to the current price in the European Emissions Trading Scheme, that is below € 20, and to the level of the “carbon tax” envisioned by the French government, i.e., €17.

As the Stern report⁹⁵ highlighted, the least costly way to curb emissions is to provide a uniform price signal (through a tax or a cap-and-trade permit system), inducing all economic agents to make all emissions-reducing decisions whose cost falls below a certain threshold, without deciding arbitrarily how emissions should be reduced. Direct subsidies to specific ways of reducing emissions may in the end increase the cost of the emissions reduction effort, and make this effort less effective. One may, however, qualify this view by arguing that certain renewable technologies, still at an infant stage, deserve specific support, precisely because of the type of informational externality discussed above in the context of aid to new sectors.

4. How should state aids and subsidies be controlled?

4.1 The limits of economic analysis: measurement issues

In an ideal world, the policy prescription would be that benevolent governments should assess each potential subsidy on its specific merits, evaluating whether a positive externality is present, possibly quantifying it, assessing the incentive impact of the aid, and conducting an overall cost-benefit analysis.

However, this type of assessment, that would be based on a neutral presumption and would consider each aid measure on its merits alone is unrealistic, because many of the abovementioned positive and negative consequences of state aids do not lend themselves to measurement.

⁹⁵ N. Stern, 2007, *The Economics of Climate Change: the Stern Review*, Cambridge University Press.

The assessment of the impact of an aid bears some similarities to the assessment of the competitive impact of mergers. In both cases, the goal is to assess how the market will be affected by a given change. However, in the case of state aid, this exercise is far more complex than in the case of mergers.

The assessment of unilateral effects, which lies at the heart of horizontal merger control, provides for a helpful comparison. Its ambition, compared with the scope of the questions raised by the analysis of state aid control, is relatively narrow: it limits itself to short-run effects, and takes market structure as given (except for the merging parties, of course). It lends itself to the econometric technique of merger simulation, which yields quantitative predictions based on parsimonious data requests. Yet, even within this well-delineated framework, merger control is far from being completely predictable, especially as regards the assessment of efficiencies.⁹⁶

The questions which need to be addressed in order to assess a state aid measure are both more numerous, and often less liable to quantification than unilateral effects.

Consider for example aid to R&D. One of the main justifications for the granting of aid to R&D is the existence of a positive externality due to knowledge spillovers. But how can the likelihood of such spillovers be proved in an individual case? The empirical research on this topic almost never proceeded by identifying the presence of spillovers in individual cases; but rather by studying large datasets and identifying the existence of knowledge spillovers on average, using sophisticated statistical techniques. Besides, even this approach fails to end up on firm ground, since the findings of the various studies are significantly divergent. In the case of mergers, the study of past mergers in the same market can often be considered to have some predictive value. But in the case of R&D, such an approach is less promising, because of the difficulty of finding relevant precedents, especially when the goal is to assess an innovation which has not yet occurred and the nature of which is uncertain by definition. This difficulty is reminiscent of the one faced by firms making efficiency claims when defending a merger. Such claims are often rejected for want of verifiability up to competition authorities' high standards. But the problem may be even more acute for state aid control, since the innovations purportedly encouraged are more radical, and thus more uncertain and less verifiable, than the incremental improvements representing the majority of efficiency claims in merger control. If and when spillovers can be shown to be likely, one should also ascertain whether the amount of R&D is sensitive to the volume of aid. Answering this question requires one to know not only the cost of funds available to the firm and the possible credit constraints facing it, but also the list of alternative possible investments for the recipient of the aid, the impact of the R&D effort on the firm's future production costs, as well as an estimate of market demand and rivals' marginal costs, so as to calculate how a given cost reduction, if achieved thanks to R&D, will affect profits. In many cases, the question is even more complex because R&D often aims to create new products rather than to decrease the cost of producing existing ones. Therefore, in order to calculate whether the firm's behaviour is likely to be impacted by the aid, one needs to make assumptions about the demand function in the hypothetical post-R&D world, i.e., for example, about the elasticity of substitution between rivals' goods and the hypothetical, not yet existing new good which the subsidised R&D might – or might not – bring into existence.

This difficulty is by no means limited to R&D, as can be seen by moving to the question of dynamic inefficiencies - which is often, and probably rightly, mentioned as a justification for state aid control. There is no simple way of quantifying with full certainty to what extent the granting of an aid will change economic agents' expectations in the long-run, and thus their investment and innovation behaviour. Answering this question would require one to assess the impact of any given aid on other firms' expectations as to the likelihood of being granted state aid in the future under different types of

⁹⁶ D. Gifford et R. Kudrle, 2005, Rhetoric and Reality in the Merger Standards of the United States, Canada and the European Union, *Antitrust LawJournal*, vol. 72, p. 423.

circumstances, and to measure the impact on this change in expectations on firms' future behaviour (excessive risk-taking or "X-inefficiency" resulting from the reinforced soft budget constraint, diversion of resources from productive to rent-seeking activity, etc.)

Finally, any quantitative assessment of the welfare impact of a state aid must start by making an assumption about the cost of public funds, because, when calculating the overall impact of an aid on welfare, the loss to taxpayers is usually a major element. In fact, in all simple models of distortive state aid, as well as in simple models of subsidy races, there is no harm at all unless this deadweight cost of taxation is large enough.

These observations appear to indicate that a presumption that state aids are neutral for competition may not be justified. Since the available evidence points towards a negative impact of most subsidies, this should support the idea that it is up to the government granting the aid to demonstrate that the benefits of such a measure outweigh its negative effects on competition. Such an approach would signal the concerns with a systematic policy of granting state aids, leaving however room for the necessary flexibility through a case-by-case assessment.

While the recourse to economic analysis should not be seen as a panacea justifying a neutral a priori presumption, it can still be very helpful in order to assess whether a given aid measure is likely to be beneficial to social welfare. In particular, economic analysis can play a crucial role in identifying the presence of market failures and whether a proposed subsidy is likely to remedy it without creating serious offsetting distortions.

4.2 Meeting the goal of "less and better targeted state aids"

The above developments point, overall, to the dangers of state aids and subsidies. On the one hand, even benevolent governments, local, regional or national, may rationally engage into destructive subsidy races, at an enormous cost to public funds. On the other hand, it is very difficult for state aids to escape the pressure from special interests, and they also contribute to creating special interest groups with then push for the continuation of the granting of aid even after it has lost its initial justification. Even in the European Union, where control is strict, there is evidence that aid often lacks proper justification and does not make for a very efficient use of public funds.

Since one should not be overly confident in the ability of any government or specialised agency to evaluate each possible subsidy on its merits, it makes sense to consider that countries should enact rules that make the granting of subsidies difficult on a general basis, while leaving some margin of flexibility (since aid is sometimes justified).

Currently, many countries have no strict state aid control rules, and even the controls that do exist leave room for much aid to be granted.

All in all, one could think of the following actions that governments could take in order to limit the granting of wasteful subsidies and encourage those with positive effects on the long run for their economies.

In the case of large federal countries, one might envision some federal control over the incentive packages that sub-federal government levels can offer to companies.

Bankruptcy laws should limit governments' incentives to bailout firms simply in order to save jobs. In other words, they should allow companies to fail at a minimal cost to employment and activity.

The development of offshore funds could help governments resist the temptation of subsidising raw materials of which their country is an exporter. Similarly, improvements in the tax system and in governments' ability to redistribute income directly can decrease the political pressure to use distortive subsidies for redistributive purposes.

Competition authorities should hold SOEs and government agencies to the same standards as private companies regarding the control of anticompetitive behaviour. In particular, the implausibility of recoupment of losses should not be deemed an acceptable defence in predatory pricing cases and in cases involving other types of exclusionary behaviour. This could be complemented by the "public sector competitive neutrality rules" already existing in many countries.

Countries or regional grouping not yet equipped with competition rules on state aids and subsidies should consider introducing them. Even in the absence of such rules, competition authorities should use the tools they possess (especially as regards the repression of anticompetitive unilateral behaviour) in order to address the competition-distorting effects of state aids as much as they can. Since there are many ways for governments to grant aid under the guise of non-targeted, general policy measures, advocacy by competition authorities is also an essential part of the effort to limit the wasteful granting of subsidies.

Competition authorities should therefore be consulted prior to making decisions on state aids with significant potential effects on the markets in a given sector. Finally, cooperation between competition authorities and the relevant Ministries can only facilitate a better evaluation of the pros and cons of specific subsidies.

More generally, some criteria inspired by the recent overhaul of European state aid control policy could probably be adapted in domestic competition laws, subject to taking into account institutional and cultural settings. The most important ones are, (i) the requirement that each subsidy be the focus of an economic analysis precisely identifying which market failure is in need of correction, and the extent to which the aid measure is likely to correct it; (ii) the requirement that a subsidy be granted only if it can be proved that a more transparent, less discriminatory measure (such as an open public tender), or one less costly for public funds (such as the provision of a long-term loan or the purchase of shares by the government, rather than the granting of aid) cannot meet the same goal; (iii) rules limiting the magnitude and duration of aids, and the ability of the same recipient to be granted subsidies on a regular basis; and (iv) a rule implying that when large, distressed firms receive subsidies, they must give away some compensation concession, such as divesting some activities or committing to refrain from using the aid in order to engage in exclusionary behaviour.

Transparency and the availability of *ex post* assessment mechanisms should also be ways to limit special interests' ability to extract subsidies deprived of any economic justification.

NOTE DE RÉFÉRENCE *

par le Secrétariat

1. Point sur la situation des subventions, des aides publiques et de leur contrôle

Remarque préliminaire. Comme on le verra, divers types d'actions gouvernementales peuvent être qualifiés d'aides publiques ou de subventions et nous ne conférons pas ici une définition unique et précise à ces deux termes. Nous les utilisons, dans l'ensemble, indifféremment sauf quand nous nous référons à l'Union européenne (pour laquelle l'expression consacrée est « aides d'État ») ou à l'Organisation mondiale du commerce (qui parle de « subventions » dans le contexte de l'« Accord sur les subventions et les mesures compensatoires »).

1.1 *L'importance des subventions gouvernementales pour les entreprises*

Les gouvernements peuvent subventionner les entreprises de très nombreuses façons. Ils peuvent accorder des subventions directes ou des allègements fiscaux à certaines entreprises, conditionnellement ou non. Ils peuvent subventionner les moyens de production comme la terre, l'énergie, l'eau ou la largeur de bande pour les services de télécommunication soit parce que ces moyens de production sont placés sous leur contrôle, soit parce qu'ils sont commercialisés par des entreprises publiques. Ils peuvent aussi garantir les prêts souscrits par certaines entreprises, permettant ainsi aux bénéficiaires d'emprunter à un taux inférieur à celui du marché. Les banques nationalisées ou celles qui sont étroitement contrôlées par les pouvoirs publics pour des raisons réglementaires peuvent aussi offrir des crédits directs à des conditions préférentielles à des entreprises ou des secteurs ciblés.

Les entreprises publiques sont souvent d'importants intermédiaires pour les aides publiques ou elles en sont les principaux destinataires. Les gouvernements de nombreux pays consacrent des sommes considérables au soutien des entreprises publiques, et en particulier, d'entreprises publiques non rentables. Certains pays ont consacré, dans le passé, une part substantielle de la richesse nationale à ce type d'aide gouvernementale. Par exemple, dans les années 80 et 90, Sri-Lanka a alloué plus de 30% de son budget, soit plus de 10% de son PIB, au « soutien des entreprises publiques ». ¹ Entre 1995 et 2005, 95% des subventions accordées par la Chine à ses entreprises publiques ont bénéficié à des entreprises non rentables. ² Ces pays ont depuis engagé d'importants processus de réforme et de transformation et s'orientent vers une meilleure gouvernance et des solutions qui laissent davantage jouer les mécanismes du marché. Les services d'utilité publique sont sous contrôle étatique dans bien des pays pour fournir à certaines entreprises des moyens de production essentiels, comme l'énergie et l'eau, à des prix inférieurs à ceux du marché.

Les gouvernements peuvent aussi subventionner les entreprises en achetant leurs produits à des prix supérieurs à ceux du marché, ou, moins directement, en obligeant d'autres entreprises à le faire. Ces

* La présente note a été rédigée pour le Secrétariat par David Spector (École d'économie de Paris et MAAP). Les opinions exprimées dans cette note sont celles de l'auteur. Elles ne sauraient être attribuées au Secrétariat ou aux pays membres de l'OCDE. L'auteur invite ceux qui ont des observations à formuler ou des erreurs factuelles à signaler à les lui communiquer à l'adresse électronique suivante: spector@pse.ens.fr.

¹ S. Kelegama, 1993, « Privatization in Sri Lanka: The Experience during the Early Years of Implementation ». Colombo: Sri Lanka Economic Association.

² Annuaire des finances publiques et annuaire statistique de la Chine.

pratiques s'intègrent parfois dans une politique visant ouvertement à atteindre un objectif de politique générale. Dans beaucoup de pays, par exemple, les entreprises de service public sont tenues d'acheter l'énergie renouvelable à des prix réglementés, supérieurs à ceux du marché. Très fréquemment aussi, l'armée achète des armements nationaux à des prix qui sont en général très supérieurs aux prix à l'exportation, ce qui dénote l'existence d'une subvention implicite.

Il n'est pas simple de déterminer si une mesure gouvernementale donnée constitue une aide. Par exemple, dans l'Union européenne (ci-après, l'« UE »), où les aides d'État sont strictement contrôlées, le débat consacré à chaque cas porte en très grande partie sur la question de savoir si la mesure gouvernementale en cause constitue bien une aide. De plus, comme on le verra plus loin, la définition de l'aide varie d'une juridiction à l'autre; par exemple, certaines mesures sont considérées comme constituant une aide aux termes des définitions de l'UE, mais non aux termes de celles de l'Organisation mondiale du commerce (ci-après l'« OMC »), et vice-versa.

La crise financière récente offre une illustration frappante. Avec la quasi-fermeture de certains segments des marchés du crédit, des banques fondamentalement saines, dont la valeur de l'actif dépassait incontestablement celle du passif, étaient menacées de banqueroute à court terme parce qu'elles étaient aux prises avec un manque de liquidités. Ces banques se sont trouvées brusquement privées de la possibilité d'utiliser leurs avoirs à long terme (par exemple, un portefeuille de prêts de longue durée très sûrs) comme garantie pour emprunter et faire face à leurs obligations financières à court terme du fait que le flux de crédit destiné à ces opérations de refinancement s'était soudainement tari. De nombreux gouvernements ont garanti la dette de ces banques (à titre onéreux) pour leur permettre d'emprunter sur les marchés financiers. La question de savoir si cette garantie constitue une aide, et dans l'affirmative, à combien celle-ci s'élève, est discutable. Dans le contexte de la crise financière récente, la Commission européenne a évalué, dans ce cas, le montant de l'aide au montant de la garantie accordée par les pouvoirs publics. On pourrait toutefois considérer autrement le montant de l'aide ou même son existence. Par exemple, dans le cas d'une banque fondamentalement saine, l'existence de la garantie suffit pour que celle-ci ait accès aux marchés du crédit (aux mêmes conditions, ou presque, que l'État) et puisse satisfaire à ses obligations à court terme, ce qui exclut le risque de faillite à court terme et donc la mise en jeu de la garantie. Si, en outre, la banque est fondamentalement saine en ce sens que la valeur de marché de son actif (dans tous les scénarios envisageables après la crise) excède celle de son passif total, sa faillite est aussi exclue à long terme. Sur la base de ce raisonnement, on pourrait soutenir que la probabilité de sa mise en jeu étant nulle, la garantie n'implique aucun coût pour l'État et ne constitue, de ce fait, pas une aide. On pourrait fonder un autre raisonnement encore sur la valeur de la garantie pour la banque bénéficiaire c'est-à-dire sur le montant que celle-ci serait disposée à payer pour l'obtenir ou toute autre mesure reposant sur des données de référence du marché (comme le prix, avant la crise, des contrats d'échange sur le risque de défaillance).

C'est généralement le degré de sélectivité d'une mesure qui détermine si celle-ci doit ou non être considérée comme une aide. Une réduction générale du niveau de l'impôt sur les sociétés n'est jamais considérée comme une aide, mais ce n'est le plus souvent pas le cas d'un allègement fiscal accordé à une entreprise particulière. La situation est toutefois moins nette pour les cas intermédiaires. Une certaine dose d'arbitraire intervient, par exemple, dans la question de savoir si un allègement fiscal ciblant les petites entreprises constitue ou non une aide.

Malgré ces contours incertains, les estimations existantes qui reposent sur des définitions hétérogènes mettent en évidence l'ampleur des subventions et des aides publiques. Les subventions ont, toutefois, eu tendance à diminuer à long terme dans le monde du fait que dans la plupart des pays les interventions gouvernementales ont cédé la place à un plus large recours aux mécanismes du marché et que les besoins de financement des systèmes de santé et de retraite ont pesé de plus en plus sur les budgets nationaux, réduisant la part des autres postes de dépenses. La crise financière a cependant provoqué un retournement à

court terme de cette tendance avec le renflouement, par les pouvoirs publics, d'institutions financières et d'entreprises en difficulté.

Les données disponibles les plus complètes sur les aides publiques sont celles qui couvrent l'Union européenne. Elles montrent qu'en dépit du contrôle rigoureux dont elles font l'objet, ces aides ont atteint un total de 113,4 milliards EUR en 2008, soit 0,94% du PIB de l'UE, abstraction faite des mesures liées à la crise financière.³ Si l'on exclut l'aide aux chemins de fer, le volume des aides d'État a diminué de moitié entre 1992 et 2008, passant de 1% à 0,54% du PIB. L'inclusion des mesures prises face à la crise d'un montant de 212,2 milliards EUR, soit 1,7% du PIB, modifie radicalement le bilan.

Les chiffres de l'UE (même hors mesures de crise) montrent que même lorsqu'ils sont soumis à un contrôle strict, les gouvernements sont enclins à accorder des subventions assez importantes aux entreprises. Cela permet de penser, en l'absence de données très précises sur les pays extérieurs à l'UE, que le total mondial des subventions est probablement très élevé.

Les données sur les pays non membres de l'UE sont plus rares et le plus souvent insuffisamment homogènes. Celles dont on dispose indiquent, toutefois, que le volume des aides publiques et des subventions est important. L'aide à l'agriculture dans les seuls pays de l'OCDE s'est élevée à 318 milliards USD en 2002. Van Beers et van den Bergh (2001)⁴ estiment aussi qu'à l'échelon de la planète, les subventions aux entreprises représentaient 3,6% du PIB mondial au milieu des années 90. Le fait que sur les 63 affaires soumises à l'instance de règlement des différends de l'OMC entre 2001 et 2008, 14, c'est-à-dire 22% du total, concernaient des subventions est une autre indication de l'importance de celles-ci.

Les subventions revêtent des formes variées. Pour n'en citer que quelques unes, les subventions mondiales à l'énergie (qui incluent à la fois les subventions générales à l'énergie, le soutien des charbonnages dans beaucoup de pays et le soutien des énergies renouvelables) s'élèvent à bien plus de 100 milliards USD par an, la part de l'Iran dans ce total atteignant à elle seule 55 milliards USD.

Certaines branches d'activité sont particulièrement susceptibles de recevoir des subventions, surtout en temps de crise. Par exemple, le total des subventions mondiales proposées pour l'industrie automobile des pays développés et des pays en développement se situait aux alentours de 48 milliards USD en 2008. En dehors de la subvention de 17,4 milliards USD accordée par les États-Unis à ses trois constructeurs nationaux, le Canada, la France, l'Allemagne, le Royaume-Uni, la Chine, la Corée du Sud, l'Argentine, le Brésil, la Suède et l'Italie, entre autres, ont aussi accordé des aides directes ou indirectes à leur industrie automobile qui, globalement, sont assez considérables. D'autres secteurs, comme la construction navale et les transports aériens, bénéficient aussi régulièrement de subventions, des problèmes récurrents de surcapacité réduisant leurs marges et incitant les pouvoirs publics à intervenir.

Les raisons pour lesquelles les aides publiques sont octroyées sont aussi variées que la qualité de leurs bénéficiaires. Des subventions gouvernementales ont souvent été utilisées pour favoriser le développement de nouvelles industries dans le cadre d'une politique industrielle « offensive », surtout dans les pays en développement.⁵ C'est le cas, par exemple, de l'aide accordée depuis longtemps par le Brésil au constructeur aéronautique Embraer (entreprise publique privatisée par la suite), des investissements

³ Rapport de la Commission, Tableau de bord des aides d'État, mise à jour de l'automne 2009.

⁴ C. van Beers et J. van den Bergh, 2001, « Perseverance of Perverse Subsidies and Their Impact on Trade and Environment », *Ecological Economics*, vol. 36(3), pp. 475-486.

⁵ Voir la documentation relative à la Table ronde sur la politique de la concurrence, la politique industrielle et les champions nationaux, organisée en 2009 dans le cadre du Forum mondial sur la concurrence: <http://www.oecd.org/dataoecd/12/50/44548025.pdf>.

effectués par Fundación Chile dans de nombreux secteurs et des subventions accordées, dans le passé, par la Corée du Sud pour encourager les conglomérats à diversifier leurs activités. Les subventions consenties aux pôles d'innovation sont un autre exemple de mesure de politique industrielle offensive.

Des subventions sont aussi souvent octroyées dans le cadre d'une politique industrielle « défensive » lorsqu'elles ciblent des entreprises en difficulté dans le but d'éviter une reprise par des intérêts étrangers, la disparition d'une activité jugée essentielle pour l'économie nationale ou des mises à pied et les troubles sociaux qui s'ensuivraient. Entre notamment dans cette catégorie, le soutien récurrent apporté aux constructeurs automobiles, aux compagnies aériennes et aux charbonnages à travers le monde. Dans certains cas, les gouvernements accordent des subventions à des secteurs fragiles comme ceux-ci parce qu'ils estiment qu'ils doivent le faire pour rétablir l'équilibre concurrentiel face aux subventions consenties par leurs homologues étrangers.

Une aide peut aussi être accordée pour encourager des activités considérées comme génératrices d'externalités positives indépendamment du revenu privé qu'elles procurent à l'établissement qui les entreprend. C'est notamment le cas de l'aide octroyée pour les énergies renouvelables et la recherche-développement ainsi que des aides à l'investissement dans les régions en difficulté.

Les pays octroient également des subventions pour attirer des investissements entièrement nouveaux de la part, souvent, d'entreprises étrangères. Cette concurrence entre administrations nationales ou locales donne parfois lieu à des courses aux subventions qui se soldent par l'octroi de sommes considérables tant dans les pays développés que dans les pays en développement. Ces courses aux subventions sont particulièrement fréquentes dans les grands pays fédéraux.

1.2 Le traitement des aides publiques par l'OMC

Les aides publiques et les subventions semblent incompatibles avec l'idée que, dans un contexte de libre concurrence, les mécanismes du marché sont les meilleurs instruments de l'amélioration du bien-être social. Les aides publiques et les subventions s'ingèrent dans la formation des prix et les processus « darwiniens » que la concurrence favorise et qui sont généralement considérés comme l'une des principales forces conduisant à l'efficacité économique (au moins si l'on croit dans les principes qui étaient la politique de la concurrence). On pourrait donc s'attendre à ce qu'elles fassent l'objet d'une surveillance attentive de la part des autorités de la concurrence dans le monde entier. Ce n'est toutefois pas le cas. Ce n'est qu'au sein de l'UE que l'autorité de la concurrence (la Commission européenne) est habilitée à exercer un contrôle rigoureux sur les aides d'État. Dans d'autres juridictions, les autorités de la concurrence exercent un certain contrôle sur les actions d'entités publiques. Mais, dans l'ensemble, si l'on considère globalement les façons dont les aides publiques sont contrôlées, l'ensemble de règles les concernant qui a la plus large portée multilatérale, est celui qui découle de l'Accord sur les subventions et les mesures compensatoires (ci-après, l'« Accord SMC ») auquel ont souscrit tous les membres de l'OMC à la fin du Cycle d'Uruguay.

L'Accord SMC ne prévoit pas un contrôle préalable.⁶ Il contient deux grands ensembles de règles. La « piste I » vise l'imposition, par un État membre, de droits compensateurs aux importations en provenance d'un autre État membre octroyant une subvention préjudiciable à l'industrie nationale du pays qui impose les droits. Les règles de la « piste II » autorisent un État membre à contester devant l'organe de règlement des différends de l'OMC une subvention accordée par un autre État membre.

⁶ Pour un exposé détaillé des règles de l'OMC et un examen de leurs relations avec celles de l'UE, voir C.-D. Ehlermann et M. Goyette, 2006, « The Interface between EU state aid Control and the WTO Disciplines on Subsidies », *European state aid Law Quarterly*, vol. 2006 (4), pp. 695-718.

Aux termes de l'Accord SMC, une mesure constitue une subvention si (i) elle implique une contribution financière des pouvoirs publics, (ii) elle confère un avantage à ses bénéficiaires, et (iii) elle est spécifique à une entreprise ou à une branche de production ou à un groupe de branches de production. En pratique, le critère (i) est interprété dans un sens très large dans le droit de l'OMC dans la mesure où une instruction donnée par les pouvoirs publics à des entreprises privées d'accorder un avantage à certaines entreprises est considérée comme suffisante pour satisfaire au critère, même si elle n'implique aucun coût effectif pour les pouvoirs publics. Le critère de sélectivité est, par contre, interprété très étroitement. Par exemple, une mesure ne bénéficiant qu'à de petites entreprises ou qu'aux entreprises d'une région donnée, n'est pas considérée comme remplissant la condition (iii).

Toutes les subventions ne sont pas illégales au regard du droit de l'OMC. Une fois qu'une mesure est classée comme une subvention, elle peut être considérée comme une subvention prohibée ou « pouvant donner lieu à une action ». Les subventions à l'exportation et les subventions au remplacement des importations sont interdites en tant que telles en vertu du droit de l'OMC. Toutes les autres subventions peuvent donner lieu à une action, ce qui veut dire que pour qu'un pays impose des droits compensateurs ou saisisse l'organe de règlement des différends, il doit prouver que la subvention lui porte préjudice.

Quatorze affaires concernant des subventions ont été portées devant l'organe de règlement des différends entre 2001 et 2008. Ce chiffre ne permet toutefois pas de mesurer l'effet réel des règles de l'OMC c'est-à-dire essentiellement le degré auquel celles-ci dissuadent en fait les pouvoirs publics d'accorder une aide.

1.3 Le contrôle des aides d'État dans l'Union européenne

La Commission européenne exerce un contrôle sur les aides d'État. Ce contrôle est, en fait, antérieur à la création de l'UE en 1957 (qui s'appelait alors la « Communauté européenne ») puisqu'il constituait déjà un aspect essentiel du traité instituant la Communauté européenne du charbon et de l'acier en 1951 (avec les six mêmes membres fondateurs que la Communauté européenne, à savoir: la France, l'Allemagne, l'Italie, la Belgique, les Pays-Bas et le Luxembourg). La principale raison d'être du contrôle des aides publiques était alors l'intégration des marchés des États membres.⁷ Ce contrôle devait notamment permettre d'éviter une intégration verticale artificielle sur une base nationale dans le cadre de laquelle chaque producteur de charbon vendrait sa production à des conditions préférentielles aux producteurs d'acier du même pays.

L'article 107, paragraphe 1 du Traité sur le fonctionnement de l'Union européenne interdit les aides accordées par les États qui faussent ou qui menacent de fausser la concurrence dans la mesure où elles affectent les échanges entre les États membres. Toutefois, les aides d'État qui contribuent à la réalisation d'objectifs bien définis d'intérêt européen commun sans fausser exagérément la concurrence entre les entreprises et les échanges entre les États membres peuvent être considérées comme compatibles avec le marché intérieur (article 107, paragraphe 3). Une différence importante entre les règles de discipline de l'UE et de l'OMC est que le contrôle de l'UE est effectué préalablement: un État membre qui a l'intention d'accorder une aide ou d'adopter une mesure qui pourrait constituer une aide (si elle ne constitue pas une forme patente d'aide) doit tout d'abord solliciter l'autorisation de la Commission. Une similitude importante entre les deux systèmes est qu'ils ne visent que les aides publiques qui faussent la concurrence (au moins partiellement) dans les pays qui sont parties aux accords respectifs.

En pratique, surtout depuis la diffusion, en 2005, du Plan d'action dans le domaine des aides d'État, le traitement de chaque cas par la Commission s'articule autour du « critère de mise en balance ».

⁷ G. Grin, 2003, *The Battle of the Single European Market: Achievements and Economic Thought, 1945-2000*, Londres: Kegan Paul.

L'application de ce critère consiste principalement à déterminer l'objectif de l'aide, établir si l'aide est un instrument approprié (en ce sens qu'elle permettra d'atteindre l'objectif qui est censé être visé et ne pourrait être atteint par aucune autre mesure moins créatrice de distorsions) et, enfin, à mettre en balance les effets positifs attendus de l'aide et les distorsions anticipées de la concurrence.

La première étape de l'analyse implique souvent de définir les défaillances du marché que la mesure d'aide doit corriger. Cette démarche s'inscrit dans le droit fil de la philosophie générale qui sous-tend la politique de la concurrence, c'est-à-dire l'idée que les marchés sont en général efficaces. Le deuxième critère est très important en pratique. En effet, lorsqu'une mesure d'aide est destinée à rétribuer une entreprise pour la fourniture d'un « service d'intérêt économique général », la Commission est généralement amenée à demander pourquoi un appel d'offres ouvert et non discriminatoire (non considéré comme constituant une aide depuis la décision *Altmark*⁸) ne pouvait permettre d'atteindre le même objectif que l'aide. En d'autres termes, le deuxième volet du critère limite fortement la possibilité pour les gouvernements d'octroyer une aide.

Ces principes généraux ont été à la base des diverses lignes directrices couvrant différents types d'aide, publiées par la Commission au cours des dernières années, comme le Règlement général d'exemption par catégorie et les lignes directrices sur les aides à la recherche et au développement, les aides visant à promouvoir les investissements en capital-investissement dans les petites et moyennes entreprises, les aides pour la protection de l'environnement et les aides à finalité régionale, etc. (cette liste n'est pas exhaustive). Avec l'éclatement de la crise financière en août 2008, la Commission a aussi publié des lignes directrices concernant les aides d'État au sauvetage et à la restructuration d'entreprises en difficulté ainsi que diverses communications sur le traitement de la crise financière y compris, tout d'abord, la « Communication de la Commission sur le retour à la viabilité et l'appréciation des mesures de restructuration dans le secteur financier dans le contexte de la crise actuelle, conformément aux règles relatives aux aides d'État ». Elle a également diffusé des lignes directrices sur les aides accordées pour faire face à la crise dans l'économie réelle (c'est-à-dire les aides consenties aux entreprises non financières touchées par la réduction spectaculaire des crédits disponibles) avec « le cadre communautaire temporaire pour les aides d'État destinées à favoriser l'accès au financement dans le contexte de la crise économique et financière actuelle ».

Les règles de l'UE passent généralement pour être plus rigoureuses que celles de l'OMC, mais ce n'est pas toujours vrai. Par l'exemple, d'après la Cour de justice européenne, une mesure gouvernementale obligeant des entités privées à subventionner d'autres entités privées ne constitue pas une aide aux termes des règles de l'UE si elle n'implique pas un coût direct pour l'État concerné.⁹ Le droit communautaire prend aussi en considération l'effet d'une mesure sur les échanges entre les États membres de l'UE (qui regroupe, bien sûr, moins de pays que l'OMC).

Il convient de noter que l'interprétation par la Commission ou les instances juridiques européennes de la notion d'incidences sur les échanges entre les États membres ou de distorsion de la concurrence a évolué au fil du temps. Tout d'abord, le niveau des critères appliqués a changé. Avant l'arrêt du Tribunal de première instance des Communautés européennes (TPICE) dans l'affaire *Tubemeuse*¹⁰, la Commission européenne a eu tendance à considérer que les conditions requises étaient nécessairement remplies dès qu'une aide était accordée et qu'il était donc inutile de procéder à une enquête spécifique. Dans le cadre de l'arrêt susmentionné, le TPICE a confirmé une décision de la Commission européenne interdisant une aide

⁸ Affaire C-280/00 *Altmark Trans GmbH et Regierungspräsidium Magdeburg contre Nahverkehrsgesellschaft Altmark GmbH* [2003].

⁹ Affaire C-379/98 – *PreussenElektra AG contre Schleswig AG*, Rec. 2001, p. I-2099.

¹⁰ Affaire 102/87, Rec.1988, p. 4067.

octroyée par le gouvernement belge bien que le bénéficiaire de celle-ci vendît surtout à l'extérieur de la CE. Il a soutenu que ni le volume des échanges intracommunautaires sur le marché concerné, ni l'ampleur de l'aide n'importaient pour conclure à l'existence d'un risque de distorsion ou de perturbation des échanges entre les États membres. Le TPICE a également affirmé que « *l'importance relativement faible d'une aide [...] n'exclu[en]t pas a priori la possibilité que les échanges entre les États membres soient affectés* ». Le TPICE a donc estimé que la Commission européenne devait certes examiner en bonne et due forme les situations de distorsion de la concurrence et d'incidences sur les échanges, mais qu'elle était soumise à une très faible charge de preuve puisqu'il lui suffisait d'établir qu'une distorsion de la concurrence ou des incidences sur les échanges ne pouvaient être exclues *a priori*.

La décision *Wam*¹¹, prise récemment, constitue peut-être un tournant. Ce n'est pas la première décision à avoir annulé une interdiction de la Commission, mais elle l'a fait en fixant un critère qui semble plus contraignant que ceux qui avaient été appliqués jusque-là dans la plupart des cas. Le TPICE a estimé que le fait que le bénéficiaire de l'aide participe à des échanges intra-européens n'était en soi pas suffisant pour que la Commission conclue que cette aide affecterait les échanges entre États membres: « *le seul constat de la participation de Wam aux échanges intracommunautaires est insuffisant pour étayer une affectation desdits échanges ou une distorsion de concurrence et, dès lors, nécessite une analyse approfondie des effets des aides* ».¹²

Outre la question des critères appliqués, la façon dont ces notions de concurrence et d'incidences sur les échanges a été interprétée a également évolué au fil des ans. Dans l'affaire Philip Morris¹³, le TPICE a soutenu que la distorsion de la concurrence correspondait à une modification de la position d'une entreprise par rapport à d'autres dans le contexte des échanges intracommunautaires. Mais dans « *L'encadrement communautaire des aides d'État à la recherche, au développement et à l'innovation* », la Commission européenne mentionne aussi les délocalisations parmi les formes de distorsion possibles,¹⁴ bien que celles-ci puissent se produire indépendamment de tout effet sur les concurrents (dans le cas, par exemple, de l'octroi d'une aide à un monopole non menacé par une entrée potentielle).

La position de la Commission a aussi progressivement évolué à l'égard des structures de marché favorisant davantage, selon elle, les distorsions de concurrence. Dans plusieurs affaires (*Imepiel*¹⁵, *Ramondin*¹⁶), elle a estimé que le risque de distorsion était plus grand sur un marché fortement concurrentiel. Cela a même fait l'objet d'un point d'intérêt général dans les lignes directrices concernant les aides d'État dans le secteur automobile puisque la Commission a rappelé dans sa décision relative aux camions DAF: « *Au point concernant les aides à la modernisation et à l'innovation, l'encadrement prévoit que 'sur un véritable marché intérieur de l'automobile, la concurrence entre les constructeurs deviendra encore plus forte et les distorsions provoquées par les aides encore plus importantes. En conséquence, la Commission adoptera une attitude ferme à l'égard des aides à la modernisation et à l'innovation'* ».¹⁷ Mais, dans les lignes directrices qu'elle a adoptées récemment pour les aides d'État à la recherche, au développement et à l'innovation, la Commission adopte un point de vue différent en affirmant que les aides

¹¹ TPICE, 6 septembre 2006, Italie et Wam SpA contre Commission, affaire T 304/04.

¹² Point 74 de l'arrêt.

¹³ Affaire 730/79, Rec. 1980, p. 2671.

¹⁴ Point 7.4 de l'Encadrement communautaire des aides d'État à la recherche, au développement et à l'innovation.

¹⁵ J.O. L 172 du 27.06.1992, p. 76.

¹⁶ J.O. L 318 du 16.12.2000, p. 36.

¹⁷ J.O. L 015 du 20.01.1996, p. 37 à 45.

d'État risquent moins de fausser les mesures d'incitation dynamiques ou de créer des situations de pouvoir de marché sur des marchés très concurrentiels.¹⁸

Le contrôle des aides d'État dans l'Union européenne est progressivement passé d'une approche purement légaliste à une approche axée sur les effets. Cette évolution dans la juridiction qui a la plus longue expérience de ce contrôle confirme qu'il est nécessaire de mieux évaluer les conséquences économiques des aides et des subventions publiques dans les différents pays.

1.4 Le contrôle des aides et des organismes publics en dehors de l'UE

D'autres blocs commerciaux régionaux disposent aussi de règles spécifiques pour contrôler les aides publiques. Par exemple, l'Union économique et monétaire ouest-africaine (UEMOA), qui regroupe le Bénin, le Burkina Faso, la Côte d'Ivoire, la Guinée Bissau, le Mali, le Niger, le Sénégal et le Togo, a adopté, en 2002, des lignes directrices relatives à la concurrence qui interdisent les accords anticoncurrentiels, les abus de position dominante et « les aides publiques susceptibles de fausser la concurrence en favorisant certaines entreprises ou certaines productions ». Toutefois, d'après la contribution de l'UEMOA, ces règles ne sont pas encore suffisamment soutenues par les États membres pour être appliquées efficacement.

D'autres zones de libre-échange ont des règles qui limitent les subventions, comme la Communauté andine dont la décision 45725 vise à empêcher ou à corriger les distorsions de concurrence provoquées par les subventions dont bénéficient les produits importés d'autres États membres.¹⁹

Les aides d'État relèvent aussi, au moins théoriquement, de la compétence des autorités nationales de la concurrence dans certains pays extérieurs à l'UE. Par exemple, la législation russe de la concurrence, sur laquelle repose le contrôle des aides publiques en Russie, s'applique non seulement aux entreprises, mais aussi aux autorités exécutives de l'État. Aux termes des articles 7 et 8 de la loi antimonopole, les actions et les accords d'organes du pouvoir exécutif qui limitent l'indépendance économique des entreprises ou créent des conditions favorables ou discriminatoires pour certaines entreprises sont interdites. Une réforme législative récente a accordé à l'autorité antimonopole le pouvoir d'exercer un contrôle avant la prise de décisions par les organes du pouvoir exécutif. Les décisions relatives à l'octroi de privilèges à des entreprises particulières ou à des groupes d'entreprises doivent être approuvées par l'autorité antimonopole.

La loi antimonopole de la Chine, entrée en vigueur en 2008, comporte un chapitre incluant six dispositions distinctes qui interdisent certaines formes d'abus de pouvoir administratif qui ont pour effet d'empêcher ou de restreindre la concurrence. Ces interdictions mentionnent expressément certaines initiatives gouvernementales (par exemple, la fixation de normes d'inspection discriminatoires ou la réalisation, de façon discriminatoire, d'inspections répétées) qui peuvent aller plus loin que la définition européenne des aides d'État.

Les autorités de la concurrence de pays candidats à l'entrée dans l'UE, comme la Croatie et la Turquie, exercent aussi un certain contrôle sur les aides publiques. En outre, plusieurs pays (comme le Pakistan et le Pérou, entre autres) ont indiqué dans les documents qu'ils ont soumis pour cette table ronde du Forum mondial sur la concurrence que leur droit de la concurrence s'applique aux entreprises publiques, mais aussi plus généralement aux entités publiques.²⁰

¹⁸ Sections 7.4.1. et 7.4.2.

¹⁹ <http://www.comunidadandina.org/normativa/dec/D457.htm>

²⁰ Voir <http://www.oecd.org/competition/globalforum>.

Enfin, de nombreux pays comme le Brésil, l'Australie, la Hongrie, le Pérou et la Norvège, disposent de lois soumettant les organismes et entreprises publics au « principe de neutralité concurrentielle »²¹. Celui-ci implique, d'une manière générale, que les entreprises publiques ne doivent pas bénéficier d'un avantage concurrentiel par rapport aux autres entreprises simplement parce qu'elles relèvent du secteur public.²² Dans certains cas, les entreprises privées et les particuliers ont accès à des mécanismes de réclamation gérés par les organismes chargés de la concurrence.²³ Les autorités de la concurrence de nombreux pays sont en outre consultées sur des questions pouvant impliquer des aides publiques comme la conception d'appels d'offres publics ou de processus de privatisation.

1.5 Les points de rencontre entre les subventions et le droit de la concurrence: prix d'éviction et contrôle des fusions

En dehors des divers régimes visant directement les aides publiques que nous venons d'examiner, les autorités de la concurrence peuvent être amenées à s'occuper de ces aides, au moins indirectement, dans deux types de circonstances (même en l'absence d'instruments juridiques directement liés aux aides d'État) en mettant en œuvre la politique de la concurrence même sans sortir de ses limites « traditionnelles ».

Le premier type de circonstances, qui est aussi le plus fréquent, est celui de l'utilisation par des entreprises (publiques, le plus souvent) de subventions gouvernementales pour pratiquer des prix d'éviction ou se livrer à d'autres pratiques d'exclusion. Au sein de l'UE, l'affaire marquante qui illustre cette question est celle de la société *Deutsche Post*.²⁴

Au moment où elle s'est livrée à ce type de pratiques (les années 90), la société *Deutsche Post* était une entreprise publique active sur deux marchés très différents. D'une part, elle gérait le monopole du courrier en Allemagne, à des prix administrés et en fournissant un service public réglementé. D'autre part, elle était active sur le marché de la livraison de colis qui était ouvert à la concurrence, notamment celle de United Parcel Service (UPS) et de Federal Express. UPS s'est plaint auprès de la Commission européenne du fait que la société *Deutsche Post* utilisait les recettes tirées du monopole de l'envoi de courrier pour financer des ventes à perte pour ses services de transport de colis. En mars 2001, la CE a conclu que pendant cinq ans la société *Deutsche Post* n'avait pas couvert ses coûts différentiels par sa tarification des services de transport de colis et qu'elle s'était donc rendue coupable d'abus de position dominante.

On peut penser, à première vue, que les cas de fixation de prix d'éviction ne manquent pas et que le fait que l'entreprise prédatrice soit une entreprise publique n'a rien de spécial. Cette impression est toutefois trompeuse en raison de deux particularités des entreprises publiques. Tout d'abord, la définition des coûts différentiels associés à l'activité exercée sur un marché concurrentiel dépend des coûts qui sont attribués au service public. La décision concernant la société *Deutsche Post* précise que tous les coûts qui sont nécessaires pour remplir la mission de service public doivent être entièrement imputés à cette mission même s'ils contribuent aussi aux activités exercées sur le marché concurrentiel. Une affaire similaire a concerné la société Telkom, l'ancien monopole sud-africain des télécommunications, qui a été accusée

²¹ Voir la documentation de l'OCDE d'octobre 2009 sur les entreprises publiques.

²² Voir, par exemple, l'accord sur les principes de la concurrence conclu, en Australie, entre l'État fédéral et les États et territoires fédérés.

²³ L'accord susmentionné stipule aussi que chaque administration doit établir un mécanisme de réclamation. Dans le cas de l'État fédéral, c'est le Bureau des plaintes relatives à la neutralité concurrentielle de la Commission de la productivité et, dans le cas des administrations régionales, c'est, par exemple, l'autorité de la concurrence du Queensland, la Commission de la concurrence et de l'efficacité de l'État de Victoria et la Commission indépendante de la concurrence et de la réglementation (ICRC) du Territoire de la capitale australienne (ACT).

²⁴ Affaire COMP/35.141 (2001/354/CE).

d'utiliser les profits qu'elle tirait de son monopole pour les services vocaux réglementés pour financer ses services Internet à large bande, ce qui se traduisait par des prix d'éviction pour cette catégorie de services. Le Pérou mentionne des affaires du même ordre dans sa communication: « *on dénombre jusqu'à présent six affaires (...) dans lesquelles les plaignants ont argué qu'un hôpital public fournissait aux patients des services médicaux qui seraient autrement offerts dans des hôpitaux privés.* »

L'application du critère fixé dans l'affaire *Deutsche Post* s'avère parfois complexe. Par exemple, dans le cadre d'une affaire récente portant sur le transport maritime entre une île française et le continent, dans laquelle un bateau coûteux (et fortement subventionné) était utilisé pour fournir un service public réglementé et subventionné (en hiver) et un service assuré dans des conditions concurrentielles (en été), le test visant à établir l'existence d'une pratique de prix prédateurs reposait sur la question suivante: le coût du bateau devait-il être intégralement imputé à la mission de service public ou devait-il être en partie inclus dans le coût différentiel de la prestation du service dans des conditions concurrentielles (en été) du fait qu'un bateau de plus petite taille aurait pu être utilisé pour assurer le service en hiver?²⁵ Ces exemples montrent que même pour l'application d'un concept « traditionnel » du droit de la concurrence, comme celui de la tarification prédatrice, les autorités de la concurrence peuvent être amenées à évaluer le coût de la fourniture d'un service public réglementé – ce qui n'est guère différent de ce que fait la Commission européenne lorsqu'elle cherche à déterminer si la rémunération, par les pouvoirs publics, de services d'intérêt économique général constitue une subvention.

Une deuxième différence entre les entreprises publiques et privées dans le cas des plaintes concernant des prix d'éviction ou des plaintes de nature plus générale portant sur des pratiques d'exclusion est que les entreprises publiques n'ont souvent pas comme objectif de maximiser leurs profits, mais plutôt de maximiser à la fois leurs profits et leur taille.²⁶ Cela implique que même dans des situations où des pratiques d'exclusion sont incompatibles avec la maximisation du flux escompté de profits à l'avenir (du fait, par exemple, qu'une récupération des pertes est peu probable après l'élimination d'un concurrent en l'absence de barrières à l'entrée), les entreprises publiques peuvent être tentées malgré tout de recourir à ces pratiques, alors que ce ne serait pas le cas pour des entreprises privées dans la même situation. Cette observation a poussé certains auteurs à soutenir que les abus visant à exclure la concurrence devraient être sanctionnés plus sévèrement lorsqu'ils sont le fait d'entreprises publiques et que l'application du critère de la « récupération » des pertes, auquel il est procédé dans le cadre de l'évaluation des plaintes portant sur des prix d'éviction aux États-Unis, conduirait à une sanction trop clémente.²⁷

Un autre domaine dans lequel on observe un lien moins direct entre les subventions et la politique de la concurrence est celui des fusions. Les gouvernements désireux de décourager des fusions entre entreprises privées pour des raisons de « politique industrielle » ou de nationalisme économique peuvent, dans certains cas, menacer de réduire les subventions, ou d'une manière plus générale, de durcir les conditions des opérations commerciales effectuées avec les pouvoirs publics (dans le cas d'entreprises vendant à des entités publiques ou à des prix administrés, ou achetant des moyens de production à des entités publiques). Par exemple, il est parfois avancé que lorsque l'entreprise pharmaceutique suisse Novartis et l'entreprise pharmaceutique française Sanofi ont été en concurrence pour l'achat d'Aventis, le gouvernement français a fait peser son influence sur les négociations des prix des médicaments pour favoriser la fusion de deux entreprises françaises. Cela est dans le droit fil de l'observation empirique

²⁵ Autorité française de la concurrence, décision #04-D-79; arrêt du 17 juin 2008 de la Cour de cassation.

²⁶ Voir, par exemple, W. Niskanen, 1971, *Bureaucracy and Representative Government*, Aldine Transaction; William Niskanen, 1975, *Bureaucrats and Politicians*, *Journal of Law and Economics*, vol. 18.

²⁷ D. Sappington et G. Sidak, 2003, « Competition Law for State-Owned Enterprises ». *Antitrust Law Journal*, vol. 71 (2), 479-523 ; 2000, « Are Public Enterprises the Only Credible Predators? », *University of Chicago Law Review*, vol. 67 (1), pp. 271-292.

indiquant que les pays qui comptent un fort pourcentage d'entreprises étrangères ont aussi tendance à taxer assez fortement les entreprises.²⁸

En dépit des interactions précédemment mentionnées entre le droit de la concurrence et les subventions, on constate dans l'ensemble que les aides publiques sont relativement peu contrôlées en dehors de l'Union européenne du fait que les règles de l'OMC ne couvrent que certaines catégories d'aide (à savoir celles qui peuvent porter préjudice aux autres pays et donner lieu à des plaintes soumises à l'organe de règlement des différends). Cela incite à examiner l'effet des aides publiques. Nous allons donc procéder maintenant à un examen des effets négatifs possibles de ces aides et des circonstances dans lesquelles leur utilisation peut se justifier.

2. L'effet négatif possible des aides publiques

2.1 Une donnée de base: le coût des fonds publics

Avant de considérer l'utilité éventuelle des aides publiques et des subventions, il est important de rappeler que la collecte des fonds publics entraîne des coûts directs (coûts administratifs) et indirects (en raison de l'effet de distorsion de l'imposition) et que l'octroi d'une aide se fait au détriment d'autres dépenses publiques qui auraient pu être très productives.

D'après des estimations empiriques, la collecte de 100 dollars pour l'administration centrale implique une perte sèche de 18 à 24 dollars: quand l'administration centrale collecte 100 dollars, d'autres agents économiques perdent non pas 100 dollars, mais entre 118 et 124 dollars.²⁹ Ces chiffres concernent les États-Unis, et on peut supposer que le coût des fonds publics est plus élevé dans les pays en développement.

Du côté des dépenses, Les subventions constituent une dépense si importante dans certains pays en développement que s'ils les réduisaient les gouvernements pourraient accroître considérablement les sommes qu'ils consacrent à la santé ou à l'éducation. Par exemple, en réorientant vers l'éducation de base les subventions d'exploitation qu'elles accordent aux entreprises publiques (qui ne représentent qu'une partie de l'ensemble des subventions qu'elles leur octroient), les administrations centrales du Mexique, de la Tanzanie, de la Tunisie et de l'Inde pourraient augmenter les dépenses qu'elles consacrent à l'éducation de 50, 74, 160 et 550 %, respectivement. De même, en réorientant vers les soins de santé les subventions accordées aux entreprises publiques, l'État sénégalais pourrait plus que doubler ses dépenses nationales de santé et les administrations centrales de la Turquie, du Mexique, de la Tunisie et de l'Inde pourraient, respectivement, tripler, quadrupler et quintupler leurs dépenses de santé.³⁰

Ces chiffres sont importants parce qu'ils impliquent que le coût d'opportunité des aides publiques est très élevé. D'après les estimations existantes, le rendement social de l'investissement public dans l'éducation est d'environ 8,5% dans les pays de l'OCDE, mais de plus de 20% dans les pays en

²⁸ H. Huizinga et G. Nicodème, 2006, « Foreign ownership and corporate income taxation: An empirical evaluation ». *European Economic Review*, pp.1223-1244.

²⁹ C. Ballard, J. Shoven et J. Whalley, 1985, « General Equilibrium Computations of the Marginal Welfare Costs of Taxes in the United States », *American Economic Review*, vol. 75 (1), p. 128-138; D. Jorgenson et K. Yun, 1990, « Tax Reform and US Economic Growth », *Journal of Political Economy*, vol. 98 (5) ; D. Jorgenson et K. Yun, 1991, « The Excess Burden of Taxation in the United States », *Journal of Accounting and Finance*, vol. 6 (4), p. 487.

³⁰ D.A.C. Smith et M.J. Trebilcock, 2001, « State-owned Enterprises in Less Developed Countries: Privatization and Alternative Reform Strategies », *European Journal of Law and Economics* vol. 12 (3), pp. 217-252.

développement.³¹ Ces chiffres impliquent que les aides publiques devraient être évaluées par rapport à un critère solide. Les aides qui ne sont en fait que des transferts globaux représentent un énorme gaspillage de ressources (sauf si ces transferts contribuent à la réalisation d'un objectif distributif légitime et bien défini) du fait qu'elles utilisent des fonds publics qui sont coûteux à réunir et qui auraient pu être utilisés de façon plus productive s'ils avaient été alloués à la santé ou à l'éducation.

2.2 L'ampleur et le coût économique des courses aux subventions

On peut se demander pourquoi les gouvernements octroient des subventions quand ils pourraient utiliser plus efficacement les deniers de l'État.

Cela tient souvent à l'existence d'externalités négatives entre les juridictions, c'est-à-dire entre les pays ou entre les régions d'un pays. En bref, l'octroi d'une aide peut sembler judicieux du point de vue limité d'une administration locale ou nationale, mais lorsqu'il a pour effet de transférer l'activité économique d'une région vers une autre (ou d'un pays vers un autre), il est somme toute presque inutile et représente un gaspillage de ressources publiques.

Les pertes sèches liées à la fiscalité et le coût d'opportunité des fonds publics étant élevés, les aides publiques risquent d'être accordées en pure perte même lorsqu'elles ne sont pas directement à l'origine de distorsions (l'observation du fait que ces aides créent en outre souvent de graves distorsions qui sont préjudiciables à l'efficacité économique et à l'environnement est examinée plus loin).

Le mécanisme qui joue derrière l'externalité est le suivant. La décision d'une entreprise d'établir, développer ou maintenir une usine dans un pays a souvent des effets positifs non négligeables pour ce pays ou la région concernée sous la forme des recettes fiscales perçues (directement auprès de l'entreprise ou indirectement par l'intermédiaire des salaires de ses employés), d'une baisse éventuelle du chômage et des coûts qui lui sont liés, de l'augmentation de la demande pour la production des entreprises locales, etc. Elle peut aussi se solder par un transfert de compétences au profit de la main-d'œuvre locale qui peut ensuite bénéficier plus largement à l'économie en cas de changement d'employeur. Toute administration nationale ou locale peut donc avoir intérêt à accorder des aides pour attirer des entreprises sur son territoire. La concurrence entre les administrations nationales ou locales désireuses d'attirer ou de retenir les mêmes entreprises risque de se traduire par l'octroi de gros volumes d'aide ayant pour effet de déplacer les activités des entreprises plutôt que d'en créer de nouvelles.

En théorie, les courses aux subventions pourraient avoir un effet positif, plutôt que négatif, sur le bien-être général. Ce pourrait être le cas si deux conditions étaient réunies: (i) un faible niveau des pertes sèches liées à la fiscalité et du coût d'opportunité des fonds publics, et (ii) une forte variation d'un endroit à l'autre des retombées positives de la présence d'une entreprise. Dans ce cas, les pays ou les régions dans lequel(le)s la présence d'une entreprise aurait les plus fortes retombées favorables seraient disposé(e)s à « offrir » des montants plus importants que ceux ou celles dans lequel(le)s ces retombées seraient moindres. Tout comme la concurrence par les prix, la concurrence internationale dans ce domaine révélerait où les effets positifs externes sont les plus importants et cela inciterait les entreprises à s'implanter là où leur présence est le plus utile, ce qui serait souhaitable.³²

³¹ G. Psacharopoulos et H.A. Patrinos, 2004, « Returns to investment in education: a further update », *Education Economics*, vol. 12 (2), pp. 111-134.

³² W. Tiebout, 1956, « A pure theory of local expenditures », *Journal of Political Economy*, vol. 64 (5), p. 416; T. Besley et P. Seabright, 1999, « The Effects and Policy Implications of state aids to Industry: an Economic Analysis », *Economic Policy*, pp. 15-53.

Si, comme c'est généralement le cas (comme on l'a vu plus haut), les pertes sèches liées à la fiscalité et le coût d'opportunité des fonds publics sont importants et si les courses aux subventions n'orientent pas les investissements directs vers les régions dans lesquelles ils ont le plus fort effet positif externe, les courses aux subventions risquent d'être stériles.

Les publications disponibles sur les États-Unis, où les aides ne sont pas interdites, montrent que la concurrence que se font les États pour attirer les entreprises peut être coûteuse. Les États semblent se livrer une concurrence acharnée pour attirer sur leur territoire les activités établies chez leurs voisins, souvent sans que cela se traduise par la création de nouvelles activités.³³ Le simple déplacement d'une entreprise (par opposition à l'encouragement de la création d'une nouvelle activité) a peu de chances d'avoir des effets positifs nets sauf si le bilan coûts/avantages varie notablement entre les régions du pays concerné. Cette concurrence entre les États semble aussi s'être intensifiée récemment,³⁴ ce qui a incité certains auteurs américains à préconiser l'instauration d'un contrôle fédéral des aides publiques.³⁵

Même dans l'Union européenne, où le contrôle des aides d'État est censé limiter le déclenchement de guerres des subventions stériles et où on pourrait s'attendre à ce que la concurrence par les subventions n'ait que des effets « vertueux » en réorientant les investissements vers les endroits où ils généreront les plus fortes externalités positives, l'évaluation des aides existantes dans les publications n'est pas très positive. D'après une étude récente, si la politique régionale visant à attirer les entreprises vers les endroits défavorisés ou périphériques semble avoir atteint son objectif, son coût a été très élevé car la distorsion des choix d'emplacement des entreprises s'est traduite par un manque notable d'efficacité.³⁶ Les arguments en faveur de l'utilisation des aides publiques pour réduire les inégalités régionales ne sont donc peut-être pas très convaincants et d'autres mesures, comme des transferts directs de revenu, pourraient s'avérer plus efficaces dans de nombreux cas.³⁷

La situation est la même dans le monde en développement où les exemples de guerres des subventions, tout à fait stériles, abondent, les administrations régionales de grands pays fédéraux se livrant souvent, entre elles, à une surenchère pour attirer l'investissement.

Un exemple récent est celui de la concurrence qui a opposé plusieurs États indiens pour obtenir l'implantation sur leur territoire de l'usine que l'entreprise Tata Motors souhaitait construire pour la fabrication d'une nouvelle voiture à bas prix, destinée principalement au marché indien. Il a finalement été décidé d'établir cette usine dans l'État du Bengale occidental après que celui-ci eut offert un ensemble très intéressant de mesures d'incitation incluant l'octroi de prêts au taux préférentiel de 1%, des prix subventionnés pour l'électricité (se traduisant par une remise de plus de 25%) et les terrains, et des exonérations fiscales.

Cet exemple illustre surtout l'intensité de la concurrence entre les États indiens. Plus précisément, pendant la « guerre des enchères » qui les a opposés, le Bengale occidental s'est engagé à s'aligner sur les

³³ R. Tannenwald, 2002, « Are State and Local Revenue Systems becoming Obsolete? », *National Tax Journal*, vol. 55 (2), p. 467.

³⁴ K. Chi et D. Leatherby, 1997, *State Business Incentives: Trends and Options for the Future*, Lexington, Kentucky: Council of State Governments.

³⁵ P. Enrich, 1996, « Saving the States from Themselves: Commerce Clause Constraints on State Tax Incentives for Business », *Harvard Law Review*, vol. 110 (2), p. 377.

³⁶ K.-H. Midelfart-Knarvik et H.-G. Overman, 2002, « Delocation and European Integration: Is structural spending justified? », *Economic Policy*, vol. 35, pp. 322-359.

³⁷ K.-H. Ulltveit-Moe, 2007, « Regional policy design: An analysis of relocation, efficiency and equity », *European Economic Review*, vol. 51, p. 1443-1467.

mesures d'incitation offertes par les deux autres États (Uttarakhand et Himachal Pradesh). Si, comme c'est probablement le cas, l'enjeu était le lieu d'implantation de l'usine plutôt que le principe de son existence en Inde, cette course aux subventions a sans doute été stérile sauf si le bilan coûts/avantages varie considérablement à l'intérieur du pays.

Cet exemple est loin d'être unique dans les pays en développement. Par exemple, à la fin des années 90, une intense guerre de subventions a opposé les États brésiliens qui tentaient d'attirer des usines de construction automobile.³⁸ En effet, en 1995 et 1996, l'État du Paraná et la municipalité de Sao Jose ont offert à Renault un ensemble de mesures avantageuses comprenant une contribution financière d'environ 300 millions USD et des tarifs d'électricité subventionnés, lançant ainsi ce que l'on a appelé la « guerre fiscale » entre les États brésiliens.

Des guerres de subventions similaires ont aussi eu lieu en Asie de l'Est. En 1996, la Thaïlande et les Philippines se sont livrées une bataille acharnée pour attirer sur leur territoire une usine automobile de General Motors. C'est finalement la Thaïlande qui l'a emporté en s'alignant sur l'offre des Philippines et en proposant, en outre, de rembourser intégralement les matières premières entrant dans les exportations d'automobiles et de verser une subvention de 15 millions USD pour la création d'un institut de formation General Motors. Il est intéressant de noter que, là encore, General Motors avait fait connaître son intention de construire une usine de construction automobile de 500 millions USD en Asie, quelles que soient les subventions accordées. Selon toute probabilité, les subventions consenties n'ont donc pas contribué à créer de nouvelles activités économiques et n'ont influé que sur le lieu d'implantation d'une usine qui aurait de toute façon été construite.

Ces guerres de subventions ne sont nullement limitées à l'industrie automobile. Depuis le milieu des années 90, plusieurs pays d'Asie de l'Est ont lancé divers dispositifs d'incitation incluant de très généreuses exonérations fiscales pour les investissements dans le secteur de la haute technologie.

On peut s'interroger sur la rationalité économique de ces courses aux subventions tant au niveau des pays ou des régions qui accordent ces subventions, qu'à un niveau plus général.

Au niveau des pays ou des régions, l'enjeu des courses aux subventions étant surtout d'attirer l'investissement étranger (mais pas uniquement, comme le montre l'exemple de Tata Motors), la question qu'il convient de se poser est celle de savoir si l'investissement étranger génère suffisamment d'externalités pour justifier l'octroi de subventions. On a des raisons de penser que l'investissement direct étranger a des effets positifs pour les autres entreprises du même secteur ou les entreprises qui lui sont liées verticalement (en amont ou en aval). Ces raisons sont, pour l'instant, plus nombreuses dans le cas des pays développés. Dans le cas de pays en développement ou en transition, on dispose aussi d'un ensemble d'observations (encore limité, certes) qui montre que la présence de sociétés affiliées à des entreprises étrangères a tendance à améliorer la productivité de leurs fournisseurs locaux, mais il a aussi été constaté que ces effets varient beaucoup d'un cas à l'autre.³⁹

Ces observations impliquent que l'octroi d'importantes subventions par un pays ou une région pour attirer l'investissement étranger peut être rationnel. Il risque, toutefois, de ne pas l'être collectivement du fait qu'on est alors en présence d'un « dilemme du prisonnier ». En fin de compte, la plupart des

³⁸ Cet exemple et ceux qui suivent sont tirés de l'étude d'Andrew Charlton diffusée en 2003 sous le titre: « Incentive Bidding for Mobile Investment : Economic Consequences and Potential Responses », Centre de développement de l'OCDE, document de travail n° 203.

³⁹ B. Javorcik, 2004, « Does Foreign Direct Investment Increase the Productivity of Domestic Firms? In Search of Spillovers Through Backward Linkages », *American Economic Review*, 2004, vol. 94(3).

investissements bénéficiant de subventions auraient de toute façon été effectués de sorte que les courses aux subventions ont principalement pour effet de gaspiller les deniers publics.

2.3 Les subventions stratégiques dans des secteurs oligopolistiques: surcapacités et introduction de concurrence

Sur un marché oligopolistique, une aide d'État peut aussi générer des externalités internationales en influant sur les décisions d'investissement des concurrents de celui à qui elle bénéficie. Le mécanisme sous-jacent à l'œuvre, qui a été étudié dans les modèles économiques de politiques commerciales stratégiques,⁴⁰ peut être résumé comme suit. Dans un oligopole, dans lequel les entreprises peuvent tirer des rentes de leur pouvoir de marché, le profit d'une entreprise augmente si ses concurrents réduisent leur investissement (compris au sens large, c'est-à-dire incluant la R-D, la publicité, les coûts d'installation dans un nouveau pays, etc.). Le gouvernement d'un pays peut donc avoir intérêt à inciter les concurrents étrangers de l'un de ses champions nationaux à revoir en baisse leurs investissements.⁴¹ L'aide publique peut permettre d'obtenir ce résultat dans certains cas. Par exemple, si le pays A accorde une aide à l'investissement à une entreprise, ses concurrents dans le pays B peuvent s'attendre à une expansion du bénéficiaire de l'aide et donc à une réduction de la demande résiduelle à laquelle ils font face. Ils peuvent, de ce fait, être incités à réduire leur investissement. Tout cela se solde par le transfert d'une partie des rentes de l'oligopole vers le bénéficiaire de l'aide au détriment de ses concurrents.⁴²

L'octroi de l'aide peut donc permettre à son bénéficiaire d'accaparer une partie de la demande qui, sans cette aide, aurait été satisfaite par des concurrents étrangers. Ce mécanisme implique une externalité négative entre les pays du fait que quand un pays accorde une aide, il ne tient pas compte du préjudice qu'il cause aux concurrents étrangers.

Cette logique opère probablement dans des secteurs comme celui de l'automobile. Comme on l'a rappelé plus haut, les gouvernements de tous les pays, qu'ils soient développés ou en développement, ont accordé des subventions massives à leur industrie automobile, le total de leurs engagements étant évalué à 48 milliards USD en 2008. Beaucoup de gouvernements justifient l'octroi d'une aide par la nécessité de rétablir l'équilibre concurrentiel et de compenser les subventions consenties par les gouvernements étrangers.

Théoriquement, l'effet que ces subventions ont sur le bien-être social est ambigu puisqu'elles peuvent générer une externalité positive entre les pays: si le bénéficiaire de l'aide accroît sa production ou ses investissements, cela peut être bénéfique pour les consommateurs non seulement du pays qui a octroyé l'aide, mais aussi des pays étrangers. Un gouvernement qui se préoccuperait uniquement du bien-être des agents économiques nationaux ne tiendrait pas compte de cet effet. Si cette externalité positive était plus importante que l'externalité négative mentionnée plus haut (celle affectant les producteurs étrangers), il se pourrait que, même en l'absence de contrôle des aides publiques, l'aide accordée par les gouvernements soit insuffisante plutôt qu'excessive!⁴³

⁴⁰ J. Brander et B. Spencer, 1985, « Export Subsidies and International Market Share Rivalry », *Journal of International Economics*, vol. 18, p. 83.

⁴¹ Voir Forum mondial sur la concurrence 2009, Table ronde sur la politique de la concurrence, la politique industrielle et les champions nationaux (voir plus haut la note 6 de bas de page).

⁴² Dans certaines circonstances, le lien de cause à effet peut être inversé. Par exemple, une entreprise devant faire face à une diminution de sa demande résiduelle peut être davantage incitée à investir dans la R-D pour améliorer sa position sur le marché.

⁴³ D. Collie, 1998, « State aid in the European Union: The prohibition of subsidies in an integrated market », *International Journal of Industrial Organization*, vol.18, pp. 867-884; D. Collie, 2002, « Prohibiting State

Abstraction faite de toute considération théorique, il est évident que ce type de subventions stratégiques est très coûteux pour l'économie mondiale, au moins dans le secteur automobile, du fait qu'il compromet l'équilibre tout à fait nécessaire entre les capacités de production et la demande globale.

Ce résultat n'est toutefois pas universel. Dans certains cas, surtout quand la subvention sert à instaurer un nouveau concurrent sur un marché où la concurrence fait défaut, elle peut améliorer le bien-être. L'externalité positive en jeu est l'effet sur le degré de concurrence. Par exemple, la création d'Airbus a eu des effets positifs non seulement sous la forme des bénéfices tirés de la vente des appareils, mais aussi de la baisse des prix (compte tenu de la qualité) des appareils de Boeing qui a transféré aux compagnies aériennes du monde entier (et à leurs clients) les rentes de monopole dont jouissaient les actionnaires américains. Il en va de même chose pour la création d'Embraer, le constructeur aéronautique brésilien. La principale conclusion à laquelle aboutissent les travaux de recherche empirique est que l'effet des subventions destinées à instaurer la concurrence est très complexe et pluridimensionnel. Il a, par exemple, été estimé que du fait de l'intensification de la concurrence dans le secteur aéronautique que la création d'Airbus a favorisée, les subventions correspondantes ont notablement amélioré le bien-être en Europe, mais diminué l'excédent économique mondial (une fois prises en compte les pertes subies par les constructeurs aéronautiques en place).⁴⁴

2.4 Les distorsions provoquées par les subventions

La principale raison pour laquelle les subventions sont une source d'inefficience, en dehors du gaspillage qu'elles peuvent constituer (auquel cas l'inefficience découle du coût d'opportunité des fonds publics), est qu'elles altèrent les signaux du marché. Cela peut se traduire par deux types d'inefficience. *Les inefficiences allocatives* qui se produisent quand les quantités relatives produites et consommées de divers biens ne sont pas optimales et les *inefficiences techniques* que l'on observe quand, pour un niveau donné de production, les intrants nécessaires ne sont pas utilisés d'une façon permettant de réduire les coûts au minimum (y compris ceux pour l'environnement).

Cette interférence avec les signaux du marché peut revêtir deux principales formes. Lorsque les aides publiques représentent une subvention générale couvrant tous les intrants, l'inefficience résulte de l'écart entre les prix perçus par les agents économiques, qui sont affectés par la subvention, et les « vrais » prix, reposant sur les coûts.

Lorsque les aides publiques ciblent des entreprises particulières, elles modifient le mécanisme « darwinien » par lequel le capital est alloué aux entreprises les plus efficaces et qui a tendance à réduire au minimum les coûts totaux de production. Cet effet peut jouer à la fois au niveau intrasectoriel et au niveau intersectoriel. Dans le premier cas, les aides publiques peuvent diriger le capital et le travail vers des entreprises moins efficaces et générer ainsi des inefficiences productives. Dans le second, elles peuvent affecter la taille relative des divers secteurs et entraîner une surproduction dans les secteurs subventionnés et une sous-production dans d'autres.

Ces divers mécanismes sont mis en évidence ci-après à l'aide de quelques exemples. À des fins d'illustration, nous nous focalisons sur des exemples tirés de pays en développement et sur des distorsions ayant un impact sur l'environnement. Nous considérons aussi quelques exemples fournis par la crise financière récente et le renflouement des banques.

aid in an Integrated Market', *Journal of Industry, Competition and Trade*, vol. 2 (3), p. 215; D. Collie, 2005, « State aid to Investment and R&D », *European Economy, Economic Papers*, vol. 231, p. 1.

⁴⁴ D. Neven et P. Seabright, 1995, « European Industrial Policy: the Airbus Case », *Economic Policy*, vol. 21, pp. 313-358.

2.4.1 Distorsion des prix

L'exemple le plus frappant de distorsions coûteuses pour l'économie et l'environnement, créées par des subventions, nous est fourni par les subventions à l'énergie.

Ces subventions sont quantitativement importantes tant du côté de la consommation que de celui de la production, dans les pays en développement comme dans les pays développés. Les subventions de l'Iran aux combustibles s'élèvent à environ 55 milliards USD par an. Celles de l'Inde ont été estimées à un montant annuel d'au moins 15 milliards USD qui bénéficie à l'agriculture à hauteur de 90%. Il est assez intéressant de noter que ce sont les gros producteurs et exportateurs de combustibles fossiles qui ont le plus tendance à subventionner fortement la consommation d'énergie: en dehors du cas extrême de l'Iran, l'Arabie saoudite et le Venezuela, deux des plus gros producteurs mondiaux de pétrole, figurent aussi parmi les pays qui subventionnent le plus la consommation intérieure d'énergie (à hauteur de 26 et 17 milliards USD par an, respectivement)⁴⁵. La raison en est probablement que les gouvernements concernés considèrent comme presque négligeable le coût de ces subventions. Celles-ci sont coûteuses quand le prix du marché du pétrole est élevé qui est aussi le moment où ces gouvernements tirent des recettes importantes des exportations pétrolières.

Même dans l'Union européenne, malgré l'existence de stricts mécanismes de contrôle des aides publiques, certains combustibles fossiles bénéficient de très importantes subventions à la production. Au cours de la décennie 1994-2005 des aides d'État en faveur de l'industrie charbonnière ont été approuvées pour un montant de plus de 80 milliards EUR. En Allemagne, les subventions d'exploitation équivalaient, en 2004, à plus de 86 EUR la tonne, ce qui laisse supposer que le coût de production du charbon y était plus de deux fois supérieur au prix du marché mondial. Du côté de la consommation, la persistance, en France, d'un dispositif complexe de réglementation des prix ayant pour effet de maintenir le prix de l'électricité en dessous du coût marginal réel de sa production, offre un autre exemple de brouillage des signaux que donnent les prix.⁴⁶

Ce type de subvention crée des distorsions considérables. Du côté de la consommation, l'élasticité à long terme de la demande d'essence a été estimée à environ -0,7, c'est-à-dire qu'une baisse de 1% du prix de l'essence entraîne, à long terme, une augmentation de la demande de 0,7%.⁴⁷ Ce chiffre relativement élevé (en valeur absolue) implique que les subventions susmentionnées ont une incidence non négligeable sur la consommation de pétrole. D'un point de vue purement économique, elles ont tendance à décourager les efforts de conservation et à inciter les agents économiques à agir sans tenir compte des coûts marginaux réels de production des combustibles fossiles. Elles sont aussi préjudiciables à l'environnement du fait qu'elles contrecarrent les efforts de limitation des émissions.

Le cas des subventions énergétiques accordées aux agriculteurs indiens est particulièrement intéressant. La fourniture, depuis les années 70, d'énergie électrique à bas prix aux agriculteurs (qui constituaient, et constituent encore, la majorité de la population et sont extrêmement pauvres) était destinée à leur venir en aide et à les encourager à acheter et à utiliser des pompes pour irriguer leurs cultures. Du fait de cette subvention, les décisions prises en matière de production, même si elles étaient individuellement rationnelles, ont souvent été en fait destructrices de valeur sur la base des coûts réels de la production d'électricité. Cette politique a aussi été préjudiciable à l'environnement. Le coût du pompage

⁴⁵ Agence internationale de l'énergie, 2008.

⁴⁶ D. Spector, 2007, *Electricité: Faut-il désespérer du marché ?*, Editions Rue d'Ulm.

⁴⁷ J. Hamilton, 2008, « Understanding Crude Oil Prices », NBER Working Paper #14492.

de l'eau étant artificiellement réduit, beaucoup d'agriculteurs ont cultivé des plantes consommant beaucoup d'eau, ce qui a eu pour effet d'épuiser les ressources en eau et d'aggraver la salinisation.⁴⁸

Le cas des subventions européennes au charbon illustre les divers biais par lesquels les subventions peuvent être génératrices de distorsions. En principe, le niveau de ces subventions était calculé de manière à ne pas modifier l'« ordre de mérite » des différents types de combustibles, c'est-à-dire à ne pas rendre artificiellement les centrales au charbon plus économiques, disons que celles à gaz. C'est notamment en raison de cette restriction que la Commission européenne a accepté le programme de subventions. Toutefois, même sans elle, ce programme était voué à générer des distorsions du fait qu'il revenait à augmenter l'offre mondiale de charbon, c'est-à-dire à mettre sur le marché mondial une quantité artificiellement gonflée de charbon européen, provoquant ainsi une diminution du prix d'équilibre du marché et par là même, le remplacement d'autres sources d'énergie par le charbon.

L'eau est probablement après l'énergie, le produit de base qui est le plus subventionné dans le monde. On estime à environ 45 milliards USD par an les subventions dont elle bénéficie uniquement dans les pays en développement, ce qui se solde par une surconsommation et des investissements insuffisants dans les réseaux d'acheminement (pour réduire les fuites).

2.4.2 *Inefficiences provoquées au niveau de la production et de l'environnement par une mauvaise affectation du capital*

Une autre source importante d'inefficiences se trouve dans l'octroi sélectif de subventions à certaines entreprises et en particulier à des entreprises publiques. Ces subventions sont une source d'inefficiences parce que si elles sont destinées à des entreprises qui manquent d'efficacité, elles déplacent la production vers les unités moins efficaces et augmentent ainsi les coûts totaux de production. Cela peut aussi entraîner des coûts importants pour l'environnement du fait que les entreprises inefficaces ont tendance à utiliser plus d'intrants par unité de production et sont, de ce fait, plus polluantes.

L'ordre de grandeur des subventions accordées aux entreprises publiques est considérable. Le fait que, dans certains pays, la quasi-totalité des subventions bénéficiait à des entreprises non rentables corrobore l'idée que ces aides n'étaient souvent pas octroyées sur la base d'un calcul coûts/avantages ou du fait de l'existence de déficiences du marché qui devaient être corrigées, mais uniquement pour maintenir à flot des unités de production inefficaces.

En dehors des aides gouvernementales directes, les entreprises publiques bénéficient aussi souvent d'un accès préférentiel au crédit accordé par des banques publiques.⁴⁹ Ces subventions directes et indirectes orientent les ressources vers des unités de production inefficaces, ce qui implique une perte sèche qui peut représenter un pourcentage non négligeable de la production industrielle.⁵⁰ L'estimation donnée dans l'étude précédemment citée est frappante parce qu'elle correspond à une moyenne calculée pour l'ensemble des entreprises publiques, dont certaines sont très efficaces, surtout après les réformes dont elles ont fait l'objet de la part des autorités chinoises qui les ont soumises à des règles de gouvernance comparables à celles appliquées dans le secteur privé.

⁴⁸ R. Tongia, 2007, « The Political Economy of Power Sector Reform in India », in *The Political Economy and Institutions of Power Sector Reform in the Developing World*, Victor, D. et Heller, T. (dir. pub.), Cambridge University Press, Cambridge.

⁴⁹ L. Brandt et Z. Zhu, 2000, « Redistribution in a Decentralized Economy: Growth and Inflation in China Under Reform », *Journal of Political Economy*, vol. 108, pp.422–439.

⁵⁰ S. Claro, 2005, « How Uncompetitive is the State-Owned Industrial Sector in China », Documento de Trabajo n° 305, Pontificia Universidad Católica de Chile, Instituto de Economía.

Outre cette perte sèche de nature purement économique, l'octroi de subventions à des entreprises publiques qui ne sont pas efficaces entraîne des coûts non négligeables pour l'environnement. Toute une série de nouveaux travaux empiriques aboutit à la conclusion que les entreprises publiques respectent en général moins l'environnement que les entreprises privées. Certaines études⁵¹ constatent que les premières peuvent émettre jusqu'à dix fois plus de polluants que les secondes, toutes choses égales par ailleurs. Cela semble tenir notamment au fait que les entreprises publiques sont moins surveillées que les entreprises privées pour le respect de l'environnement⁵². Mais cela s'explique aussi probablement par le fait que les subventions permettent de maintenir en activité des unités de production inefficaces qui utilisent en général davantage d'intrants pour un niveau donné de production et sont, en conséquence, également plus polluantes.

L'aide accordée récemment aux institutions financières par beaucoup de gouvernements dans le monde peut aussi avoir d'autres effets moins qu'optimaux. Ce soutien public a surtout bénéficié aux grandes banques, jugées essentielles pour assurer la stabilité du système. Celles-ci ont, de ce fait, eu plus facilement accès au crédit que les plus petits établissements, les créanciers estimant qu'elles bénéficiaient d'une garantie implicite des gouvernements. D'après une estimation récente, les banques dont les avoirs excèdent 100 milliards USD empruntent à des taux inférieurs de 0,34 point à ceux appliqués aux autres banques. Cela peut provoquer une contraction du secteur et renforcer encore la position des grandes banques au détriment de leurs concurrentes de plus petite taille. Il en résulte un manque d'efficacité et c'est la taille même des plus grands établissements et l'idée qu'ils étaient « trop importants pour qu'on les laisse faire faillite » qui ont contribué au déclenchement de la crise financière.⁵³

Dans les pays développés, le soutien des entreprises non rentables est moins répandu, mais il peut parfois être non négligeable lorsque les gouvernements viennent en aide aux « champions nationaux ». Par exemple, dans leur communication à la table ronde 2009 du Comité de la concurrence de l'OCDE sur les marchés financiers⁵⁴, les autorités antitrust des États-Unis citent les garanties d'emprunt accordées par le gouvernement à la Chrysler Corporation en 1980 comme un autre exemple de vaine tentative de sauvetage qui a peut-être eu des conséquences négatives pour la concurrence. D'après ce document américain, si Chrysler avait fait faillite, ses éléments d'actif auraient pu être transférés à un concurrent plus efficace, ce qui aurait pu améliorer la situation concurrentielle du secteur.⁵⁵ De même, d'après William Kovacic, commissaire de la Federal Trade Commission (FTC), la fourniture d'une assistance financière au constructeur aéronautique Lockheed, lorsqu'il était en difficulté au début des années 70, a généré d'importantes inefficacités au niveau de la production. Si on avait laissé Lockheed tomber en faillite, ses

⁵¹ Voir, par exemple H. Wang et Y. Jin, 2002, « Industrial Ownership and Environmental Performance: Evidence from China », document de synthèse 2936, document de travail de la Banque mondiale consacré à la recherche sur les politiques; S. Pargal et D. Wheeler, 1996, « Informal Regulation of Industrial Pollution in Developing Countries: Evidence from Indonesia », *Journal of Political Economy*, vol. 104, pp.1314–1327.

⁵² S. Gupta et S. Saksena, 2002, « Enforcement of Pollution Control Laws and Firm Level Compliance: A Study of Punjab, India », document présenté au deuxième congrès mondial des économistes de l'environnement et des ressources naturelles, Monterey, Californie; H. Wang, N. Mamingi, B. Laplante, et S. Dasgupta, 2002, « Incomplete Enforcement of Pollution Regulation: Bargaining Power of Chinese Factories », document de travail de la Banque mondiale.

⁵³ D. Cho, « Banks 'Too Big to Fail' Have Grown Even Bigger », *Washington Post*, 28 août 2009.

⁵⁴ Concurrence et marchés financiers, OCDE 2009: <http://www.oecd.org/dataoecd/51/14/43139348.pdf>

⁵⁵ Note des États-Unis, Table ronde du Comité de la concurrence de l'OCDE sur la concurrence et les marchés financiers, DAF/COMP(2009)11ADD1, disponible en anglais aux pages 225 à 229, consultables en utilisant le lien suivant: <http://www.oecd.org/dataoecd/45/16/43046091.pdf>. Ce document cite aussi l'aide fédérale accordée à Penn Central comme un autre exemple d'échec de l'aide publique (p. 228, note 10).

éléments d'actif seraient allés à McDonnell Douglas, constructeur alors plus efficace, qui a produit le MD10. Le paysage d'aujourd'hui aurait pu s'en trouver considérablement modifié, d'après le Commissaire Kovacic, le marché comptant dans ce cas au moins trois grands constructeurs efficaces d'appareils long-courriers: Boeing, Airbus et McDonnell Douglas.⁵⁶

2.5 *Les autres coûts des subventions: la faible contrainte budgétaire et le coût de la recherche de rente*

Les aides publiques peuvent aussi avoir des effets négatifs sur l'efficacité économique par le biais de deux autres mécanismes. Le premier est celui dit de la « faible contrainte budgétaire ». La particularité frappante de ce mécanisme est que la source de l'inefficacité n'est pas l'octroi de subventions lui-même, mais plutôt l'attente d'un renflouement possible des entreprises défaillantes et des subventions qui pourraient leur être accordées. S'il semble probable que les pouvoirs publics viendront au secours de celles qui défailtront, les entreprises peuvent être encouragées à procéder à des investissements risqués ou à manquer de rigueur dans leur gestion. D'une manière plus générale, une entreprise sera moins incitée à devenir plus efficace pour réduire ses coûts, améliorer la qualité de sa production ou innover si elle s'attend à ce que l'avantage concurrentiel ainsi obtenu soit neutralisé par l'octroi d'une aide à ses concurrents plus négligents. Cette idée a été formulée par l'économiste Janos Kornai lorsqu'il a analysé les tentatives de libéralisation économique partielle des autorités hongroises: « *Les entreprises publiques avaient certes un intérêt moral et financier à maximiser leurs profits, mais on ne laissait jamais tomber en faillite celles qui étaient chroniquement déficitaires. Elles étaient toujours renflouées par des aides financières ou d'autres moyens. Les entreprises étaient assurées de survivre même après des pertes chroniques et cette attente a laissé une marque sur leur comportement* ».⁵⁷

Ce type de mécanisme est difficile à mesurer parce qu'il n'implique pas un lien direct de cause à effet entre une aide donnée et un manque d'efficacité mesurable. Une étude récente des performances des entreprises publiques coréennes corrobore toutefois l'idée que la faible contrainte budgétaire, c'est-à-dire l'attente d'un renflouement par les pouvoirs publics en cas de défaillance, a une forte incidence sur l'efficacité de l'exploitation des entreprises. Cette étude⁵⁸ constate que les entreprises publiques coréennes ont amélioré l'efficacité de leur exploitation et leur rentabilité entre 1998 et 2002, à un moment où elles étaient confrontées à la perspective d'une privatisation du fait d'un engagement pris à cet effet par le gouvernement. Si leur efficacité s'est améliorée ce n'est donc pas en raison de la privatisation (qui n'a, en fait, pas eu lieu pour la plupart des entreprises considérées), mais simplement parce qu'elles ne pouvaient plus espérer être renflouées en cas de défaillance.

Le débat récent sur le renflouement d'Air India offre un autre exemple de ce mécanisme de faible contrainte budgétaire. Le gouvernement a fait savoir que c'était « la première et la dernière fois » qu'il renflouerait la compagnie aérienne. Comme dans n'importe quelle situation de ce type, rendre cet engagement crédible constituait un aspect important de la stratégie d'ensemble visant à obliger les gérants de la compagnie à prendre des décisions difficiles, mais nécessaires, comme celle de réduire les effectifs.

⁵⁶ W. Kovacic, participant à l' « Industrial Policy and Competition Law and Policy Roundtable » (« Industrial Policy Roundtable »), 2006 Fordham Comp. L. Inst. 239-40 (B. Hawk dir. pub. 2007).

⁵⁷ J. Kornai, E. Maskin et G. Roland, 2003, « Understanding the Soft Budget Constraint », *Journal of Economic Literature*, vol. 41 (4), p. 1095. Voir aussi J. Kornai, 1986, « The Soft Budget Constraint », *Kyklos*, vol. 39 (1), p. 3.

⁵⁸ J. Kim et H. Chung, 2008, « Empirical Study on the Performance of State-owned –enterprises and the Privatizing Pressure : The Case of Korea », document présenté à la conférence d'Utrecht sur la « réglementation » à la suite du néolibéralisme. Les conséquences de trois décennies de privatisation et de libéralisation des marchés, consultable à l'aide du lien: <http://regulation.upf.edu/utrecht-08-papers/jkim.pdf>.

Les observateurs extérieurs n'ont toutefois pas jugé cet engagement crédible du fait notamment que la compagnie Air India constituait, comme la plupart des transporteurs nationaux, un symbole trop important pour qu'on la laisse faire faillite, mais surtout parce que c'était une entreprise publique.⁵⁹ On peut trouver des exemples du même ordre dans de nombreux pays, y compris en Europe.

Dans un certain sens, la crise financière de 2008 constitue un exemple extrême du dommage causé par l'existence d'une faible contrainte budgétaire. Un facteur qui a contribué à une prise de risque excessive par les banques a été la garantie implicite des pouvoirs publics dont elles pensaient jouir (et dont elles jouissaient effectivement comme l'ont montré les coûteux plans de sauvetage adoptés en leur faveur). Là encore, le dommage causé par la prise de risque excessive n'a pas tenu à l'octroi de l'aide, mais à l'attente de cet octroi en cas de besoin. Cette remarque ne doit pas être interprétée comme signifiant que les plans de sauvetage des banques étaient inopportuns; même si on peut en contester certains détails, peu d'économistes nient le besoin d'une intervention gouvernementale. Cette observation met cependant en évidence les coûts économiques, peut-être importants, de l'attente d'une aide publique.

Il est frappant de constater que tous ces effets négatifs ont en commun de ne pas être provoqués par les subventions elles-mêmes, mais plutôt par l'attente de leur octroi possible à l'avenir. Ils ne peuvent donc pas être expliqués individuellement lorsqu'on évalue les avantages et les inconvénients d'une subvention donnée.

2.6 *Les mécanismes politiques à l'œuvre derrière les subventions inefficaces*

Les mécanismes précédemment décrits qui peuvent conduire à l'octroi de subventions inefficaces se répartissent entre deux grandes catégories: les externalités négatives entre juridictions et la propension intrinsèque des administrations à prendre des décisions inefficaces. Si les courses stériles aux subventions et la concurrence pour l'obtention de rentes sur des marchés oligopolistiques qui conduisent à un excès de capacités de production au niveau mondial peuvent s'expliquer par la présence d'externalités négatives entre des administrations (locales, régionales ou nationales) rationnelles cherchant à maximiser le bien-être, beaucoup d'autres mécanismes sont à l'œuvre qui expliquent pourquoi les administrations ont tendance à accorder des subventions qui n'ont guère de justification économique même de leur point de vue limité.

On peut trouver de nombreux exemples de subventions dont l'octroi ne se justifiait pas à l'évidence du point de vue de l'intérêt collectif, mais s'explique davantage par la recherche de rentes ou des motivations politiques: un cas extrême est celui de l'aide accordée, dans les années 90, par l'État du Michigan à diverses entreprises en vue de créer des emplois pour un coût de plus de 2 millions USD par emploi.⁶⁰ D'une manière plus générale, la capacité des groupes d'intérêt privés d'influencer la politique économique en leur faveur au détriment d'autres a fait l'objet de nombreuses publications,⁶¹ tout comme l'incidence des liens politiques sur les résultats des entreprises, tant dans les pays développés que dans les pays en développement.⁶² Par exemple, d'après des études existantes, le degré de protection douanière dont

⁶⁰ Voir R. Tannenwald, 2002, « Are State and Local Revenue Systems becoming Obsolete? », *National Tax Journal*, vol. 55 (2), septembre, p. 467.

⁶¹ T. Persson et G. Tabellini, 2000, *Political Economics: Explaining Economic Policy*, MIT Press.

⁶² B. Roberts, 1990, « A Dead Senator Tells No Lies: Seniority and the Distribution of Federal Benefits », *American Journal of Political Science*, vol. 34 (1), pp. 31–58 ; R. Fisman, 2001, « Estimating the Value of Political Connections », *American Economic Review*.

bénéficient diverses industries aux États-Unis est directement lié au niveau des dons aux partis politiques.⁶³ Il est aussi manifeste que la politique publique visant un secteur ou une entreprise en particulier (comme la politique commerciale) favorise en général des activités en déclin. C'est une situation que l'on constate très fréquemment. On peut l'observer aussi bien dans la politique commerciale des États-Unis⁶⁴ que dans la politique européenne en matière d'aides publiques: par exemple, de nombreux pays européens ont dépensé des milliards d'euros pour essayer de maintenir à flot leurs mines de charbon inefficaces avec pour seul résultat de retarder leur fermeture de quelques années.

Une étude économétrique des aides publiques en Europe⁶⁵ conclut que plus le système politique d'un pays rend politiquement rentables les aides ciblées (par exemple, pays où les circonscriptions électorales sont peu étendues, l'écart idéologique entre les partis est faible et l'unité au sein de chacun d'eux est limitée), plus la part de ces aides aux entreprises (aides « sectorielles » dans la terminologie de l'UE) est élevée par rapport aux aides « horizontales ». Cela laisse supposer que l'octroi d'une aide à des secteurs spécifiques repose, jusqu'à un certain point, sur des considérations électorales, malgré le contrôle strict exercé par la Commission européenne.

Ces constatations impliquent deux choses. Premièrement, la recherche de rentes et les décisions à motivation politique peuvent affecter la nature et la destination des subventions, ce qui se solde souvent par une utilisation inefficace des fonds publics et par des inefficacités au niveau de la production et de l'affectation des ressources. En outre, plus l'octroi des subventions se prête à une captation par des intérêts privés, plus les entreprises risquent d'investir dans des activités de recherche de rentes, ce qui représente un gaspillage de ressources, le coût de ces activités étant très élevé d'après plusieurs estimations.⁶⁶

La façon dont la crise financière récente a été gérée illustre bien notre propos. Certains observateurs estiment que le plan de renflouement adopté par les États-Unis était plus favorable aux actionnaires des banques qu'un plan potentiellement plus efficace qui aurait impliqué la nationalisation de banques insolubles.⁶⁷ De même, une analyse du vote, en octobre 2008, par les membres du Congrès des États-Unis, de la loi de stabilisation économique d'urgence (« EESA ») qui, d'après les auteurs de l'analyse, « effectue un transfert de richesse des contribuables vers le secteur des services financiers » révèle que « la

⁶³ P. Goldberg et G. Maggi, 1999, « Protection for Sale: An Empirical Investigation », *American Economic Review*, vol. 89 (5), p. 1135.

⁶⁴ G. Hufbauer et H. Rosen, 1986, « Trade Policy for Troubled Industries », *Policy Analyses in International Economics* 15, Institute for International Economics, Washington, D.C.; G. Hufbauer, Gary, D. Berliner et K. Elliot, 1986, « Trade Protection in the United States: 31 Case Studies », Institute for International Economics, Washington, D.C. ; E. Ray, 1991, « Protection of manufactures in the US », in D. Green, *Global Protectionism: Is the US playing on a level field?* Macmillan, Londres.

⁶⁵ U. Aydin, 2007, « Politics of state aid in the European Union: Subsidies as Distributive Politics », Université de Washington, Département des sciences politiques, document non publié.

⁶⁶ Aux États-Unis, le total des dépenses consacrées aux activités de transfert a été estimé à 25% du PIB (D. Laband et J. Sophocleus, 1992, « An Estimate of Expenditures on Transfer Activity in the United States », *Quarterly Journal of Economics*, vol. 107(3), pp. 959-983). D'autres estimations, reposant sur des régressions du produit national brut par rapport au nombre relatif d'avocats (indicateur de l'ampleur des activités de recherche de rentes) et de médecins ou d'ingénieurs (indicateur du volume des activités productrices) font apparaître un coût similaire, voire plus élevé, pour les activités de recherche de rentes (S. Magee, W. Brock et L. Young, 1989, *Black Hole Tariffs and Endogenous Policy Theory: Political Economy in General Equilibrium*, Cambridge University Press; K. Murphy, A. Shleifer et R. Vishny, 1991, « The Allocation of Talent: Implications for Growth », *Quarterly Journal of Economics*, vol. 106(2), pp.503-530.)

⁶⁷ M. Richardson et N. Roubini, « Nationalize the Banks! We're all Swedes Now », *Washington Post*, 15 février 2009.

probabilité d'un vote en faveur de l'EESA augmente avec l'importance des contributions du secteur des services financiers aux campagnes électorales ». ⁶⁸

Les subventions créent parfois de nouveaux intérêts qui se livrent à des activités de recherche de rentes en s'efforçant, par exemple, d'obtenir la perpétuation de mesures de politique industrielle auxquelles il faudrait en fait mettre fin parce que les circonstances se sont modifiées. Le projet Concorde, financé par le Royaume-Uni et la France, illustre ce point. ⁶⁹ Le lancement d'un avion supersonique se justifiait dans les années 60 lorsque le pétrole était bon marché, mais il n'avait plus de justification économique après le choc pétrolier de 1973. Le projet se trouvant toutefois déjà à un stade avancé, le groupe constitué par les nombreux fonctionnaires et hommes d'affaires qui étaient parties prenantes, avait tout intérêt à ce qu'il ne soit pas abandonné. Ce groupe l'a finalement emporté sur les signaux du marché et le projet a été poursuivi pour un coût considérable pour les deux pays.

Ce type de lien de causalité préjudiciable peut être observé dans diverses situations. Contrastant avec l'exemple du projet de haute technologie qu'a constitué le projet Concorde, la politique suivie par de nombreux États indiens qui ont subventionné l'électricité pour les agriculteurs afin de favoriser le pompage de l'eau et l'irrigation a eu un effet de verrouillage. L'électricité leur étant fournie à bas prix, de nombreux agriculteurs ont acheté des pompes et investi leur savoir-faire dans la culture de plantes ayant besoin de beaucoup d'eau. Cet investissement financier et humain a renforcé la demande d'électricité bon marché: l'idée est essentiellement que si l'on subventionne un bien (dans ce cas, l'électricité), celui à qui cela bénéficie est incité à investir dans un bien complémentaire (dans ce cas, les pompes électriques et le savoir-faire pour la culture de plantes consommant beaucoup d'eau), ce qui augmente la demande pour la subvention initiale. En fin de compte, la pression politique exercée pour que l'électricité continue d'être subventionnée est devenue la principale raison pour laquelle la mesure a été maintenue, bien après que les politiciens eurent pris conscience de son caractère pernicieux.

Les importantes subventions dont bénéficie l'agriculture dans beaucoup de pays nous offrent d'autres exemples à cet égard. Prenons celui de la politique agricole commune établie par l'Union européenne, au départ, pour favoriser l'efficacité au moins de deux façons. Premièrement, elle devait encourager les agriculteurs européens à adopter des technologies plus efficaces, ce qui impliquait, dans certains cas, de procéder à des ajustements très difficiles, comme l'échange de parcelles de terrain entre agriculteurs pour que la configuration des exploitations se prête à l'utilisation des nouvelles techniques. Deuxièmement, elle devait permettre à l'Europe de couvrir ses besoins alimentaires, ce qui, dans les années 60, constituait un objectif valable puisque dans le contexte de la guerre froide, la notion de « sécurité alimentaire » avait un sens. Dans les années 90, toutefois, toutes ces justifications n'avaient pratiquement plus de raison d'être. On aurait pu penser qu'il serait facile de réduire le montant des subventions à l'agriculture, mais cela n'a pas été le cas parce que leurs bénéficiaires s'étaient mués en un groupe politique puissant. De même, les subventions visant à augmenter la production d'éthanol aux États-Unis, qui devaient permettre au départ de développer un produit susceptible de remplacer les combustibles fossiles, ont perdu leur justification économique quand, en 2007 et 2008, le prix du blé et de la canne à sucre (utilisés dans la production d'éthanol) a commencé à augmenter. De fortes pressions ont alors été exercées en faveur du maintien du statu quo du fait notamment que les subventions à l'éthanol avaient été capitalisées dans les prix des terrains, ce qui rendait difficile un changement de politique.

Une étude récente des décisions d'investissement prises par des fonds souverains confirme que plus les politiciens interviennent dans ces décisions, plus ces fonds servent à subventionner des entreprises

⁶⁸ A. Mian, A. Sufi et F. Trebbi, 2009, « The Political Economy of the U.S. Mortgage Default Crisis », NBER Working Paper # 14468.

⁶⁹ D. Myddleton, 2007, *They Meant Well: Government Project Disasters*, Institute of Economic Affairs Monographs, Hobart Paper n°160.

nationales.⁷⁰ Cette étude constate, en effet, que les fonds qui sont davantage gérés par des politiciens ont tendance à investir plus dans les entreprises nationales (ce qui corrobore l'idée que ces fonds servent à récompenser des amis plutôt qu'à diversifier les avoirs nationaux) et, qui plus est, dans des entreprises à coefficients de capitalisation des résultats élevés qui, en moyenne, valent moins après l'investissement. Cette dernière observation suggère que les fonds souverains dans la gestion desquels les politiciens interviennent davantage ont tendance à subventionner les entreprises dans lesquels ils investissent en leur fournissant des capitaux à des conditions plus favorables que celles permettant d'obtenir des taux de rendement normaux.

La vague récente de renflouements d'entreprises en difficulté à laquelle on a assisté à la suite de la crise financière illustre le fait que les fonds publics ont tendance à être distribués sur la base de critères économiques quelque peu obscurs. Par exemple, en Russie, la banque publique de développement Vneshekonombnak (VEB) a fait connaître, en 2009, son intention de prêter quelque 50 milliards USD à des entreprises en difficulté avec la possibilité de convertir ces prêts en participation de l'État si ces entreprises se révélaient incapables de les rembourser. De nombreux observateurs, y compris en Russie, ont toutefois critiqué le fait que ni le choix des bénéficiaires, ni la nature de l'aide fournie (celle-ci étant notamment accordée sans condition) ne reposait sur des critères objectifs à tel point que certains ont pu affirmer qu'« en Russie, des mesures de renflouement d'un montant de 50 milliards USD bénéficient à ceux qui sont riches et bien introduits »⁷¹. Par exemple, le constructeur automobile Avtovaz a bénéficié, en 2009, d'un prêt sans intérêt de 730 millions USD, d'un prêt de 230 millions USD accordé à un taux favorable par des banques d'État et d'un engagement de banques publiques de l'aider à lever, en outre, 2,6 milliards USD auprès du système bancaire. Aucun engagement ne lui a été demandé, en contrepartie, au niveau de sa gestion qui est généralement considérée comme loin d'être efficiente. L'Union russe des industriels et des entrepreneurs a, en conséquence, demandé que des normes publiques transparentes soient établies pour l'octroi des aides financières, en mettant en garde contre les dangers du favoritisme. Le conseiller financier à l'origine de cette stratégie de renflouement a même critiqué « le gaspillage que constituait l'attribution des fonds à des entreprises inefficaces, bien introduites dans les milieux politiques ».⁷²

Un autre mécanisme conduisant à des subventions inefficaces joue dans les pays qui tirent une large part des recettes publiques de l'exportation de matières premières comme le pétrole. L'opinion publique sachant que l'État engrange des recettes exceptionnelles lorsque les cours mondiaux s'envolent, elle exerce des pressions pour que celles-ci soient redistribuées et les gouvernements estiment souvent que la façon la moins risquée de le faire est de subventionner la matière première à l'origine de ces recettes. La raison en est que ce type de redistribution comporte un « stabilisateur budgétaire » automatique puisque son coût est directement proportionnel aux recettes exceptionnelles. C'est toutefois un mécanisme de redistribution très inefficace du fait qu'il fausse les signaux de prix, comme on l'a expliqué plus haut. Une solution envisageable est de créer des fonds de placement extraterritoriaux, comme ceux établis par la Norvège, le Koweït ou l'Azerbaïdjan, qui permettent aux gouvernements de « se lier les mains ».

D'après Rodrik (1995)⁷³, les subventions accordées aux industries naissantes dans les pays d'Asie de l'Est au cours des dernières décennies ont été relativement à l'abri de comportements de recherche de

⁷⁰ S. Bernstein, J. Lerner, A. Schoar, 2009, « The Investment Strategies of Sovereign Wealth Funds », Harvard Business School Working Paper 09-112.

⁷¹ *New York Times*, 31 octobre 2008.

⁷² A. Kramer, « Russian Auto Bailout Protects Jobs, Not Efficiency », 7 avril 2009; l'ISCIP Analyst, « An Analytical Review », vol. XV (4), 6 novembre 2008, et P. Pan, « Russian élite look to Kremlin for aid as wealth évaporates », *Washington Post*, 17 octobre 2008.

⁷³ D. Rodrik, 1995, « Getting Interventions Right: How South Korea and Taiwan Grew Rich », *Economic Policy*, vol. 10(20).

rentes à la différence de ce qui a été observé dans la plupart des pays en développement et dans de nombreux pays développés. Comme Rodrik (2004)⁷⁴ le précise, l'observation de tels comportements ne permet pas à elle seule de se prononcer contre les subventions ciblées et les politiques industrielles de même que l'existence de ce type de comportement dans le secteur de l'éducation ne justifie pas de renoncer au service public de l'éducation. Ces constatations ne plaident toutefois pas en faveur des politiques qui dotent les gouvernements d'outils leur permettant de favoriser certaines entreprises de façon arbitraire. Des instruments de portée plus générale ou la fourniture, sur une base temporaire, d'une aide ciblée aux nouvelles entreprises et aux nouvelles activités, limiteraient probablement les possibilités de comportements de recherche de rentes.

Les gouvernements ont de bonnes raisons d'accorder des subventions aux entreprises dans certaines circonstances. Ces raisons (qui entrent souvent, mais pas exclusivement, dans le champ de la « politique industrielle ») ne justifient cependant pas la signature d'un chèque en blanc pour les subventions. Comme le montrent les exemples cités plus haut, la dynamique politique peut impliquer qu'une subvention économiquement pertinente au départ crée des intérêts établis qui rendent sa suppression très difficile même lorsqu'elle ne se justifie plus. De plus, comme on le verra ci-après, l'existence de justifications théoriques pour les subventions n'implique pas nécessairement que les gouvernements, même s'ils sont bienveillants et ne cèdent pas aux pressions d'intérêts spéciaux, peuvent facilement déterminer quelles subventions sont « appropriées » et quelles subventions seraient dépensées en pure perte.

3. Les justifications possibles des aides d'État et leurs limites

3.1 *Rapide présentation des justifications les plus fréquemment invoquées pour les aides publiques et les subventions*

La justification la plus fréquemment invoquée pour les aides publiques est qu'elles permettent aux gouvernements de remédier à diverses défaillances des marchés.

Par exemple, les marchés peuvent ne pas réussir à assurer une répartition des revenus jugée équitable ou politiquement souhaitable. En principe, l'outil approprié dans ce type de cas est la politique budgétaire plutôt que l'octroi de subventions. Cependant, dans certaines circonstances, surtout quand les autorités visent à soutenir le revenu d'une catégorie de la population qui est définie par son activité économique (agriculture, par exemple) plutôt que par ses revenus monétaires, elles décident de subventionner directement l'activité économique concernée.

Une autre justification souvent avancée pour l'octroi de subventions à des entreprises privées est la préservation de l'emploi quand les entreprises risquent la faillite ou sont « menacées » d'une prise de contrôle par des intérêts étrangers, jugée susceptible de mettre des emplois en péril.

Toutefois, la justification la plus fréquente des aides publiques et des subventions est la présence d'externalités positives créées par certaines activités, c'est-à-dire l'idée que la valeur sociale de certaines activités excède leur valeur privée. Si l'écart entre ces deux valeurs n'est pas comblé par des subventions, les agents privés ne sont pas suffisamment incités à se lancer dans une activité socialement utile. C'est sur cette idée que reposent les subventions incluses dans une « politique industrielle ».

Nous allons maintenant examiner les divers mécanismes qui peuvent justifier l'octroi de subventions en faisant ressortir les limites et les risques qui lui sont associés, même en présence de justifications objectives, puis nous montrerons comment la nouvelle approche économique mise en œuvre par la Commission européenne évalue les diverses justifications possibles des aides publiques.

⁷⁴ D. Rodrik, 2004, « Industrial Policy for the twenty-first century », Harvard Kennedy School Working Paper 04-047.

3.2 Les subventions et le soutien des revenus

L'imposition et les transferts aux particuliers sont les deux moyens les plus naturels de redistribuer les revenus. Dans certains cas, toutefois, l'action politique de groupes d'intérêts pousse les gouvernements à redistribuer les revenus non pas sur la base de critères monétaires, mais pour d'autres raisons, comme venir en aide aux membres de certaines professions. Le soutien apporté au secteur agricole en est une parfaite illustration. Par exemple, le revenu moyen transféré à un agriculteur moyen en France, par le biais de la politique agricole commune, s'élevait à 17 000 EUR en 1999,⁷⁵ bien que les agriculteurs ne soient, dans l'ensemble, pas plus pauvres que la population moyenne.

Les subventions constituent, dans l'ensemble, une façon inefficace de redistribuer les revenus parce qu'elles génèrent des distorsions de prix. Par exemple, la perte de bien-être provoquée par la politique agricole commune avant sa réforme (lancée en 2004) a été estimée à 0,9% du PIB européen, ce qui est beaucoup étant donné que l'agriculture ne contribue qu'à 2% de ce PIB.⁷⁶

Cet exemple montre que les subventions ne constituent pas une façon efficace de redistribuer les revenus. Elles créent des intérêts établis qui rendent difficile de les supprimer, voire simplement de les ajuster, et elles entraînent des coûts économiques non négligeables.

Un autre inconvénient de recourir aux subventions plutôt qu'à l'imposition directe pour redistribuer les revenus est que les subventions manquent souvent leurs objectifs du fait qu'elles peuvent finalement être accaparées par des agents auxquels elles n'étaient pas destinées. Là encore, l'aide à l'agriculture en est un bon exemple. Le facteur de production pour l'agriculture est la terre, dont l'offre est inélastique, plutôt que le travail. La théorie économique prédit, de ce fait, que les subventions ont plus de chances de se refléter dans le prix des terres agricoles que dans les revenus des ouvriers agricoles. Ce raisonnement a été confirmé par l'expérience: la Nouvelle-Zélande a réduit massivement ses subventions à l'agriculture à partir de 1983, en les divisant par 10. Les revenus des agriculteurs ont, de ce fait, fortement diminué pendant les deux années suivantes. Ils se sont ensuite, toutefois, nettement redressés quand les prix des terres ont fléchi pour finalement retrouver leur niveau initial. Cela souligne le fait que les subventions sont un outil de redistribution difficile à manier.⁷⁷

Pour faire face à ce problème, de nombreux pays, comme les membres de l'Union européenne et les États-Unis, ont décidé de revoir leur politique agricole en abandonnant les subventions à la production au profit d'un soutien direct des revenus sous la forme de transferts forfaitaires dont le montant est calculé en fonction du montant des subventions qui étaient antérieurement perçues dans le cadre du système qui faussait les prix. Ce type d'aide semble moins inefficace en ce sens qu'il est supposé ne pas modifier les décisions de production. C'est la raison pour laquelle les accords de l'OMC (le GATT, alors) ont tendance à considérer favorablement ces subventions (c'est-à-dire que, techniquement, elles sont considérées comme des subventions de la « catégorie verte »). En pratique, toutefois, même ces subventions semblent être à l'origine de certaines distorsions, peut-être parce qu'elles manquent de crédibilité. Les agents ont tendance à penser que l'activité passée donnant le droit à un transfert forfaitaire aujourd'hui, leur activité présente pourra leur donner droit à un transfert à l'avenir. Les études existantes de l'évolution des politiques agricoles dans le monde entier ont, de ce fait, tendance à mettre en garde contre l'idée que les transferts

⁷⁵ P. Messerlin, 2004, « Forging a deal on Agricultural Trade Reform », document présenté à la conférence intitulée: « Breaking the Deadlock in Agricultural Trade and Development », Oxford, juin 2004.

⁷⁶ B. Borrell et L. Hubbard, 2000, « Global Economic Effects of the EU Common Agricultural Policy », *Economic Affairs: Reforming the CAP*, n° 20.

⁷⁷ Gilles Saint-Paul, 2007, « Commentaire », dans P. Chalmin et D. Bureau, « Perspectives agricoles en France et en Europe », Conseil d'analyse économique.

forfaitaires sont une panacée. Ils créent certes moins de distorsions que les subventions directes à la production, mais ils peuvent en créer quand même.⁷⁸

3.3 *Les subventions et les imperfections des marchés du crédit et des capitaux*

Les imperfections du marché du crédit créent fréquemment un écart entre la valeur sociale et la valeur privée des activités économiques. La raison en est que les entreprises susceptibles de se lancer dans des activités productives peuvent être empêchées de le faire parce qu'elles n'ont pas suffisamment accès au crédit du fait d'asymétries au niveau de l'information entre prêteurs et emprunteurs. L'encadrement du crédit est devenu particulièrement rigoureux ces derniers temps sous l'effet de la crise financière. Étant donné que les gouvernements ne savent pas mieux que les banques quelles entreprises méritent de bénéficier d'un crédit, il n'est guère logique qu'ils subventionnent le crédit. Comme la théorie économique classique l'a montré, l'offre privée de crédit peut être inadaptée en cas d'asymétrie de l'information ce qui peut, en principe, justifier de subventionner le crédit même si les pouvoirs publics ne sont pas mieux informés que les prêteurs privés.

Le crédit est souvent directement ou indirectement subventionné dans de nombreux pays et en particulier dans ceux en développement. Par exemple, la législation indienne oblige les banques à consacrer au moins 40% de leurs crédits aux « secteurs prioritaires » qui incluent l'agriculture, la transformation des produits agricoles et la « petite industrie ». Un autre exemple important de crédit subventionné nous est fourni par les établissements de microfinancement des pays en développement qui accordent des prêts de faible montant avec le soutien, souvent, de subventions gouvernementales ou d'organismes d'aide.

Ce qui rend difficile de déterminer la pertinence du recours aux subventions pour pallier l'insuffisance du crédit est le risque que les prêts subventionnés par les pouvoirs publics évincent simplement les prêts privés au lieu d'augmenter le volume total des prêts et d'accroître la production et n'aient donc qu'un effet distributif.

Bien que les situations soient certainement variées, il est permis de penser que les prêts subventionnés ont, dans les pays en développement, un impact sur l'activité économique et l'aptitude des petites entreprises à investir. Une étude récente du programme de prêts orientés vers certains secteurs en Inde constate que le crédit subventionné ne se substitue pas au crédit privé, mais qu'il le complète. Il a, de fait, été observé que lorsque la modification des règles fixées augmentait l'accès de certaines entreprises au programme, le montant total de leur emprunt et le volume global de leur production augmentaient. Si cette étude n'offre pas une analyse coûts-avantages globale, elle montre que les subventions atteignent au moins l'objectif qu'elles visent d'améliorer les perspectives de production des petites entreprises.⁷⁹

⁷⁸ A. Bouet, J.C. Bureau, Y. Decreux et S. Jean, 2004, « Multilateral Trade Liberalisation: The Contrasting Fortunes of Developing Countries in the Doha Round », Discussion Paper n°60, Institute of International Integration Studies, Trinity College, Dublin; E. O'Donoghue et J. Whitaker, 2006, « How distorting are direct payments? », document présenté à la conférence de 2006 de l'American Agricultural Economics Association.

⁷⁹ A. Banerjee et E. Duflo, 2002, « Do Firms Want to Borrow More? Testing Credit Constraints Using a Directed Lending Program », MIT, Department of Economics, document de travail n° 02-25.

De même, une étude des établissements de microfinancement en Afrique du Sud a conclu que la bonification des taux d'intérêt avait un impact sur les taux de recours aux microcrédits des populations ciblées, à savoir les populations pauvres de pays en développement.⁸⁰

L'encadrement du crédit n'est pas la seule forme d'imperfection que peuvent présenter les marchés de capitaux. D'une manière plus générale, ceux-ci peuvent ne pas être en mesure d'offrir des instruments qui permettent aux entreprises de redistribuer leurs risques de manière optimale. L'énergie nucléaire illustre bien l'écart entre la valeur sociale et la valeur privée de certains investissements. L'énergie nucléaire permet aux pays qui ne disposent pas de ressources en combustibles fossiles d'être moins exposés aux fluctuations des cours de ces combustibles. Le fait que le coût de l'électricité d'origine nucléaire est insensible à l'évolution de ces cours constitue, toutefois, un risque pour les entreprises privées puisque les tarifs de l'électricité dépendent principalement des prix des combustibles fossiles (étant donné qu'ils sont déterminés à tout instant par le coût marginal du moyen marginal de production qui est, presque toujours, une centrale thermique classique, même dans les pays à forte capacité de production nucléaire). La rentabilité des investissements dans une centrale nucléaire est donc sensible aux fluctuations des cours des combustibles fossiles à la différence de la rentabilité des investissements dans une centrale thermique classique. Si les marchés de capitaux étaient parfaits, les entreprises investissant dans le nucléaire pourraient émettre des obligations qui seraient indexées sur les cours des combustibles fossiles, et transférer ainsi le risque vers le marché. Des instruments financiers aussi perfectionnés n'existent cependant pas et l'écart entre la valeur sociale d'une limitation de l'exposition à l'instabilité des cours des combustibles fossiles et les incitations privées ne peut être comblé par les seuls mécanismes du marché. Ce raisonnement explique en partie pourquoi le gouvernement américain a décidé de subventionner l'investissement dans la production d'énergie nucléaire dans le cadre de sa loi sur la politique de l'énergie (« Energy Policy Act ») de 2005 en offrant des crédits d'impôt et une assurance contre les retards de construction.

3.4 *Les subventions et les externalités liées aux processus de découverte et d'agglomération*

La concentration d'entreprises actives dans le même secteur, dans une région donnée, est souvent considérée comme génératrice d'externalités locales positives. On peut distinguer trois types de mécanismes à l'œuvre sur la base des études empiriques existantes. Le premier est celui du partage des moyens de production: la concentration d'entreprises d'un même secteur dans une région donnée attire les fournisseurs des intrants nécessaires, ce qui fait baisser les coûts de l'ensemble des entreprises. Le deuxième mécanisme est celui de la création d'un gisement de main-d'œuvre: la concentration d'entreprises attire un vaste gisement de travailleurs dotés des qualifications requises pour le secteur concerné, ce qui permet de réduire les frais de recherche d'emploi pour les travailleurs et de recrutement pour les entreprises. Le troisième mécanisme qui joue est celui de la diffusion des connaissances: l'effort de R-D d'une entreprise peut bénéficier à d'autres entreprises du fait que les nouvelles connaissances qu'elle acquiert se propagent en dehors d'elle par le biais des interactions sociales et commerciales (par exemple, entre fournisseurs et clients) ou sous l'effet des mouvements de personnel entre entreprises. Une variante de cette argumentation, qui concerne plus particulièrement les pays en développement, implique les externalités informationnelles: chaque fois qu'une entreprise s'établit dans un nouveau secteur, d'autres agents observent ses performances et découvrent les possibilités qu'offre ce secteur. D'après Rodrik (2004)⁸¹, ce processus de découverte génère des externalités informationnelles positives et justifie donc une intervention des pouvoirs publics visant à repérer les secteurs prometteurs et à encourager les entreprises à les pénétrer.

⁸⁰ D.S. Karlan et J. Zinman, 2008, « Credit Elasticities in Less-Developed Economies: Implications for Microfinance », *American Economic Review*, vol. 98(3), p. 1040–68.

⁸¹ D. Rodrik, 2004, « Industrial Policy for the twenty-first century », Harvard Kennedy School, Working Paper 04-047.

Les données empiriques mettent deux choses en lumière. D'une part, l'existence d'externalités d'agglomération positives est largement établie, ce qui rend raisonnable la justification théorique de la politique industrielle. D'autre part, les observations recueillies sur les tentatives faites par les pouvoirs publics de reproduire l'expérience de la Silicon Valley ou de faire décoller l'activité dans un nouveau secteur sont contrastées. Beaucoup de ces tentatives ont échoué et plusieurs réussites semblent devoir peu à l'intervention des pouvoirs publics. Dans certains cas, toutefois, surtout dans les pays en développement, cette intervention a joué un rôle essentiel dans le développement réussi de secteurs entièrement nouveaux, comme on le verra plus loin.

L'importance des effets d'agglomération et des économies d'échelle sectorielles a été établie dans une série d'études convergentes. Elle est sans doute assez considérable: par exemple, d'après une étude récente, le doublement de l'échelle régionale d'une industrie se traduit en moyenne, au Japon, par un accroissement de productivité de 4,5%⁸². À la différence des économies d'échelle internes aux entreprises, ces économies d'échelle intrasectorielles justifient théoriquement une intervention publique pour aider les industries à atteindre une échelle suffisante importante. Les divers mécanismes sous-jacents ont également été mesurés. L'hypothèse du partage des intrants a été confirmée par les observations: plus les entreprises sont concentrées dans une région, plus le recours à la sous-traitance est important, ce qui s'explique par la plus grande offre de moyens de production à l'extérieur des entreprises.⁸³ Le type d'externalités locales qui a été le plus étudié est celui de la diffusion des connaissances. Par exemple, Agrawal *et al* (2006) ont montré, en étudiant les citations de brevets, que les connaissances développées par un inventeur sont appliquées de façon disproportionnée là où celui-ci résidait antérieurement, ce qui ne peut s'expliquer que par l'importance des relations personnelles⁸⁴ tandis que et Audrestch et Feldman (1996) ont fait ressortir la concentration géographique des innovations.⁸⁵

Il est manifeste que la spécialisation d'un grand nombre de pays en développement dans certaines activités tient davantage à l'expansion de secteurs déjà présents sur leur territoire, grâce aux externalités d'information et d'agglomération qu'à un réel avantage comparatif. En effet, comme le font observer Hausman et Rodrik (2003)⁸⁶, des pays dotés de presque les mêmes ressources au départ présentent des spécialisations très différentes: la Corée exporte des fours à micro-ondes, mais pas de bicyclettes, alors que Taiwan exporte des bicyclettes, mais presque pas de fours à micro-ondes, et le Bangladesh est l'un des principaux exportateurs mondiaux de chapeaux tandis que le Pakistan n'en exporte pratiquement pas. Ces constatations suggèrent que les spécialisations tiennent en grande partie à des événements aléatoires qui se produisent pendant la phase initiale du développement, c'est-à-dire à des initiatives aléatoires d'entrepreneurs agissant isolément qui enclenchent ensuite une dynamique auto-entretenu. Si c'est bien le cas, les gouvernements seraient donc fondés à subventionner provisoirement les nouveaux secteurs.

⁸² R. Nakamura, 2005, « Agglomeration economies in urban manufacturing industries: a case of Japanese cities », *Journal of Urban Economics*, vol.17, pp. 108-124.

⁸³ T.J. Holmes, 1999, « Localization of Industry and Vertical Disintegration », *Review of Economics and Statistics*, vol. 81(2), pp. 314-25.

⁸⁴ A. Agrawal, I. Cockburn et J. McHale, 2006, « Gone But Not Forgotten: Knowledge Flows, Labor Mobility, and Enduring Social Relationships », *Journal of Economic Geography*, vol. 6(5); voir aussi E. Moretti, 2004, « Workers' Education, Spillovers and Productivity: Evidence from Plant-Level Production Functions », *American Economic Review*, vol. 94(3).

⁸⁵ D.B. Audrestch et M. Feldman, 1996, « R&D Spillovers and the geography of innovation and production », *American Economic Review*, vol. 86, pp. 630-664.

⁸⁶ R. Hausman et D. Rodrik, 2003, « Economic Development as Self-Discovery », *Journal of Development Economics*, vol. 72.

Fait intéressant, un certain nombre d'observations portent à croire que les retombées locales positives locales (lorsque l'on tient compte de la taille des entreprises) sont moins importantes quand c'est une grande firme plutôt qu'une petite entreprise qui s'installe dans une région.⁸⁷ Cela tient probablement au fait que les grands établissements ont moins besoin d'interagir avec l'extérieur. D'autres observations ponctuelles tendent, toutefois, à prouver le contraire en faisant ressortir l'importance de grandes firmes dans le succès de pôles d'innovation (comme Nokia en Finlande).⁸⁸

Alors que l'on dispose de nombreuses informations sur la nature et l'ampleur des externalités d'agglomération, l'évaluation des politiques publiques censées les favoriser donne des résultats contrastés. Les tentatives de nombreux gouvernements de reproduire le modèle de développement de la Silicon Valley n'ont pas été concluantes même aux États-Unis où l'on disposait d'informations détaillées de première main. Dans une étude exhaustive des pôles d'innovation, l'OCDE souligne la diversité des mécanismes qui expliquent le succès de certains d'entre eux et elle conclut que: (i) il est très difficile de mesurer la contribution de l'intervention des pouvoirs publics au succès de certains de ces pôles, et (ii) il n'existe pas de recette universelle. Il est révélateur que l'un des pôles technologiques les plus performants des pays en développement, celui de la région de Bangalore, soit apparemment l'aboutissement d'une série d'événements fortuits (comme le refus d'IBM de céder aux actionnaires indiens 60% du capital de sa filiale en Inde qui a conduit l'entreprise à quitter le pays et contraint les informaticiens indiens à se tourner vers des plates-formes ouvertes, ce qui leur a permis d'acquérir des compétences qui se sont révélées très précieuses plus de dix ans plus tard).⁸⁹

À l'inverse, Rodrik (2004)⁹⁰ soutient que certaines politiques industrielles suivies en Amérique latine et en Asie de l'Est ont réussi à prendre en compte les externalités informationnelles et à favoriser le développement de secteurs entièrement nouveaux. Par exemple, au Chili, l'organisme public *Fundación Chile* a commencé à subventionner l'élevage du saumon dans les années 70. Alors que cette activité n'existait pas auparavant dans le pays, le Chili est aujourd'hui l'un des principaux exportateurs de saumon. Rodrik fait également valoir que la production d'orchidées à Taiwan par des entreprises publiques, c'est-à-dire avec l'aide de fonds publics, a été un bon moyen de mettre en évidence la rentabilité de cette activité pour stimuler l'investissement privé et le développement d'un nouveau secteur. D'après Rodrik (1995), le cas du conglomérat coréen Hyundai illustre de façon frappante l'utilité d'une politique bien conduite, axée sur un champion national. D'une part, le soutien public apporté à la diversification a permis à Hyundai d'internaliser les externalités du marché du travail puisque les cadres qui avaient acquis des compétences dans l'industrie du ciment et de la construction ont pu les utiliser dans d'autres secteurs quand Hyundai a développé de nouvelles activités, comme la construction automobile et la construction navale. D'autre part, les subventions publiques directes et indirectes (y compris sous la forme de garanties d'achat implicites pour la division de la construction navale, comme on l'a vu plus haut) ont encouragé Hyundai à rattraper les entreprises étrangères en place en termes d'efficience.

Rodrik souligne cependant les limites de ces politiques. Si les subventions à l'investissement dans de nouveaux secteurs ne sont pas strictement limitées dans leur champ d'application (secteurs vraiment nouveaux uniquement) et leur durée (phase de découverte seulement) et si elles ne sont pas subordonnées à un indicateur quelconque de résultat se référant au marché.

⁸⁷ Rosenthal, S. S. et W. C. Strange, 2003, « Geography, Industrial Organization, and Agglomeration », *Review of Economics and Statistics*, vol. 85 (2), pp. 377-393.

⁸⁸ Voir le chapitre consacré à la Finlande dans l'étude de l'OCDE publiée en 2001 sous le titre: « Innovative Clusters ».

⁸⁹ H. Pack et K. Saggi, 2006, « Is There a Case for Industrial Policy? A Critical Survey », *The World Bank Research Observer*, Banque mondiale, vol. 21(2).

⁹⁰ D. Rodrik, 2004, « Industrial Policy for the twenty-first century », *Harvard Kennedy School Working Paper* 04-047.

La conclusion générale que l'on peut tirer des études empiriques sur les effets d'agglomération est que ceux-ci sont importants, mais que les moyens d'action appropriés pour les exploiter sont complexes et ne sont pas encore bien compris. En particulier, si l'utilité d'une forme ou une autre de politique industrielle ne semble guère faire de doute, il y a apparemment de bonnes raisons d'axer celle-ci sur les petites entreprises qui se trouvent à un stade précoce de développement plutôt que sur les champions existants du fait que les diverses externalités mentionnées plus haut ont des chances d'être plus prononcées dans le cas des premières.

La possibilité d'utiliser des fonds publics pour favoriser le développement de pôles d'innovation a été reconnue dans l'Union européenne. Il est affirmé dans l'Encadrement communautaire des aides d'État à la recherche, au développement et à l'innovation⁹¹ que « *Les aides en faveur des pôles d'innovation sont destinées à remédier à la défaillance du marché liée aux problèmes de coordination qui entravent la création de pôles d'innovation ou qui limitent les interactions et les flux d'information à l'intérieur des pôles. Les aides d'État pourraient contribuer à régler ce problème de deux façons: d'abord en soutenant les investissements dans des infrastructures ouvertes et partagées pour les pôles d'innovation, ensuite en soutenant les activités d'animation des pôles, de façon à améliorer la coopération, la mise en réseau et l'apprentissage.* »

Les recommandations détaillées de l'Encadrement communautaire mettent en évidence la façon dont on peut réussir à subventionner des activités qui génèrent vraiment des externalités sans gaspiller les deniers publics. La Commission reconnaît les externalités positives que les pôles génèrent souvent et elle admet qu'elles peuvent justifier l'octroi de subventions, mais elle mentionne aussi deux mesures de sauvegarde. Premièrement, l'intensité maximale de l'aide autorisée est de 15% (avec des exceptions pour certaines régions sous-développées ou certains États membres). Deuxièmement, et surtout peut-être, l'aide doit être axée sur des dépenses directement liées aux externalités, c'est-à-dire des dépenses qui contribuent au fonctionnement du pôle sans que certaines entreprises s'en approprient directement les effets positifs. Ces dépenses incluent, par exemple, « les opérations de marketing pour attirer de nouvelles sociétés dans le pôle, la gestion des installations du pôle à accès ouvert et l'organisation de programmes de formation, d'ateliers et de conférences pour faciliter le transfert de connaissances et le travail en réseau entre les membres du pôle. »

3.5 Les subventions à la recherche, au développement et à l'innovation et la diffusion des connaissances

D'une manière plus générale, la recherche, le développement et l'innovation (RDI) sont souvent considérés comme générateurs d'externalités. Comme il est expliqué dans un commentaire récent sur le nouvel encadrement des aides à la recherche, au développement et à l'innovation, publié par la Commission européenne, des externalités positives peuvent exister pour les raisons suivantes: « les activités de RDI génèrent de nouvelles connaissances qui sont profitables à la société du fait qu'elles peuvent être utilisées par de nombreuses entreprises pour inventer ou améliorer des produits et des services. Du point de vue d'une entreprise, toutefois, seuls comptent les avantages qu'elle peut elle-même tirer de ses investissements dans la RDI. Il est de ce fait fréquent que les entreprises privées ne se lancent pas dans des activités de RDI parce qu'elles considèrent comme trop limités les avantages qu'elles peuvent en tirer alors que leurs effets positifs pourraient être importants pour la société grâce à la diffusion des connaissances qui en résulterait. Les activités de RDI génèrent de nouvelles connaissances qui ne peuvent pas toujours être protégées (à l'aide de brevets, par exemple). Des entreprises privées peuvent donc s'abstenir d'investir dans la RDI de crainte que les résultats de leurs investissements soient utilisés par leurs concurrents et qu'elles ne puissent en conséquence en tirer le moindre profit. Imperfection et

⁹¹ Encadrement communautaire des aides d'État à la recherche, au développement et à l'innovation (<http://eur-lex.europa.eu/LexUriServ/LexUriServ.do?uri=OJ:C:2006:323:0001:0026:FR:PDF>).

asymétrie de l'information: les activités de RDI sont particulièrement risquées et incertaines. Cela signifie qu'elles sont affectées par l'imperfection et l'asymétrie de l'information. De ce fait, trop peu de ressources humaines et financières sont investies dans des projets de RDI qui seraient cependant très utiles à la société. Problèmes au niveau de la coordination et des réseaux: les activités de RDI sont souvent incertaines et complexes et il n'est pas facile pour les entreprises privées de collaborer, de trouver des partenaires appropriés et de coordonner les projets de RDI. Du fait de ces problèmes, il est parfois renoncé à des projets de RDI qui auraient pu être menés conjointement par un groupe d'entreprises et qui auraient été profitables à l'ensemble de la société. »⁹²

Malgré toutes les qualités dont on gratifie les aides à la RDI, certains inconvénients ne doivent pas être négligés. Certes, la RDI intègre les externalités (grâce à la diffusion des connaissances) et les asymétries informationnelles (qui peuvent conduire à un financement insuffisant), mais ces asymétries impliquent aussi que l'aide à la RDI peut donner lieu à des inefficiences.

L'une des principales raisons en est que la R-D subventionnée peut évincer la R-D financée par le secteur privé du fait que les entreprises peuvent exagérer le degré auquel leurs investissements dans la R-D sont sensibles à l'aide octroyée.⁹³ Cette difficulté est illustrée par certaines affaires récentes concernant les aides accordées par des États européens. Dans sa décision Quæro⁹⁴, la Commission a autorisé l'octroi de subventions à un programme de recherche conjoint des secteurs public et privé. Elle a fondé son raisonnement sur les deux aspects suivants. Premièrement, l'existence d'une externalité activée par les dépenses de R-D de l'entreprise privée, les résultats de cet effort devant être diffusés par ses partenaires (universitaires) publics au lieu que l'entreprise se les approprie. Deuxièmement, pour déterminer si l'aide était susceptible d'avoir une incidence sur l'investissement en R-D de l'entreprise privée, la Commission s'est fiée aux estimations internes que le bénéficiaire avait établies des ressources qu'il prévoyait de consacrer au projet de R-D selon le niveau d'aide accordée. Ce type d'évaluation est probablement le meilleur qui puisse être effectué. Il est, toutefois, extrêmement simple par rapport aux analyses économiques entreprises par les autorités de la concurrence lorsqu'elles examinent des fusions, par exemple, et on peut se demander s'il ne pourrait pas être facilement manipulé par des entreprises manœuvrant pour obtenir des fonds publics sans aucune justification réelle au titre de l'intérêt public.

3.6 Les subventions environnementales

Comme on l'a vu plus haut, de nombreuses subventions existantes ont des effets préjudiciables à l'environnement, ne serait-ce qu'en raison du transfert de production qu'elles entraînent d'entreprises efficaces vers des entreprises qui le sont moins et qui sont aussi souvent moins respectueuses de l'environnement.

Toutefois, beaucoup de subventions visent aussi le développement d'énergies renouvelables dans le cadre des efforts déployés au niveau mondial pour réduire les émissions de dioxyde de carbone. Dans l'Union européenne, ces « aides en faveur de l'environnement » représentent un quart de l'ensemble des aides accordées à l'industrie (environ 13 milliards USD en 2008) et la Commission a publié, en 2008, les Lignes directrices pour les aides d'État à la protection de l'environnement, qui permettent aux gouvernements nationaux de prendre diverses mesures allant de l'octroi de crédits bonifiés pour toutes sortes d'initiatives favorables à l'environnement (comme le remplacement d'équipements industriels polluants par des équipements qui le sont moins) à des tarifs de rachat, c'est-à-dire des prix auxquels l'État s'engage à acheter l'électricité produites à partir de ressources renouvelables, comme l'énergie éolienne et l'énergie solaire.

⁹² T. Kleiner et R. Replinger-Hach, 2007, « The new community framework for state aid for research and development and innovation », *Competition Policy Newsletter*, vol. 1.

⁹³ P. David, B. Hall et A. Toole, 2000, « Is public R&D a complement or substitute for private R&D? A review of the econometric evidence », *Research Policy*, vol. 29(4-5), pp. 497-529.

⁹⁴ Décision N 469/2007, http://ec.europa.eu/community_law/state_aids/comp-2007/n469-07.pdf

En conséquence, 18 pays de l'UE appliquaient des tarifs de rachat en 2007 comme il en existe, notamment, au Canada, en Chine, en Israël et dans plusieurs États australiens. À première vue, la raison d'être de ces subventions est évidente puisque les investissements favorables à l'environnement constituent un exemple parfait d'externalité positive. Leur rationalité est, en revanche, loin d'être évidente puisque la combinaison de plusieurs subventions environnementales s'avère souvent incohérente, chaque mécanisme assignant un prix différent aux émissions de dioxyde de carbone. Par exemple, le prix de rachat actuel de l'énergie solaire en France suppose un prix implicite d'environ 1 000 EUR la tonne de dioxyde de carbone. Ce chiffre est à rapprocher du prix actuellement inférieur à 20 EUR dans le cadre du système européen d'échange de quotas d'émissions et du niveau de 17 EUR actuellement envisagé par le gouvernement français pour la « taxe carbone ».

Comme l'a fait ressortir le rapport Stern⁹⁵, la façon la moins coûteuse de réduire les émissions est de donner un signal de prix uniforme (à l'aide d'une taxe ou d'un système de permis fondé sur le principe du plafonnement et de l'échange) incitant tous les agents économiques à prendre des décisions pour réduire les émissions, dont le coût ne doit pas dépasser un certain seuil, sans décider de façon arbitraire comment les émissions devraient être réduites. Subventionner directement certaines façons de réduire les émissions risque, au bout du compte, d'augmenter le coût de l'effort de réduction des émissions et de rendre cet effort moins efficace. On peut, toutefois, nuancer ce point de vue en faisant valoir que certaines technologies renouvelables, encore balbutiantes, méritent d'être spécifiquement soutenues, en raison même du type d'externalité informationnelle examiné plus haut dans le contexte de l'aide aux nouveaux secteurs.

4. Comment les aides publiques et les subventions devraient-elles être contrôlées?

4.1 Les limites de l'analyse économique: les problèmes de mesure

Dans un monde idéal, il serait attendu de gouvernements bienveillants qu'ils évaluent chaque subvention potentielle en fonction de ses qualités particulières en essayant d'établir l'existence d'une externalité positive et de la chiffrer éventuellement, en estimant l'effet incitatif de l'aide et en procédant à une analyse coûts-avantages globale.

Mais, ce type d'évaluation, qui reposerait sur une hypothèse neutre et considérerait chaque mesure d'aide quant au fond uniquement n'est pas réaliste car nombre des conséquences positives et négatives des aides publiques, mentionnées plus haut, ne peuvent être mesurées.

L'évaluation des effets d'une aide présente des points communs avec celle des effets de fusions sur la concurrence. Dans les deux cas, l'objectif est de déterminer comment le marché sera affecté par un changement donné. Dans le cas des aides publiques, toutefois, cet exercice est beaucoup plus complexe que dans celui des fusions.

L'évaluation des effets unilatéraux, qui est au cœur du contrôle des fusions horizontales offre une comparaison utile. Son objectif, comparé à l'étendue des questions soulevées par l'analyse du contrôle des aides publiques, est relativement limité: elle ne s'intéresse qu'aux effets à court terme et considère la structure du marché comme une donnée (sauf pour les parties qui fusionnent, bien sûr). Elle se prête à la technique économétrique de la simulation de fusions qui permet d'obtenir des prédictions chiffrées reposant sur des demandes d'information limitées. Mais même dans ce cadre bien délimité, le contrôle des fusions est loin d'être totalement prévisible, surtout en ce qui concerne l'évaluation des efficiences.⁹⁶

⁹⁵ N. Stern, 2007, « The Economics of Climate Change: the Stern Review », Cambridge University Press.

⁹⁶ D. Gifford et R. Kudrle, 2005, « Rhetoric and Reality in the Merger Standards of the United States, Canada and the European Union », *Antitrust LawJournal*, vol. 72, p. 423.

Les questions qu'il faut considérer pour évaluer une mesure d'aide publique sont à la fois plus nombreuses et souvent moins chiffrables que des effets unilatéraux.

Prenons l'exemple de l'aide à la R-D. L'une des principales raisons qui justifient l'octroi d'une aide à la R-D est l'existence d'une externalité positive due à la diffusion des connaissances. Mais comment peut-on prouver, dans un cas particulier, la probabilité de cette diffusion? Les recherches empiriques entreprises sur cette question n'ont presque jamais été effectuées en établissant l'existence d'une diffusion des connaissances dans des cas particuliers, mais plutôt en étudiant de grands ensembles de données et en déterminant à l'aide de techniques statistiques élaborées qu'en moyenne il y avait eu diffusion de connaissances. En outre, même cette approche n'aboutit pas à des résultats certains, les conclusions des diverses études variant considérablement. Dans le cas des fusions, l'étude de celles qui ont été effectuées dans le passé sur le même marché peut souvent permettre de prédire ce qui peut se produire à l'avenir. Mais dans le cas de la R-D, ce type de démarche est moins prometteur du fait qu'il est difficile de trouver des précédents pertinents, surtout quand le but est d'évaluer une innovation qui n'existe pas encore et dont la nature est, par définition, incertaine. Cette difficulté rappelle celle à laquelle sont confrontées les entreprises qui soutiennent que des gains d'efficacité résulteront de la fusion qu'elles défendent. Ces affirmations sont souvent rejetées parce qu'elles ne sont pas vérifiables à l'aune des critères rigoureux des autorités de la concurrence. Le problème peut, toutefois, être même plus aigu pour le contrôle des aides publiques du fait que les innovations qui sont censées être encouragées sont plus radicales et donc plus incertaines et moins vérifiables que les améliorations progressives qui représentent la majorité des gains d'efficacité allégués dans le cadre du contrôle des fusions. Si et quand la probabilité d'une diffusion de connaissances peut être démontré, il faut aussi déterminer si la quantité de R-D est sensible au volume de l'aide. Il faut, pour cela, connaître non seulement le coût des fonds dont dispose l'entreprise et les contraintes de crédit auxquelles elle peut devoir faire face, mais aussi les autres possibilités d'investissement existantes pour le bénéficiaire de l'aide, l'effet de l'effort de R-D sur les coûts de production de l'entreprise à l'avenir ainsi que le niveau estimé de la demande du marché et des coûts marginaux des concurrents pour calculer comment une réduction donnée des coûts éventuellement réalisée grâce à la R-D, affectera les profits. La question est souvent encore plus complexe parce que la R-D vise souvent à créer de nouveaux produits plutôt qu'à réduire le coût de production des produits existants. Pour calculer si l'aide a des chances d'influer sur le comportement de l'entreprise, il faut formuler des hypothèses sur la fonction de demande dans le monde après la R-D, c'est-à-dire, par exemple, sur l'élasticité de substitution entre les produits des concurrents et le nouveau produit hypothétique que la R-D subventionnée pourrait éventuellement faire naître.

Cette difficulté n'est aucunement limitée à la R-D comme on peut le constater en passant à la question des inefficiences dynamiques, qui est souvent, et probablement à juste titre, mentionnée pour justifier le contrôle des aides publiques. Il n'y a pas de façon simple de chiffrer en toute certitude dans quelle mesure l'octroi d'une aide modifiera à long terme les attentes des agents économiques et donc leur comportement en matière d'investissement et d'innovation. Pour répondre à cette question, il faudrait évaluer l'effet de toute aide sur les attentes des autres entreprises quant à leurs chances de bénéficier d'une aide publique à l'avenir dans différents types de circonstances et mesurer l'effet de la modification de ces attentes sur le comportement futur des entreprises (prise de risque excessive ou « inefficience X » résultant du renforcement de la contrainte budgétaire, détournement des ressources de l'activité productive au profit de la recherche de rentes, etc.).

Enfin, pour évaluer quantitativement l'effet sur le bien-être d'une aide publique, il faut commencer par formuler une hypothèse quant au coût des fonds publics du fait que la perte subie par le contribuable entre généralement pour une large part dans le calcul de l'effet global d'une aide sur le bien-être. En fait, dans tous les modèles simples d'aides publiques génératrices de distorsions ainsi que dans les modèles simples de courses aux subventions, aucun effet préjudiciable n'est constaté sauf si cette perte sèche liée à la fiscalité est assez importante.

Ces observations semblent indiquer qu'il n'est peut-être pas justifié de supposer que les aides publiques ont un effet neutre sur la concurrence. Les données disponibles suggèrent que la plupart des subventions ont un effet négatif sur elle, cela devrait conforter l'idée qu'il revient aux gouvernements qui octroient une aide de prouver que ses retombées bénéfiques l'emporteront sur ses effets négatifs sur la concurrence. Ce type d'approche mettrait en évidence les inquiétudes suscitées par une politique systématique d'octroi d'aides publiques tout en laissant la flexibilité nécessaire à une évaluation au cas par cas.

Si le recours à l'analyse économique ne devrait pas être considéré comme une panacée justifiant l'hypothèse a priori d'un effet neutre, il peut néanmoins être très utile pour déterminer si une mesure d'aide donnée a des chances d'avoir un effet positif sur le bien-être social. L'analyse économique peut notamment jouer un rôle crucial en permettant d'établir l'existence de défaillances du marché et de déterminer si une subvention envisagée a des chances d'y remédier sans créer de graves distorsions, en contrepartie.

4.2 *Comment faire en sorte que « les aides d'État soient moins nombreuses et mieux ciblées »*

Les considérations qui précèdent mettent globalement en évidence les dangers que présentent les aides publiques et les subventions. D'une part, même des autorités locales, régionales ou nationales bienveillantes peuvent, rationnellement, se lancer dans une course destructrice aux subventions pour un coût considérable pour les deniers publics. D'autre part, les aides publiques échappent très difficilement aux pressions d'intérêts particuliers et elles contribuent elles-mêmes à la création de groupes d'intérêts qui exercent des pressions pour qu'elles soient maintenues même après qu'elles ont perdu leur raison d'être initiale. Même au sein de l'Union européenne où elles sont strictement contrôlées, on constate que les aides ne sont souvent pas vraiment justifiées et ne témoignent pas d'une utilisation très efficace des deniers publics.

Étant donné qu'il ne faut pas surestimer l'aptitude d'une administration ou d'un organisme spécialisé à évaluer une subvention éventuelle en fonction de ses qualités, il est logique d'envisager que les pays adoptent des règles qui rendent difficile l'octroi de subventions en général tout en laissant une certaine marge de manœuvre (une aide se justifiant parfois).

Beaucoup de pays ne disposent actuellement pas de règles permettant de contrôler strictement les aides publiques et là où des contrôles existent, ils n'empêchent pas l'octroi d'une aide importante.

Tout bien considéré, les mesures suivantes pourraient être prises par les gouvernements pour limiter l'octroi de vaines subventions et encourager les aides qui auront des effets économiques positifs à long terme.

Dans le cas des grands pays fédéraux, on pourrait envisager un contrôle fédéral sur les ensembles de mesures d'incitation qui peuvent être offerts aux entreprises au niveau infafédéral.

Les lois sur les faillites devraient moins inciter les pouvoirs publics à renflouer des entreprises uniquement pour sauver des emplois. En d'autres termes, elles devraient permettre que le coût de la faillite d'une entreprise soit minimal pour l'emploi et l'activité.

Le développement de fonds extraterritoriaux devrait aider les gouvernements à résister à la tentation de subventionner les matières premières que leur pays exporte. De même, des améliorations du système fiscal et de la possibilité pour les pouvoirs publics de redistribuer directement les revenus peuvent réduire les pressions politiques s'exerçant en faveur de l'utilisation de subventions génératrices de distorsions à des fins redistributives.

Les autorités de la concurrence devraient appliquer les mêmes critères aux entreprises et aux organismes publics qu'aux entreprises privées pour lutter contre les comportements anticoncurrentiels. En particulier, l'improbabilité d'une compensation des pertes ne devrait pas être considérée comme une justification acceptable dans les cas de fixation de prix d'éviction et dans les cas impliquant d'autres types de comportement d'exclusion. On pourrait ajouter à cela les « règles de neutralité concurrentielle du secteur public » qui existent déjà dans beaucoup de pays.

Les pays ou les groupements régionaux qui n'ont pas encore adopté de règles concernant la concurrence pour les aides publiques et les subventions devraient envisager de le faire. Même en l'absence de telles règles, les autorités de la concurrence devraient utiliser les outils dont elles disposent (surtout en ce qui concerne la répression des comportements anticoncurrentiels unilatéraux) pour remédier le plus possible aux effets de distorsion de la concurrence des aides publiques. Les gouvernements pouvant accorder de nombreuses façons une aide sous le couvert de mesures de politique générale non ciblée, une action de sensibilisation de la part des autorités de la concurrence s'impose aussi dans le cadre des efforts déployés pour limiter l'octroi stérile de subventions.

Les autorités de la concurrence devraient donc être consultées avant la prise de décisions sur les aides publiques susceptibles d'avoir des effets notables sur les marchés d'un secteur donné. Enfin, une coopération entre les autorités de la concurrence et les ministères concernés ne peut que favoriser une meilleure évaluation des avantages et des inconvénients de subventions précises.

D'une manière plus générale, des critères inspirés de la récente révision de la politique européenne de contrôle des aides d'État pourraient probablement être adaptés aux lois nationales de la concurrence à condition de tenir compte des contextes institutionnels et culturels. Il faudrait notamment: (i) exiger que chaque subvention fasse l'objet d'une analyse économique précisant quelle défaillance du marché doit être corrigée et les chances qu'elle a de l'être par la mesure d'aide; (ii) imposer qu'une subvention ne soit accordée que s'il peut être prouvé que le même objectif ne peut être atteint par une mesure plus transparente et moins discriminatoire (adjudication publique, par exemple) ou moins coûteuse pour les deniers publics (octroi d'un prêt à long terme ou achat d'actions par l'État, par exemple); (iii) limiter réglementairement l'importance et la durée des aides et la possibilité que celles-ci soient accordées régulièrement aux mêmes bénéficiaires, et (iv) adopter une disposition impliquant que lorsque de grandes entreprises en difficulté reçoivent des subventions, elles doivent faire des concessions en contrepartie, comme renoncer à certaines activités ou s'engager à ne pas utiliser l'aide pour se livrer à des pratiques d'exclusion.

La transparence et l'existence de mécanismes d'évaluation a posteriori devraient aussi permettre de limiter la possibilité, pour des intérêts particuliers, d'obtenir des subventions dénuées de toute justification économique.

ARGENTINA

I. The use of state aids in your country

1. Does your country regularly engage into the following practices? If so, could you provide information about: (i) the affected sectors; (ii) an order of magnitude of the corresponding amounts, and (iii) the evolution over time? If possible, distinguish between government-owned and private firms.

a. Direct subsidies to companies;

There have been some cases where the state gave direct subsidies to agriculture and dairy industry, though the net subsidy had a debit balance because these sectors had to pay export taxes which were higher than the state aid itself.

b. Tax breaks to selected companies or selected sectors;

No.

c. The granting of government-owned inputs (such as land, bandwidth, government facilities) to companies at a price below market levels (possibly a regulated price);

No.

d. Government purchases at above-market prices;

No.

e. The granting of loans at below-market rates;

Yes. For example, there has been a specific case in the automotive industry, where the state granted General Motors a loan for developing a car in which the majority of components ought to be from national industry.

f. The provision of loan guarantees at below-market rates.

No.

2. To what extent have state aids in your country been motivated by the following goals? For each of them, please specify whether domestic and foreign firms have been treated differently.

a. Protecting employment (in the case of aid to ailing firms);

This has been the main goal the state had whenever granting aid to the private sector, requesting firms not to fire any employees.

b. *Fostering innovation and the development of new sectors;*

There are special funds for I+D though they are not very significant because of the amounts granted. It is almost addressed to small business.

c. *Attracting firms to economically distressed regions;*

There are some cases like the province of Tierra del Fuego where the electronic industry is entitled with tax exemptions, and San Juan, San Luis and Mendoza where the principle aim is to promote agricultural industries.

d. *Remedying competition distortions created by the granting of aid by foreign governments;*

Only under the regular procedures of antidumping remedies.

e. *Inducing firms to supply goods or services deemed to contribute to the general interest in cases when market incentives alone were insufficient to ensure that these goods or services would be provided;*

It happened in the dairy and meat industries, where the state had to intervene to ensure these products would be produced.

f. *Palliating the undersupply of credit by the financial sector;*

Yes.

g. *Preventing strategic firms from being purchased by foreign companies.*

There is a case in which a large and very important national dairy company was into deep financial trouble. There was a proposal of purchase by a foreign company so the state mediated to help the local firm find the proper credit to solve its financial difficulties. The credit was granted by another country and it is being paid with products of the company.

3. *What are your country's laws, and the actual practice, regarding the provision of government owned or government-controlled inputs? In which circumstances is an auction process mandatory? In which circumstances does a non-discrimination clause apply? In practice, what is the prevalence of auctions? If possible, please provide information about the way in which the following inputs have been allocated.*

a. *License to operate a mobile telephony network (with access to the corresponding bandwidth);*

b. *License to operate a television network;*

c. *Access to natural resources.*

For answering all the previous questions, it is to say that the regulation so determines that auction process is mandatory.

All these cases have being allocated by auction process.

The non discrimination clause is the rule though there is a specific case in which it doesn't fully applies. This is the case of the "Compre Nacional" exemption, which is applicable for the provision of

those inputs the state needs for the regular administrative function (The government should choose a national provider if his offer is no more higher than 10%).

The sole exemption of not using an auction process comes in the case of urgency of buying things under special cases (remedies in a natural disaster, etc.)

II. Aid to ailing companies, especially in the context of the financial crisis

1. In the context of the financial crisis, did your country provide emergency aid to some companies? If possible, please provide information on:

a. Specific rescue measures for banks and other financial institutions;

There were not “rescue measures” but a wider credit line from the Central Bank to the commercial banks.

b. Aid to industrial firms (for instance in the car industry).

The previously mentioned credit to General Motors.

2. What are the criteria that have been used when delineating the beneficiaries of emergency aid, as well as the amount or nature of the aid?

The specific needs from the taker, without discriminating between national or foreign firms but mainly regarding the maintenance of jobs.

3. Is aid to ailing companies in your country usually provided with conditions attached such as:

a. Clauses imposing at least partial reimbursement in the event of a return to better fortunes?

Banks already gave back the credits they’ve been granted with and in the case of the agriculture sector there is no reimbursement demand.

b. A cap on executive pay?

No.

c. Restructuring (for instance, the closing of unprofitable factories or branches)?

No.

d. Guarantees on total employment?

Yes.

e. Clauses prohibiting the use of government funds in order to engage in predatory strategies?

Not specified but predatory strategies are prohibited by law.

f. An explicit commitment that the aid will be limited in time and will not be repeated?

No.

g. Commitments regarding the environmental impact of the recipient's activity?

No.

3. Does aid to ailing companies in your country sometimes take the form of temporary government ownership in return for capital injection? If so, are there examples where such policies allowed the government to turn a profit after the aided firm's situation improved?

There's been a recent situation with the national airline, afterwards privatised. As the owner was going through financial difficulties, the state bought the company. The owners were the same of Air Commet that recently falls dawn.

III. Legal restrictions on state aids

1. Do competition authorities exert some control on state aids in your country? If so, has this control been weakened in the context of the financial crisis? Are there specific rules about aid to ailing firms, or aid to R&D? Please detail each, briefly.

No.

2. Is the amount and nature of state aids limited by virtue of regional trade agreements to which your country participates (not taking into account WTO disciplines)? If so, is there a supranational control mechanism? Has it ever been used? In competition cases?

No, but there are bilateral negotiations when the imbalance starts affecting the local firms.

3. Did the competition authority in your country ever have to consider a case involving state aids? If possible, please distinguish the following (possibly overlapping) types of cases:

a. A private company complaining about predatory strategies (or unfair practices) implemented by a public company or by a private company benefitting from public funds (for instance in the case of a firm providing a public service and using the corresponding revenues in order to compete aggressively on an other market);

No.

b. A company complaining about discriminatory treatment, in comparison to a competitor benefitting from state aids;

No.

c. Cases involving the existence of price regulation;

No.

d. Cases involving abuse of dominance or merger cases (for example, in the latter, would remedies be affected if the state aid were to be withdrawn?).

No.

4. *Are government-owned companies subject to competition law to the same extent as private companies in your country? Are there any specific mechanisms for their implementation?*

Yes, as any other private company.

5. *To what extent are state aid issues addressed in your competition authority's advocacy activity? What is your competition authority's message on state aids? Is this message well understood and taken duly into account by other parts of the government? Please describe briefly the relevant institutional mechanism(s), if any.*

The National Commission for the Defense of Competence has given its opinion publicly, in several conferences, advising the limitation in time and amount of these state aids, in order to minimise market distortions.

These recommendations can be resumed as followed:

These measures have to be exceptional, only justified by an interest superior to competence.

They ought to be of the slightest intensity possible, in amount and in duration.

They must be very transparently granted.

As for the objective of their existence, they should be non discriminatory, directed to benefit the sector instead of the company, or at least directed to benefit the firm instead of the owner of it. Besides, the benefits should be published.

They should tend to benefit the domestic market, but always considering the regional and global context.

Finally, the measures should try to promote international competitive companies which could offer goods and services of the greatest aggregated value.

CROATIA

1. Introduction

The scope of the State Aid Act of the Republic of Croatia (2005) is to set out general conditions and rules for authorisation, monitoring the implementation and recovery of state aid for the purpose of the implementation of the international commitments undertaken by the Republic of Croatia, arising under the Stabilization and Association Agreement between the Republic of Croatia and the European Communities and their Member States (further: SAA), whereas, the state aid to agriculture and fisheries is not covered by the same Act.¹ The provider of state aid is the Republic of Croatia through its authorised legal entities and central public administration authorities, local and regional self-government units and any legal entity granting or administering state aid. The beneficiaries of state aid are legal and natural persons who perform an economic activity and thereby participate in the trade of goods and services and who receive some form of state aid.²

2. The definition of state aid

Within the meaning of the State Aid Act, state aid represents any actual and potential expenditures or decreased revenue of the state granted in any form whatsoever by the aid provider, which distorts or threatens to distort competition by favouring certain aid beneficiaries, insofar as it may affect the international commitments undertaken by the Republic of Croatia. Furthermore, the state aid scheme represents any legal document on the basis of which, without any additional implementing measures required, individual aid may be granted to ex ante unspecified aid beneficiaries, and any legal document on the basis of which state aid which is not linked to a particular project may be awarded to one or more aid beneficiaries for an indefinite period of time and/or in an indefinite amount. Finally, individual state aid represents any state aid which is not granted under the aid scheme, and any state aid granted under the aid scheme which is subject to additional authorisation from the side of the Croatian Competition Agency.³

3. General prohibition and exemptions from the general prohibition

Based on the Croatian State Aid Act, state aid in any form whatsoever, which distorts or threatens to distort competition by favouring certain aid beneficiaries, insofar as it may affect the international commitments undertaken by the Republic of Croatia shall be incompatible with the Law.⁴ However, state aid to mitigate or compensate the damage caused by natural disasters, exceptional or war occurrences may be declared as compatible with the Law, subject to prior authorisation of the Croatian Competition Agency, if the same does not affect the international obligations based on the Republic of Croatia's international agreements with third countries. Therefore, the following kinds of state aid may be considered to be compatible with the State Aid Act: (i) state aid to promote the economic development of areas where the standard of living is abnormally low or where there is serious underemployment; (ii) state aid to promote

¹ Art. 1. of the Act.

² Art. 2. of the Act.

³ Art. 3. of the Act.

⁴ Art. 4. of the Act.

culture and heritage conservation; (iii) state aid to promote the execution of important international projects or to remedy a serious disturbance in the economy; (iv) state aid to facilitate the development of certain economic activities or of certain economic areas; (v) state aid to legal and natural persons which are in accordance with special rules entrusted with the operation of services of general economic interest or granted special rights to perform tasks assigned to them in the public interest, where in the case of absence of such aid these persons would be obstructed in the performance of the particular tasks assigned to them and provided that the aid in question exclusively covers the compensation for the performance and implementation of the tasks concerned.

4. Authority which holds jurisdiction over the assessment and authorisation of the state aids

The Croatian Competition Agency (hereinafter: the Agency) is the authority which holds jurisdiction over the assessment, authorisation, and monitoring of the implementation of state aid and is entitled to order the recovery of unlawfully granted state aid or aid used in contravention of the Law.⁵ The Agency is entrusted with the following empowerments: (i) assessment and consideration of state aid proposals and aid schemes within annual and multi-annual state aid approval plans; (ii) monitoring of the implementation and effects of state aid granted and empowerment to order the recovery of unlawfully granted state aid or aid used in contravention of the Law; (iii) collecting, processing and registering the data in relation to the already granted state aid; (iv) collecting data on the use and effects of state aid granted; (vi) keeping the state aid register; (vii) cooperation with the authority responsible for state aid to agriculture and fisheries in the preparation of annual reports on state aid; (viii) cooperation in the budget preparation process with the authorities responsible for the preparation of the state budget and the budgets of regional and local self-government units; (ix) reporting on granted amounts of the state aid to the Croatian Parliament annually; (x) cooperation with international authorities, in compliance with the international commitments undertaken by the Republic of Croatia; (xi) participation in the preparation of draft proposals of the legislation concerning state aid, as well as promoting and encouraging improvements in the state aid system; (xii) performing other activities relating to the implementation of the State Aid Act.⁶

5. Proceedings in front of the Agency

5.1 General

The Agency is empowered to request in writing all data and documents it deems necessary for the authorisation and assessment of the particular state aid case, from the aid provider and aid beneficiary, respectively.⁷ Furthermore, the Agency issues Preliminary Binding Opinions on any draft proposals of laws which contain state aid before its submission to the Government of the Republic of Croatia, upon the request of the ministries and other public administration authorities, that grant the state aid to various beneficiaries.⁸ The Preliminary Binding Opinion is usually submitted to the Government of the Republic of Croatia and Croatian Parliament along with draft proposals of laws and other regulations containing state aid. Ordinarily the Agency issues opinions within 30 days after the receipts of the proposals from the side of ministries and other authorities in charge. The Agency's authorisation of the state aid can follow a priori and/or ex post. Namely, before any legislative proposals, which contain state aid, would be submitted to the Government of the Republic of Croatia for its adoption, ministries and other public administration

⁵ Art. 5. of the Act.

⁶ Art. 6. of the Act.

⁷ Art. 9. of the Act.

⁸ Art. 10. of the Act.

authorities are obliged to notify the state aid proposals in question to the Agency for its authorisation (authorisation a priori).⁹

5.2 Recovery and ex post authorisation of state aid¹⁰

State aid which is granted without authorisation of the Agency is presumably illegal. In such cases, the Agency shall order recovery of the state aid used, increased by statutory interest on arrears payable from the date on which the unlawful aid was first used. However, without prejudice to that stated above, the Agency may in duly justified cases grant an ex post authorisation of state aid if it finds that the state aid in question is compatible with the state aid rules. The ex post authorisation of the Agency may lay down particular conditions and time limits subject to which the state aid in question may be implemented.

5.3 Monitoring the implementation and recovery of state aid

The Agency shall monitor the implementation of authorised state aid ex officio or upon the proposal of aid beneficiaries, aid providers and any legal or natural person having a legal interest. In such cases where the Agency might establish any irregularities in monitoring the implementation of state aid, there can be adopted a decision ordering the aid provider and/or aid beneficiary to remedy the irregularities in question within no longer than 3 months.¹¹ In the case that the aid provider and/or aid beneficiary would not remedy the irregularities in question within the given time limit, the Agency shall order the aid provider and/or aid beneficiary recovery of the awarded state aid in the part in which irregularities have been established, increased by statutory interest on arrears payable from the date on which the established irregularities occurred. Furthermore, if the Agency would establish that a particular authorised aid scheme was no longer compatible with the international commitments undertaken by the Republic of Croatia, it shall issue a recommendation proposing to the aid provider concerned substantive amendment of the aid scheme or abolition of the aid scheme. Following the Agency's request, the aid provider concerned shall initiate the procedure for amending or abolishing the aid scheme in question within 90 days from being noticed, and then is obliged to inform the Agency about the measures taken without further delays.¹²

5.4 State aid data and state aid register

The Competition Council shall lay down the form and content of the notification and the method of data collection and keeping the State Aid register.¹³

5.5 Publication

Opinions and decisions of the Agency and judgments rendered by the court of competent jurisdiction which are based on the opinions and decisions concerned shall be published in the Official Gazette of the Republic of Croatia.¹⁴ Regulations and bylaws necessary for the implementation of the State Aid Act are also published in the Official Gazette, and in many cases also available on the Agency's web site – www.aztn.hr.

⁹ Art. 11. of the Act.

¹⁰ Art. 14. of the Act.

¹¹ Art. 15. of the Act.

¹² Art. 16. of the Act.

¹³ Art. 17. of the Act.

¹⁴ Art. 18. of the Act.

6. Call for contributions by the OECD Secretariat for Session 1 on State Aids and Subsidies

I. The use of state aids in your country

1. Does your country regularly engage into the following practices? If so, could you provide information about: (i) the affected sectors; (ii) an order of magnitude of the corresponding amounts, and (iii) the evolution over time? If possible, distinguish between government-owned and private firms.

a. Direct subsidies to companies;

Yes.

b. Tax breaks to selected companies or selected sectors;

Yes.

c. The granting of government-owned inputs (such as land, bandwidth, government facilities) to companies at a price below market levels (possibly a regulated price);

No.

d. Government purchases at above-market prices;

No.

e. The granting of loans at below-market rates;

No.

f. The provision of loan guarantees at below-market rates.

Yes.

2. To what extent have state aids in your country been motivated by the following goals? For each of them, please specify whether domestic and foreign firms have been treated differently.

Domestic and foreign firms are equally treated.

a. Protecting employment (in the case of aid to ailing firms);

Yes (through restructuring aids).

b. Fostering innovation and the development of new sectors;

Yes.

c. Attracting firms to economically distressed regions;

Yes.

d. *Remedying competition distortions created by the granting of aid by foreign governments;*

No.

e. *Inducing firms to supply goods or services deemed to contribute to the general interest in cases when market incentives alone were insufficient to ensure that these goods or services would be provided;*

Yes, Services of General Interest (SGI's).

f. *Palliating the undersupply of credit by the financial sector;*

No.

g. *Preventing strategic firms from being purchased by foreign companies.*

No.

3. *What are your country's laws, and the actual practice, regarding the provision of government-owned or government-controlled inputs? In which circumstances is an auction process mandatory? In which circumstances does a non-discrimination clause apply? In practice, what is the prevalence of auctions? If possible, please provide information about the way in which the following inputs have been allocated.*

a. *License to operate a mobile telephony network (with access to the corresponding bandwidth);*

Not applicable under state aid statutes.

b. *License to operate a television network;*

Not applicable under state aid statutes.

c. *Access to natural resources.*

Not applicable under state aid statutes.

II. *Aid to ailing companies, especially in the context of the financial crisis*

1. *In the context of the financial crisis, did your country provide emergency aid to some companies? If possible, please provide information on:*

Within the framework for combating the global financial crisis, the Croatian Government had created 4 programmes of aid through the Croatian Bank for Reconstruction and Development (HBOR) and 1 programme of aid through the Ministry of Economy and Labour.

a. *Specific rescue measures for banks and other financial institutions;*

No.

b. *Aid to industrial firms (for instance in the car industry).*

Yes (except for the car industry).

2. *What are the criteria that have been used when delineating the beneficiaries of emergency aid, as well as the amount or nature of the aid?*

There have been used the criteria measured for the firms that have been in financial crisis.

3. *Is aid to ailing companies in your country usually provided with conditions attached such as:*

- a. *Clauses imposing at least partial reimbursement in the event of a return to better fortunes?*

No.

- b. *A cap on executive pay?*

Yes.

- c. *Restructuring (for instance, the closing of unprofitable factories or branches)?*

Yes.

- d. *Guarantees on total employment?*

No.

- e. *Clauses prohibiting the use of government funds in order to engage in predatory strategies?*

No.

- f. *An explicit commitment that the aid will be limited in time and will not be repeated?*

Yes.

- g. *Commitments regarding the environmental impact of the recipient's activity?*

Yes.

4. *Does aid to ailing companies in your country sometimes take the form of temporary government ownership in return for capital injection? If so, are there examples where such policies allowed the government to turn a profit after the aided firm's situation improved?*

Yes.

III. Legal restrictions on state aids

1. *Do competition authorities exert some control on state aids in your country? If so, has this control been weakened in the context of the financial crisis? Are there specific rules about aid to ailing firms, or aid to R&D? Please detail each, briefly.*

Yes.

2. ***Is the amount and nature of state aids limited by virtue of regional trade agreements to which your country participates (not taking into account WTO disciplines)? If so, is there a supranational control mechanism? Has it ever been used? In competition cases?***

No.

3. ***Did the competition authority in your country ever have to consider a case involving state aids? If possible, please distinguish the following (possibly overlapping) types of cases:***

- a. ***A private company complaining about predatory strategies (or unfair practices) implemented by a public company or by a private company benefiting from public funds (for instance in the case of a firm providing a public service and using the corresponding revenues in order to compete aggressively on another market);***

So far the Croatian Competition Agency did not have such a case, but if we had it we would act upon the complaint.

- b. ***A company complaining about discriminatory treatment, in comparison to a competitor benefiting from state aids;***

Yes, we opened several investigations upon the complaint (sector of Textile Industry).

- c. ***Cases involving the existence of price regulation;***

No.

- d. ***Cases involving abuse of dominance or merger cases (for example, in the latter, would remedies be affected if the state aid were to be withdrawn?).***

No.

4. ***Are government-owned companies subject to competition law to the same extent as private companies in your country? Are there any specific mechanisms for their implementation?***

Yes absolutely.

5. ***To what extent are state aid issues addressed in your competition authority's advocacy activity? What is your competition authority's message on state aids? Is this message well understood and taken duly into account by other parts of the government? Please describe briefly the relevant institutional mechanism(s), if any.***

State aid and competition advocacy are well done and prepared carefully; these are inevitable activities of the Croatian Competition Agency with a long tradition of implementation. The relevant institutional mechanisms are through the annual reports on state aids which are submitted to the Croatian Parliament.

EGYPT

1. Introduction

State aid policy has a part to play in the transformation of a planned economy into an open market economy with free competition. However, a state aid policy is not a stand-alone regulatory too, it certainly has its impact on competition policy. The intensity of this impact depends on the level of the state intervention, the benefitting sector where the undertaking concerned is functioning and other factors. Reflections on the interface between state aid, competition law and policy have been drawn worldwide. Nonetheless, the awakening in this field of research has not been accompanied by much thinking in Egypt. Studies investigating into the consequences and impacts of state aid on the implementation of competition law in Egypt have lagged behind, and no single work can be mentioned. It is both because the literature on competition law and policy has taken little attention in Egypt; and the Egyptian competition law¹ in 2005 and its Executive Regulations do not contain prohibition on state aid, which distorts or may distort competition in the market. Moreover, the obligations on the government to adopt state aid policy that does not distort competition as mentioned in the Egypt-EU trade agreement² as well as its Action Plan,³ were expected to be implemented on June 2009. Nothing materialised in this regard until today.

Egypt's state aid or subsidies policy has not been formulated in the general economic framework. In other words, there is no concrete definition of what qualifies a certain practice by the government as a state aid. No mechanism for identifying or controlling such practices exists. There are no laws that regulate or define state aid in Egypt.⁴ Therefore the term employed in most of the literature on aid focussed on subsidies and not state aid.

Egypt has used subsidies as an active policy choice since the World War II. Subsidies and other artificial supports were a necessary part of industrial policy in Egypt, however, laws were neither promulgated to define such a policy nor to prohibit it when it is harmful to competition policy, as will be shown below.

2. Characteristics of Subsidies

The financial transfers and other forms of direct and indirect aid to entire sectors or individual enterprises were very frequently employed to boost economic development and to promote employment in the more backward regions of the country as well as for the achievement of industrial policy objectives.⁵

¹ Law No. 3 of 2005 promulgating the law on the protection of competition and the prohibition of monopolistic practices.

² O.J L.345, 31/12/2003, paragraph 0115-0116. The Agreement is replacing the 1977 Co-operation agreement.

³ O.J.L 230/19, "Recommendation No.1/2007 of the EU-Egypt Association Council of 6 March 2007".

⁴ Only the law of the State Budget No. 87 of the year 2005 defines subsidies as the transfer from the government to support producers or consumers to enhance the standard of living.

⁵ It is worth noting that a study conducted by the World Bank in 2005 "*Egypt-Towards a More Effective Social Policy: Subsidies and Social Net*" notes that the public social safety net in Egypt does not follow the typical programmes in many countries. It is devoted to consumer subsidies on food; energy subsidies to

The responsibility for supervising and monitoring the subsidies in Egypt is under the competence of the Ministry of Finance. The Ministry of Finance grants subsidies directly to firms where the value of the aid and the recipient are known, as it is recorded in the State Budget. It can also grant subsidies indirectly through other Ministries. For instance, it could allocate a certain fund from the State Budget to the Ministry for Trade and Industry, which in its turn transfers the fund to the Egyptian Export Promotion Centre to grant aid to a given company or a group of companies. In the latter case only the value of the aid is known, but not the recipient.

The aid could take the traditional forms such as direct financial transfers, tax breaks, granting of government-owned inputs below market prices, government purchases above market prices, or the provision of loans below market rates. The aid could also take another form such as preferential treatment including regulations or enforcements. For example, the Egyptian Civil Aviation Law and its Executive Regulations explicitly mandate that no airline can be licensed to operate on internal routes that compete with the itineraries of currently operating Egyptian companies.

The term used by the government for the transfer of public resources from the state to economic entities or the general public is “Subsidies, Grants, and Social Advantages”. The official figures data are usually reported in Chapter 4 of the State Budget. Some items can also be traced in Chapter 7 of the State Budget. The subsidies in Egypt are divided into two forms. A substantial part of the subsidies granted by the government is explicitly stated in the State Budget. These subsidies are mainly a tool to achieve social objectives, e.g. helping consumers with low income, encouraging economic activity for a certain area, or preventing the decline of an industry. The other form of subsidies does not appear explicitly in the State Budget.⁶ A good example is some transfer granted by the Ministry of Finance to settle debts of some public sectors banks including Bank of Alexandria in the year 2005/2006.⁷ This transfer is estimated at 1.27 billion Euros. Another example of aid granted by the Minister of Finance after the Prime Minister’s approval to banks to retain the government share of profits for provisioning and improving these banks’ financial viability. These voluntary retained earnings are estimated at 127 million to 381 million Euros for the past three years. The beneficiaries of subsidies in Egypt could be government-owned enterprises or private firms. The latter could include foreign owned companies.

3. The Allocation of Subsidies

The main component of subsidies granted by the Egyptian government target food and petroleum sectors. The programme of food subsidies had its beginning in the effort to cope with inflation after World War II. Since then food subsidies have increasingly become a crucial element in state aid and an important means to ensure political stability. Since the 1952 Coup d’état the government took major steps to support an equitable distribution of food and income in Egypt.⁸ Since the appointment of the new cabinet of 2004, the government expanded food subsidies. In 2008-09 its financial cost reached 2.2 percent of the GDP. The same pattern can be witnessed in the energy subsidies, which increased dramatically in recent years. This was largely because of the growing gap between the rapidly increasing international prices and the slowly

producers and consumers, which serves as important state aid; income-generation programmes that provide financial credit and in-kind support to the disadvantaged to foster entrepreneurship and business development; social insurance reflected in the pension scheme; Social Fund of Development programmes; and social assistance cash transfer from The Ministry of Insurance and Social Affairs.

⁶ The value of such subsidies does not show explicitly in the State Budget, however, it is issued by ministerial decrees or Prime Minister decisions to target certain sectors or industries.

⁷ Minister of Finance, “the Fiscal Policy Statement” (2006) approved by the Parliament.

⁸ See above note 3, World Bank (2005), “*Egypt-Towards a More Effective Social Policy: Subsidies and Social Net*”, 41.

increase of domestic prices. The recent devaluation of the currency has further contributed to the increase in these subsidies. The petroleum subsidies are substantial with their economic cost reaching 6.4 percent of the GDP in 2008-09.

Table 1: Trend of subsidies according to the state budget from 2004 to 2009

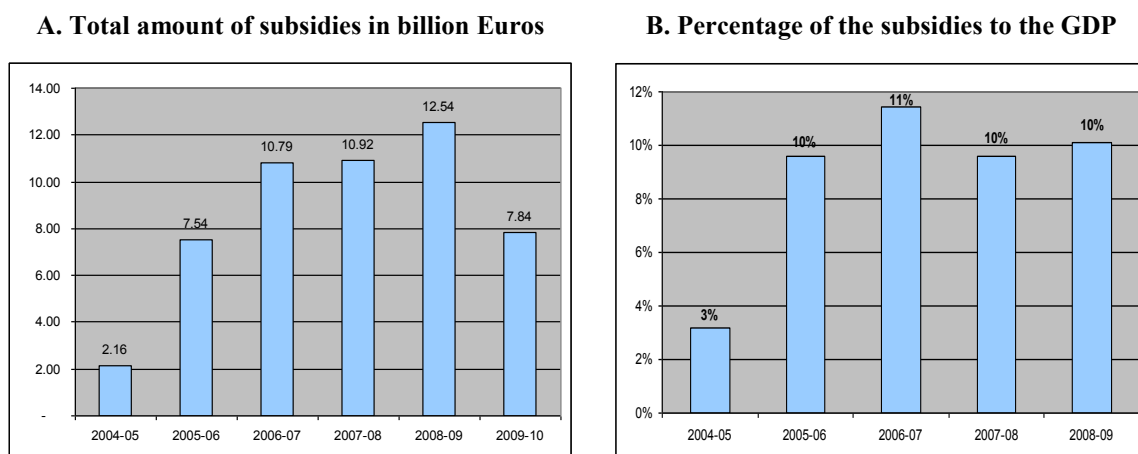

Source: Ministry of Finance. The above figures are calculated as a percentage from the GDP from the State Budget years 2004 to 2009.

As shown in Table 1.A, the subsidies in Egypt reached its highest level in 2008-09 to be 12.5 billion Euros. This increase could be justified by the global financial crisis of 2008 to adjust its negative impact Table 1.B shows that the allocated subsidised in Egypt reached an average of 9 percent of the GDP from 2004 until 2009 (see Table 1.B above).

Figure 1: The average of the distribution of subsidies by sectors [years 2004 to 2009]

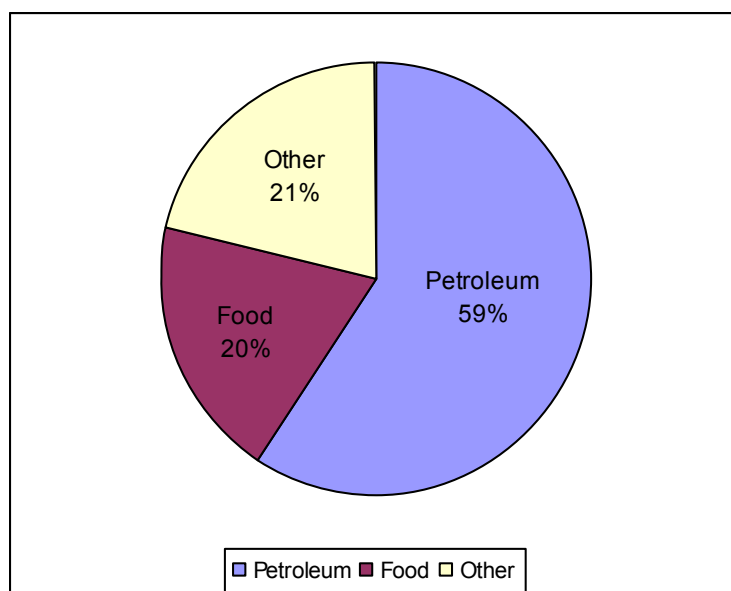

Source: Ministry of Finance' State Budget.

In addition, Figure 1 below illustrates that the gap between subsidies to the petroleum sector and the other sectors in the economy is quite large. Petroleum products receive 59 percent of the subsidies. Some of the aid to petroleum products is considered to serve energy-intensive industries (excluding the food and textile industries) but includes industries such as cement, steel, chemicals, fertilisers, aluminium. As shown the food subsidies represent 20 percent. The remaining 21 percent of annual subsidies is directed to soft loans, employee training, and subsidies for farmers.

4. Interplay between State Aid and Competition Law and Policy

Although the introduction of competition law and policy in Egypt is without a doubt a significant economic phenomenon, it does not prohibit state aid, which distorts or may distort competition in the market. Therefore, the Egyptian competition authority (ECA) has not been involved in any occasions since its establishment with complaints from enterprises denouncing competition distortion effects of state subsidies being granted to the complainants' competitors. Saying that, Article 1 of the competition law sets the main objective as follows: "Economics activities shall be undertaken in a manner that does not prevent, restrict or harm competition in accordance with the provisions of the law." The broad sweep claimed by Article 1 in relation to the goal of the law begs the question on why subsidies or aids that have anticompetitive effects occurring in the market, or in other contiguous or unrelated markets through cross subsidisation practices, are not prohibited by the law.

Since the ECA started its activities in 2006, the ECA has conducted studies covering various sectors, food (e.g. sugar, meat, dairy products and edible oil), construction sector (e.g. cement, glass and steel), and chemicals (e.g. fertilisers). By reviewing these studies, the dynamics of different markets in Egypt, as well as the issue of setting forth the concept of subsidies and distortion of competition, the following issues seem to deserve further consideration.

First, subsidies are usually associated with the government intervention by fixing prices of the subsidised goods. This intervention creates a segment of the market that does not fall under the jurisdiction of the Egyptian competition law. As a consequence, the ECA investigates only the segment of the market that is free from government's regulations and subsidies. In the edible oil market study, the ECA only investigated 22 percent of such a market as the remaining 78 percent was subsidised. In this case as well as in other similar cases, the narrow analysis of the market may not reflect its real dynamics. Even worse, it could mislead the decisions on anticompetitive practices, and/or impede the implementation and enforcement of the law.

Second, the Egyptian economy is characterised by a high level of concentration. This concentration was revealed in the cement industry, where only three firms held more than 63 percent of such a market. Another example is the fertiliser market, where two companies control more than 90 percent. Garcia and Neven demonstrate that the significance of competition distortion resulting from a state aid is likely to increase in the presence of market concentration.⁹ Thus, sustaining the current high level of subsidies in Egypt could greatly weaken the level of competition in the market. Moreover, it may reduce the attractiveness of the market to investors and hinder the growth of emerging sectors.¹⁰

Third, informal sector is considerably large in Egypt. This can be exemplified by the high ratio of the informal enterprises to the total small and medium enterprises, which approximately amounts to 82 percent. However, it is worth noting that some Egyptian firms operate simultaneously in both the formal

⁹ J. Garcia and D. Neven, "State Aid and Distortion of Competition: a Benchmark Model", 6 HEI Working Paper (2005), Graduate Institute of International Studies.

¹⁰ For example, subsidising petroleum products could adversely provide people with no incentive to buy more fuel-efficient cars or switch to cleaner fuels.

and informal sector (by having underground activities). In that sense, these firms could reap all the benefits of operating formally such as subsidies. Busato, Chiarini, and De Angelis noted that subsidising such enterprises may encourage them to increase their underground activities, as they will have less incentive to increase their reported capital and risk a reduction in the level of aid received.¹¹

From the above one can deduce that subsidy policy, which is often reflected in public intervention as a tool to correct market failure and/or to achieve social objectives, is far from being a sufficient condition. It is hence required on policy grounds, at the national level, to show when the subsidy is not distorting competition and when it is necessary and proportionate to its objectives.

Finally, besides the requirements of defining and preventing state aid that distort competition at the national level, there is the requirements of the Egypt-EU association agreement signed in 2004 of the adoption of a clear definition of state aid and a national mechanism for collecting information on state aid in order to ensure the implementation of the competition Article (34.3) of the agreement. The reason is to ensure the prohibition of state aid that distorts competition according to Article 34. As stated in the EU-Egypt Action Plan, this mechanism for collecting information on state aid should be realised by exchanging with the EU an annual report on the total amount and distribution of state aid, as well as exchange of knowhow and experience in regard to state aid control regime.¹² Furthermore, the adoption of a state aid control regime and legislation was one of the requirements of the EU in the context of the approximation of Egyptian national law to that of the EU *acquis*, including a system of an *ex-ante* control of state aids, which distorts trade between the EU and Egypt.¹³ This is to prepare Egypt's participation in the EU internal market.

5. A Step Ahead for Harmful State Aid and Distortion of Competition

This is the first encounter for Egypt with the subject of state aid and distortion of competition. As has been discussed, too much attention has sometimes been paid in the past to aid, and as seen the ratio of subsidies in Egypt to GDP has roughly tripled. Two main obstacles may result from this high state aid ratio and the lack of rules to regulate it in order to prevent aid that may distort competition. The first relates to bolstering vested interest by some producers to unproductive subsidy. The second obstacle is reducing the competitive playing field to favour firms in certain sectors that receive state aid whether directly or indirectly.

The law and its Executive Regulations are very much a work in progress and will, in all likelihood, be amended several times down the road, which will necessitate a reform in order to establish a precise definition of what constitutes state aid. This in turn will necessitate that the ECA should be equipped to investigate and control the aid that may be considered distorting competition and hence infringing the law. Therefore, the authority should take the appropriate measures regarding this issue one of which is the training of its employees for such aid rules. Therefore, more can be done at the competition authority level, such as developing competition scrutiny of state aid in order to reform the law to have provisions on this issue. This is to effectively deter and prevent the aid that is likely to distort competition. Criteria for intervention within competition policy against competition-distorting subsidies need to be developed and wider policy ground principles of good subsidy design need to be created. Moreover, the ECA should consider studying empirical evidence from other developing countries such as the Central and Eastern

¹¹ F Busato, B. Chiarini and P. De Angelis “*State Aid Policies and Underground Activities*”, Discussion Paper (2007), Department of Economic studies, University of Naples, Parthenope, Italy.

¹² O.J.L 230/19, “Recommendation No.1/2007 of the EU-Egypt Association Council of 6 March 2007”.

¹³ Ibid.

countries when preparing for their accession to the EU, to draw the relevant lessons in regard to the adoption of provisions on state aid that are in full convergence with the EU *acquis*.

At the government level, new state aid mechanism has to substantially be initiated. The old policy towards state aid from the government has to be sharpened further by including competition aspects inside the remit of such a policy. This is to ensure dynamism, productivity and competitiveness. In order to apply this, greater transparency about state aid and creating rules and processes that apply to it are needed. This is not to say that all subsidies to firms are bad but those that distort competition certainly are.

It remains to be seen whether the Ministry of Finance of Egypt would be entrusted with the supervision of state aid or should it be dealt with in the ECA, which, unlike the Ministry of finance, does not provide aid and as such is fully independent in its decision-making.

EUROPEAN UNION

1. Introduction: The rationale for European state aid control

The existing mechanisms and objectives of EU State aid control were laid down as early as 1957, in the original Treaty of Rome establishing the European Community. State aid control is an integral part of EU competition policy and a necessary safeguard to preserve effective competition and free trade in the single market.

When granting State aid, for instance by subsidising certain types of business activity (e.g. R&D), Member States aim to foster the economic or social development in their territories. State aid may contribute to creating or maintaining employment, lead to higher tax revenues or to additional economic growth for the Member State concerned. Likewise, State aid granted by national governments can influence firms' choices of production methods so that they become more environmentally friendly or more responsive to social needs.

However, when considering State aid measures, national governments may disregard possible negative spill-over effects on other countries. Member States may have incentives to use State aid strategically to promote national economic interests and develop activities on their territory, even though it may undermine the internal market and the common European interest. If State aid diverts similar activities elsewhere, it may be to the detriment of other Member States, and in particular to the detriment of less prosperous ones. Aid with such cross-border effects may trigger reactions by other Member States who might be tempted to retaliate by granting subsidies too. Such a subsidy race could lead to excessive amounts of aid, at the taxpayers' expense, and could seriously damage the internal market.

The Treaty on the Functioning of the EU thus establishes the principle that State aid which distorts or threatens to distort competition is prohibited in so far as it affects trade between Member States (Article 107 (1) of the Treaty on the Functioning of the EU, ex Article 87(1) EC).¹ However, State aid, which contributes to well-defined objectives of common European interest without unduly distorting competition between undertakings and trade between Member States, may be considered compatible with the common market (under Article 107(3) TFEU, ex Article 87(3) EC). The Commission assesses a wide range of aid targeted by Member States at objectives of common interest of economic and social development.

2. State aid procedures: Block exemption and notification

Before granting State aid, Member States need to obtain the authorisation from the Commission.² However, the majority of State aid measures are exempted from prior formal notification to the Commission. This mainly flows from the General Block Exemption Regulation which aims at the most

¹ In addition, subsidies granted by EU Member States may also be subject to international agreements, such as the WTO subsidies agreement.

² Aid amounts below € 200.000 over three years to a single undertaking are not considered to be State aid and thus need no authorisation by the European Commission, c.f. Commission Regulation (EC) No 1998/2006 of 15 December 2006 on the application of Articles 87 and 88 of the Treaty to de minimis aid, Official Journal L 379 of 28.12.2006.

obvious market failures and allows Member States – without prior notification – to take measures which with all probability would lead to limited distortions and for which the assessment criteria can be clearly articulated and implemented.³

Furthermore a lot of individual aid measures can be implemented under aid schemes: Once the terms and conditions of an aid scheme are approved by the Commission, individual aid measures falling under this scheme do not have to be notified any longer.

By this, the Commission can focus its assessment on large State aid cases coming with a high risk of competition and trade distortions. In terms of reported aid volumes (financial crisis measures excluded), such individual aid accounted in 2008 for only 5% of total aid to industry and services, with 75% being granted under approved schemes and 20% under block exemptions. In terms of the number cases, out of a total of 1000 Member State decisions in 2008 on schemes and ad-hoc cases, around 66% fell under the block exemptions (therefore had not to be notified), while 34% had to be notified to the Commission. This has reversed the ratio of two years before (40% vs. 66%).

A time limit of two months is set for the examination of notified individual aid or notified aid schemes after the receipt of all relevant information (preliminary investigation). If the Commission has doubts as to the compatibility of the aid project, it opens a formal investigation procedure so as to gather Member States' and interested parties' comments in an open and transparent way. However, the vast majority (92%) of all state aid cases are currently approved at the end of the preliminary investigation procedure without opening the formal investigation procedure.

In order to further streamline procedures, the Commission has just adopted a "simplification package", consisting of a Simplified Procedure and a Best Practices Code:

- The *Simplified Procedure*⁴ aims at improving the Commission's treatment of straightforward cases, like those clearly in line with existing Guidelines or established Commission decision-making practice. The Commission wants to ensure aid measures which are clearly compatible are approved within one month from a complete notification by a Member State. This procedure requires important adaptations to the working methods of both the Commission and Member States, the prerequisites for which (templates, standard decisions etc.) have been put in place. A transparency provision also ensures that third parties can provide input.
- The *Best Practices Code*⁵ details how all other State aids procedures should be carried out in practice. It includes a certain number of voluntary arrangements between the Commission and Member States to achieve more streamlined and predictable procedures, at each step of a State aid investigation. With better co-operation, the Commission hopes to be able to deliver State aid decisions within more business relevant deadlines.

Companies and consumers are also important players who may trigger investigations by lodging complaints with the Commission. Since 2002, DG COMP receives around 200 complaints annually. Complaints constitute an important source of information for the detection of unlawful aid.

When a negative decision is taken in cases of unlawful State aid, the Commission shall decide that the Member State must take all necessary measures to recover the aid from the beneficiary. It has to be

³ Official Journal, L 214, 9.8.2008, p.3.

⁴ Official Journal C136, 16.06.2009, p. 3-12.

⁵ Official Journal C 136, 16.06.2009, p. 13-20.

underlined that recovery has not to be conceived as a penalty, but as a means to restore the situation previous to the granting of the illegal and unlawful aid. This objective is obtained once the aid (plus compound interests) is repaid by the recipient who enjoyed an advantage over its competitors on the market.

A Member State is deemed to comply with the recovery decision when the aid (plus compound interests) has been fully reimbursed within the prescribed time limit or, in the case of an insolvent beneficiary, when the company is liquidated under market conditions. Where the Member State concerned has not complied with the recovery decision, and where it has not been able to demonstrate the existence of absolute impossibility, the Commission may initiate infringement proceedings before the European Court of Justice.

3. The compatibility assessment: basic principles and guidelines

3.1 *The balancing test*

When designing general State aid rules for cases that need to be notified, the Commission balances the negative effects on trade and competition in the common market with its positive effects in terms of a contribution to the achievement of well-defined objectives of common interest. Balancing these effects takes into account the impact of the aid on the social welfare of the EU. For that purpose, the Commission has established a "balancing test" which consists of the following elements:

- Is the aid measure aimed at a well-defined objective of common interest? (for example, growth, employment, regional cohesion, environment, energy security).
- Is the aid well designed to deliver the objective of common interest that is to say, does the proposed aid address the market failure or other objective?
 - Is State aid an appropriate policy instrument?
 - Is there an incentive effect, namely does the aid change the behaviour of undertakings?
 - Is the aid measure proportional, namely could the same change in behaviour be obtained with less aid?
- Are the distortions of competition and effect on trade limited, so that the overall balance is positive?

The first two questions address the positive effects of a State aid measure, whereas the third question refers to its negative effects on competition and trade and compares the positive and negative effects of the aid.

As regards the first question, the Treaty on the Functioning of the EU only provides for some exceptions to the general prohibition of State aid. It is thus necessary to first assess whether the objective pursued by the aid is indeed one that can be regarded as being in the common interest, and to assess the acceptability of that objective. Applying concepts developed in the economic theory, whether a measure contributes to an objective of common interest can be understood either in terms of its contribution to overall welfare and efficiency (does the State aid allow to remedy to a market failure) or in terms of equity (i.e. how is welfare distributed). All objectives of common interest can thus be described as contributing to efficiency and/or equity.

The second step is then to assess whether the aid is properly designed to reach the well-defined objective of common interest. More specifically, even if it addresses a well-defined objective, a particular State aid may not be an appropriate instrument. This would be the case where the State aid fails to deliver the desired objective or where other less distortive instruments achieve the same results. Further, the aid must actually induce the recipient to change its behaviour in such a way that the objective can be achieved. This condition would not be fulfilled in cases where the aid is not necessary because the beneficiary would achieve the objective even in the absence of aid. Finally, the aid amount should not exceed the amount necessary to achieve the objective.

The last question addresses the negative effects of State aid. Even if it is well-designed to address an objective of common interest, an aid given to a particular undertaking or economic sector may lead to an unacceptable degree of distortion of competition and of trade between Member States. The overall balancing requires not only to trace the effects of the aid on producers and on consumers in the Member States, but also to evaluate their magnitudes and to compare them subsequently. This implies for instance that negative effects of a considerable magnitude need to be offset by a corresponding high level of positive effects.

3.2 *Horizontal guidelines*

The general analytical principles of the balancing test as outlined above have been translated into a number of guidelines for specific aid categories, where the test has been adapted in the light of the specific policy and technical context. These rules explain in more detail under what conditions (e.g. eligible costs, intensity of aid, and nature of the beneficiaries) a Member State can grant aid to its undertakings. The rules cover a wide range of categories of aid: for example aid to research, innovation, environmental protection, regional development, development of SMEs, training, employment, risk capital, rescue and restructuring of firms in difficulty.

Box 1. Overview of most important non-sectoral state aid rules⁶

- Commission Regulation (EC) No 800/2008 of 6 August 2008 declaring certain categories of aid compatible with the common market in application of Articles 87 and 88 of the Treaty (General block exemption Regulation), Official Journal L 214, 9.8.2008, p. 3.
- Community Framework for State aid for Research and Development and Innovation, Official Journal C 323 of 30.12.2006, p.1.
- Community guidelines on state aid to promote risk capital investments in small and medium-sized enterprises, Official Journal C 194, 18.8.2006, p. 2.
- Community guidelines on State aid for environmental protection, Official Journal C 82, 1.4.2008, p. 1.
- Commission Regulation (EC) No 1628/2006 of 24 October 2006 on the application of Articles 87 and 88 of the Treaty to national regional investment aid, Official Journal L 302, 1.11.2006, p. 29
- Guidelines on national regional aid for 2007-2013, Official Journal C 54, 4.3.2006, p. 13.
- Criteria for the compatibility analysis of training state aid cases subject to individual notification, Official Journal C 188 of 11.8.2009, p.1.
- Criteria for the compatibility analysis of state aid to disadvantaged and disabled workers subject to individual notification, Official Journal C 188 of 11.8.2009, p.6.
- Community guidelines on State aid for rescuing and restructuring firms in difficulty, Official Journal C 244, 1.10.2004, p. 2.

⁶ These rules are available at http://ec.europa.eu/competition/state_aid/legislation/legislation.html.

Most of these guidelines and frameworks focus on areas where State aid alleviates market failures and helps to meet the challenge of sustainable growth (i.e. aid in the fields of research, training and risk capital or environmental aid). Other types of aid are rather aimed at equity issues (i.e. regional aid, aid to disadvantaged and disabled worker).

Aid for rescuing and restructuring firms has a particular role to play and rescue and restructuring operations have given rise to some of the most controversial State aid cases in the past and are among the most distortive types of aid. The main provisions of the Rescue and Restructuring guidelines ("R&R guidelines") will therefore be presented in more detail below.

3.3 *The Rescue and restructuring guidelines: Strict conditions*

The EU attaches strict rules regarding aid for rescue and restructuring for firms in difficulty. Aid to such firms may, however, be justified in exceptional circumstance, if there are countervailing benefits. Such benefits can be seen in the restoration of the long term viability of a firm in difficulty which may be desirable for employment or social considerations.

To assess a given rescue or restructuring aid measure the Commission developed the rescue and restructuring guidelines⁷ containing precise conditions to be respected by Member States when granting R&R aid. The guidelines ensure that the recourse to rescue and restructuring aid is linked to strict eligibility criteria, the most important of which is that the aid beneficiary has to be in difficulty.

There is no Community definition of what constitutes a firm in difficulty. However, for the purpose of the R&R guidelines, the Commission regards a firm as being in difficulty where it is unable, whether through its own resources or with the funds it is able to obtain from its owners/shareholders or creditors, to stem losses which will almost certainly condemn it to going out of business in the short or medium term without outside intervention by the public authorities. The guidelines spell out some specific objective criteria⁸: A firm is regarded as being in difficulty if more than half of its registered capital has disappeared and more than one quarter of that capital has been lost over the preceding 12 months. In the case of a company where at least some members have unlimited liability for the debt of the company, the same criterion is applied to its capital as shown in the company accounts. Whatever the type of company concerned, a firm is considered as being in difficulty where it fulfils the criteria under its domestic law for being the subject of collective insolvency proceedings.

Even when none of the circumstances set out in paragraph 10 of the R&R guidelines are present, a firm may still be considered to be in difficulties, where the usual indicators of a firm being in difficulty are present. The guidelines⁹ mention a number of such indicators. They include qualitative criteria such as increasing losses, diminishing turnover, declining cash flow, mounting debt, rising interest charges and falling or nil net asset value.

Legally, the R&R guidelines lay down the application of Article 107 (3)(c) TFEU, ex Article 87(3)(c) EC, in the particular case of firms in difficulty. On the basis of the Guidelines, State support for such firms may be found compatible with the EC Treaty.

⁷ See Community guidelines on State aid for rescuing and restructuring firms in difficulty (OJ C 244, 1.10.2004, p. 2).

⁸ See paragraph 10 of the guidelines.

⁹ See paragraph 11 of the guidelines.

This concerns first rescue aid in so far as the ailing firm is provided with ad hoc short term liquidity support to overcome acute financial shortcomings or restructuring aid in form of longer term support in order to redirect the company's operations. In the case of SMEs, rescue and restructuring aid may also be granted on the basis of schemes.

- Rescue aid can be provided for a period of six months to help the company cover its immediate liquidity needs and undertake other urgent structural measures. It is limited to temporary support to enable the ailing company to come up with a restructuring plan.
- Restructuring aid can be provided on the basis of a comprehensive restructuring plan with the aim to restore long term viability. The plan must define the restructuring period and the restructuring costs as well as the measures necessary to turn around the company. Such measures should imply operative, industrial and financial restructuring. The implementation of a sound restructuring plan is to ensure that the positive effects of the aid also materialise in the long term, as insufficient restructuring would just delay problems by a few years.

A further condition for the granting of restructuring aid is that the aid must be limited to the minimum necessary. To this end, a predetermined minimum threshold for private co-financing of the restructuring is introduced (the so called significant own contribution). As this own contribution normally requires the involvement of external financing it also ensures that the capital markets believe in the restructuring project's ability to restore long term viability. Limiting the aid to the minimum necessary avoids providing the company with surplus cash which could be used for aggressive behaviour in the market which is unrelated to the restructuring process.

In order to compensate for the distortion of competition caused by the aid, compensatory measures (e.g. divestment of assets, reductions in capacity or market presence and reduction of entry barriers on the markets concerned) must normally be taken.

Finally, the "one-time, last-time" principle ensures in cases of both rescue and restructuring aid that a firm that has received already rescue and restructuring aid in the last ten years is no longer eligible for any further aid. A firm has thus only one chance to restructure itself with the help of aid and the principle ensures that unviable firms are kept afloat through repeated injection of state aid.

The R&R guidelines were to expire on 9 October 2009. However, the economic crisis had created a difficult and unstable economic environment. Having regard to the need to ensure continuity and legal certainty in the treatment of State aid to enterprises in financial difficulty, the Commission decided to extend the validity of these guidelines until October 2012.¹⁰

4. The financial crisis: State aid control is part of the solution

Since October 2008, the financial and real economy crisis has been a major challenge for the field of State aid and has had a significant impact on the activity of the State aid network in terms of the number of cases that had to be assessed by the Commission: The scale and intensity of the crisis in the financial markets and its potential impact on the overall economy of Member States put governments throughout the EU under huge pressure to provide a wide range of support measures to assist vulnerable financial institutions in order to safeguard the stability of the financial system and to assist companies in the real economy.

¹⁰ Official Journal C 156 of 9.7.2009, p.3.

In view of the exceptional circumstances, there had even been calls for the Commission to considerably “relax” or even “suspend” EU disciplines in the area of State aid, at least as long as the financial crisis lasts. This has, however, never been an option. On the contrary, EU competition policy proved to be an integral part of the solution to the problems stemming from the crisis. Abandoning EU competition discipline at this time of crisis would have risked a disintegration of the European Single Market. Rather than abandoning competition rules, the Commission has found that State aid rules have enabled it to support solutions for stabilising European banks, while at the same time guaranteeing the common European interest.

4.1 Commission response to the financial sector crisis

Following the deepening of the financial crisis in the autumn of 2008, the Commission swiftly provided guidance in the form of Communications on the design and implementation of State aid in favour of banks.¹¹ In these Communications, the Commission recognised that the severity of the crisis justified the grant of aid on the basis of Article 107(3)(b) TFEU¹², ex Article 87(3)(b) EC, and set out a co-ordinated framework for the provision by Member States of public guarantees, recapitalisation measures and impaired asset relief, whether to individual banks or as part of a national scheme. The primary rationale of the guidance in these Communications was to ensure that emergency measures for reasons of financial stability guarantee a level playing-field between banks located in different Member States as well as between banks who receive public support and those who do not. On the basis of this guidance, the Commission has since October 2008 approved on a temporary basis a large number of schemes under State aid rules.¹³

The Commission also had (and still has) to deal with a large number of individual cases of bank restructuring, which follow from bank rescue aid measures approved on the condition that a restructuring plan would be submitted within six months. In order to foster transparency, predictability and equality of treatment between Member States, the Commission issued guidelines to clarify its approach, the criteria it will base its assessment upon and the type of information required to guide this assessment.¹⁴ These guidelines are based on Article 107(3)(b) TFEU, ex Article 87(3)(b) of the EC Treaty. They will be temporary and apply until the end of 2010. After that date, the normal rules on rescue and restructuring, based on Article 107(3)(c) of the Treaty should resume (see point 3.3. of this paper).

¹¹ See Communication from the Commission – The application of State aid rules to measures taken in relation to financial institutions in the context of the current global financial crisis, OJ C 270, 25.10.2008, p. 8 (“the Banking Communication”); Communication from the Commission – The recapitalisation of financial institutions in the current financial crisis: limitation of aid to the minimum necessary and safeguards against undue distortions of competition, OJ C 10, 15.01.2009, p. 2 (“the Recapitalisation Communication”); Communication from the Commission on the Treatment of Impaired assets in the Community Banking Sector, OJ 72, 26.03.2009 (“the Impaired Assets Communication”).

¹² Article 107(3)(b) allows aid “to remedy a serious disturbance in the economy of a Member State”.

¹³ On 7 August 2009 DG Competition has published a review of the existing national guarantee and recapitalisation schemes: see DG Competition’s review of guarantee and recapitalisation schemes in the financial sector in the current crisis (“Review paper”) published on http://ec.europa.eu/competition/state_aid/legislation/review_of_schemes_en.pdf.

¹⁴ Commission communication on the return to viability and the assessment of restructuring in the financial sector in the current crisis under State aid rules, OJ C 195, 19.08.2009, p.9 (“the Restructuring Communication”).

4.2 *Commission response to the real economy crisis*

As a consequence of the crisis in financial markets, banks had become much more risk averse than in previous years, and as a result much less willing to provide financing to the real economy. This credit squeeze not only affected weak companies, but also healthy companies which found themselves facing a sudden shortage or even unavailability of private funding, whether loans or risk capital.

Therefore, in addition to the communications on State aid to financial institutions in response to the financial crisis, in December 2008 the Commission also adopted a "Temporary Framework for State aid measures to support access to finance in the current financial and economic crisis" in response to the growing effects of the crisis on the real economy.¹⁵

The Temporary Framework provides for a number of new measures that can be applied by Member States for a limited period of time, until the end of 2010, as well as a number of limited temporary derogations from existing State aid rules. It should be noted that the Temporary Framework in principle of general application to all types of firms. However, a significant exception is that it is not applicable to firms that were in difficulties before 1 July 2008. Companies whose difficulties date from before the credit crunch must address their structural problems exclusively on the basis of the general rules regarding rescue and restructuring aid, as described in point 3.3 of this paper. The rule acknowledges that a number of companies may find themselves cut off from financing due to the drying up of the lending market, although they have a sound business plan. The Temporary Framework is therefore applicable to relieve their temporary financial difficulties. If the aid provided under the framework is not sufficient to address these difficulties, it can mean that the company has more structural problems, in which case the normal rules of rescue and restructuring aid will have to be applied. This set of rules regarding firms in difficulties is precisely devised to ensure that over-protective aid measures devised by the Member States would not revitalise structurally failing firms to the detriment of competition and healthier firms.

4.3 *Exit and the return to a "pre-crisis" scenario*

As a matter of fact, the new rules were to be seen as a temporary adaptation of existing State aid rules that target the specificities and the expected temporary nature of the credit squeeze while fully respecting the general principles and philosophy of the balancing test. Furthermore it needs to be stressed that the existing State aid tool box already provides a good basis for the Member States' response to the crisis along the lines in the European recovery plan, in particular as regards the focus on smart investments.

A key challenge will now be to secure the return to viability of the financial sector and the phasing out of State support in the context of an overall coordinated exit strategy. In this context, it will be crucial to develop a coordinated approach, which takes account of financial stability and individual Member States' circumstances and provides adequate incentives for financial institutions to cease to depend on public financial support.

5. **Some statistics**

Total State Aid granted by Member States¹⁶ stood at € 279.6 billion in 2008 or 2.2 % of the EU Gross Domestic Product (GDP). Aid measures implemented by Member States in response to the financial crisis ("crisis aid") amounted to € 212.2 billion or 1.7% of GDP.

¹⁵ Official Journal C 16, 22.1.2009, p. 1.

¹⁶ The total covers aid to manufacturing, services, coal, agriculture, fisheries and part of the transport sector but excludes aid to the railway sector, aid for compensation for services of general economic interest due to

When excluding crisis aid, total State aid amounted to € 67 billion in 2008 or 0.54% of GDP. Almost € 53 billion or 0.42 % of GDP were directed towards industry and services (of which € 2.7 billion to the coal sector), while aid to agriculture amounted to about € 11.8 billion, aid to transport (with the exception of railways¹⁷) to € 2.4 billion and aid to fisheries to € 0.34 billion.

During the more favourable economic climate, there was a downward trend of State aid for industry and services from € 55 billion (or 0.5 % of GDP) in the period 2002-2004 to € 50 billion (or 0.4 % of GDP) in the period 2005 – 2007, a marked decrease from rates of around 2% in the 1980s and 1% in the 1990s. In 2008, it slightly increased by 0.04%.

The overall EU share of aid earmarked for horizontal objectives of common interest increased from 74 % in 2003-2005 to 85 % in 2006-2008. Taken together, the three most frequently used horizontal objectives in 2008 were: regional development (€ 14 billion) environmental aid (€ 13 billion), aid for R&D (€ 9 billion) account for 66% of total aid to industry and services. In comparison, aid for rescue and restructuring accounted in 2008 for about 2 % (0.6billion) of total State aid to industry and services.

6. Conclusion

The EU State aid control policy has played an essential role in the preservation of competition and free trade within the single market and in the promotion of the competitiveness of the EU economy.

Of course, the effectiveness of the European Commission's control of State aid granted by Member States is made easier by the supranational nature of the European Union: EU law has superiority over national law, and Commission's decisions are binding on Member States. In addition, the European Commission is independent from the national governments, and as a result, it does not hesitate to order recovery of unlawfully granted State aid.

This, however, does not mean that State aid control should be the monopoly of institutions like the European Commission. There are examples which show that such a control can be exercised at a horizontal level, within a national framework. Thus, the candidate countries that aspire to become members of the EU must set up some form of State aid control a few years before they join the Union. As a result, they entrust an authority, usually their competition agencies, with the task of reviewing the aid granted by the different levels of their public authorities. This system is generally effective and ensures that these countries' companies are already used to the application of the strict EU State aid rules before they become

Therefore, and to conclude, State aid control is an option which can usefully and realistically be considered by other States, outside the EU.

the lack of comparable data. See Autumn Scoreboard 2009 update: COM(2009) 661, 07.12.2009 and Commission Staff working document "Facts and figures on State aid in the EU Member States", SEC (2009) 1683, 07.12.2009.

¹⁷ A large amount of public financing for railways is not notified to the Commission, either because the financing, due to the lack of liberalisation of the sector, is not deemed by Member States to constitute State aid within the meaning of Article 87(1) of the EC Treaty, or because it is exempted from notification in accordance with Regulations 1191/69 and 1192/69. Member States are however required to report to the Commission overall public expenditure to this sector.

FORMER YUGOSLAV REPUBLIC OF MACEDONIA

1. The use of state aid in the Republic of Macedonia

In the Republic of Macedonia there is no particular sector affected by the grants or tax breaks. Tax breaks have been given several times, but to all companies as general measure of the Government, so it could not be defined as State aid according to the Law on State Aid.

Selling of land owned by the State at a price below market level on 2 occasions has been treated by the Commission for Protection of Competition (CPC) as an unlawful aid, and as such asked with decision to be recovered.

Due to scarcity of sources of the State, very small difference between normal market rate and below-market rate, as well as harsh procedure to obtain soft loans, the granting of loans at below-market rates supposes to be so called *de minimis* aid (up to Euro 100.000 per undertaking in three consecutive years in existing Law on State Aid).

Attracting firms to economically distressed regions in a form of investment aid is primary goal of the Government as major State aid provider. The Government established scheme for providing regional aid on the basis of the Law on Technological Industrial Zones, and notified it to the CPC.

There have been also cases of support to companies that are performing services of general economic interest. Most of these cases have been regularly notified to the CPC. In this field, Macedonian State aid legislation is fully aligned with the legislation of the European Union (*acquis communautaire*).

Macedonian legislation and practice treat equally domestic and foreign companies.

So far, there have not been cases of remedying competition distortion created by the granting of aid by foreign governments, nor preventing strategic firms from being purchased by foreign companies. Moreover, the intention to attract more foreign investors pushes the aid in rather opposite direction.

Until the crisis, but also beyond it, companies had not suffered undersupply of credit by the financial sector. But the relative high market rate of the loan and crisis in real sector, forced the Government to help companies with loans which are at slightly lower rate than normal market rate.

The Macedonian Law on Public Procurement is fundamentally aligned with the *acquis*. A unified nomenclature for public tenders above certain thresholds is obligatory for all State institutions and all public companies. Standard tender documentation and user-friendly manuals are available on the website of the Public Procurement Bureau. There is also an established remedies system through the State Appeals Commission. Contracting authorities increasingly are using the e-procurement system.

Licenses to operate a mobile telephony network have been provided by the Agency for Electronic Communications. There are 3 mobile operators in Macedonia. It has provided also 2 licenses for 3G and for radio frequencies for broadband wireless internet access. Agency for Electronic Communications fully cooperates with CPC in order to prevent distortion of competition on this market.

Licenses to operate a television network are provided by the Broadcasting Council. Competition on the electronic communications markets increased as a result of the liberalisation process, to the benefit of consumers.

Access to natural resources is regulated by the Law on Concessions and other Types of Public-Private Partnership of 2008. Responsible institution for licenses for concessions is the Ministry of Economy.

2. Aid to ailing companies, especially in the context of the financial crisis

Aid to ailing companies in Macedonian State aid legislation is regulated in the Regulation on Establishing Conditions and Procedure for Granting Aid for Rescue and Restructuring of Firms in Difficulties; (Official Gazette of Macedonia No. 81/03 and 83/07).

This Regulation is aligned with the Community guidelines on State aid for rescuing and restructuring firms in difficulty (2004 OJ C 244/2).

Financial crisis has not affected Macedonian financial sector, so no specific rescue measures have been undertaken for banks and other financial institutions.

Also, there has not been aid to industrial firms, nor to particular industry.

A firm qualifies to use this kind of aid, if it is unable to meet its obligations through its own resources with the funds it is able to obtain from of its owner/shareholders or creditors to stem losses which, without outside intervention by the public authority will almost certainly condemn it to go out of business in the short and medium term. Rescue aid and restructuring aid can be provided only as a loan or loan guarantee on “one time last time principle” which means that one company can only once in 10 years receive rescue aid. In case of loan, the loan shall be repaid over a period of not more than 6 months following the last instalment paid to the firm.

The provider of the aid should inform the CPC for a restructuring or liquidation plan of the firm not later than 6 months after the rescue measure has been authorised or proof that the loan has been reimbursed in full, and/or the guarantee has been terminated.

The aid is restricted to the amount needed to keep the firm in business for at the period during which the aid is authorised (covering, e.g. wage and salary costs and routine supplies).

Compensatory measures should be taken as a rule to mitigate any adverse effects of the aid on competitors. These measures usually consist in restrictions on the presence of the firm on its market(s) during and after the period of restructuring, and:

- Shall be implemented through the restructuring plan and conditions attached to it;
- Must make a contribution (in proportion to the amount of aid received and its impact on that market) to the improvement of market conditions;
- Above mentioned measures shall not be requested for small and medium-sized enterprises, except in case otherwise stipulated by the State aid rules for certain sector.

Restructuring aid should normally only be used to restore the firm’s viability but not enable the firm to extend its production capacity during the implementation of the restructuring plan, except in cases when such extension is essential for restoring viability an undue distortion to competition.

It is requested that the aid beneficiary makes a significant contribution to the restructuring plan from its own resources, including selling a property which is not essential for the surviving of the company, or by financing from other sources under market conditions. This contribution must be realistic and to exclude expected profit as a cash flow and it should be higher as possible. It is considered that following contribution rates are appropriate: at least 25% in the case of small companies, at least 40% in the case of medium-sized companies and at least 50% in the case of large companies.

Sometimes the aid to ailing companies takes the form of temporary government ownership. So far, cases of such changing of ownership have been done on the market principles. There are not examples where government turns a profit after the aided firm's situation improved.

Until now, no rescue and restructuring aid has been provided in the meaning of the Law and the Regulation.

3. Legal restrictions on state aid

By definition in the existing Law on State aid, any State aid, irrespectively whether it is granted under an aid scheme or as an individual aid award, which distorts or threatens to distort competition by favouring certain undertakings or certain products, is incompatible with the Law insofar as it may affect trade between the Republic of Macedonia and the European Community, which means, that, by virtue, State aid is forbidden.

Besides of the Law on State Aid, Macedonian State aid legislation consists of 4 Regulations. One of these Regulations is Regulation on Establishing Conditions and Procedure for Granting Horizontal Aid. (Official Gazette of Macedonia No. 105/07)

This Regulation regulates, inter alia, aid for the activities of researching, development and innovation. It may be considered compatible if it refers to one or more of the following categories of research:

- Fundamental research (aid intensity 100% from eligible costs);
- Industrial research (aid intensity 50% from eligible costs);
- Experimental research (aid intensity 25% from eligible costs).

This kind of aid may be granted only if before the beginning of the project application has been made from the beneficiary to the aid provider. In all cases, providers of aid must before the CPC demonstrate incentive effect from the measures by preceding evaluation for increasing activities for researching, development and innovation. But for SME's and where the amount of aid is below Euro 3.75 million per enterprise, for industrial property rights costs for SME's, for young innovative enterprises, for advisory services, innovation support services and for loan of highly qualified personnel these determinations do not apply.

The Republic of Macedonia is Member State of CEFTA. The provisions of CEFTA Agreement in the field of competition and State aid are actually transposed from Articles 101, 102 and 107 of TFEU. So far, supranational control mechanism foreseen in CEFTA Agreement in the field of competition has not been used.

One of the tasks of the CPC is to monitor all State aid provided in the Republic of Macedonia, except State aid granted in the sector of agriculture and fisheries.

Until now, there is no reported case when private company complained about predatory strategies or unfair practices implemented by either public or private company benefitting from public funds.

There has been one case when company complained about discriminatory treatment, in comparison to a competitor benefitting from State aid in the form of purchasing of State owned land below market price. The CPC assessed this aid as unlawful and asked for recovery, i.e. full market price of the land to be paid by the aid beneficiary.

In the price regulated sectors, the CPC deals according to its authorisation and according to signed Memoranda of Understanding with regulators. However, there has not been reported case involving State aid in regulated sectors.

So far, the CPC have not had any case of abuse of dominance or merger affected from the State aid.

In Macedonian Constitution, public and private ownership are equal. So, there is no such discrimination in Macedonian competition legislation.

According to its Stabilisation and Association Agreement with the European Union, and its Interim Agreement of 2001, Macedonia committed to implement competition and State aid legislation until 2006. By adopting and implementing both legislations, the Republic of Macedonia fulfilled its obligation and now has functional competition and State aid legislation.

The Republic of Macedonia has State aid legislation since 2003. It is aligned with the State aid legislation of the European Union. However, despite clearly defined obligations for State aid providers, results of the implementation of the legislation in the first three years (2003-2006) could be defined as modest and without rising of any public awareness for existing of this kind of legislation.

With the amendments of the Law in 2006, monitoring of aid, as well as power to issue decisions on compatibility of State aid, transferred to the Commission for Protection of Competition (in further text CPC).

In last three years, monitoring of aid became more comprehensive, mostly as a result of much better cooperation of the CPC with the State aid providers. Every major State aid provider appointed person in charge to notify State aid provided by the corresponding provider. Since 2007, the Manual of the Government foresees obligation for all governmental institutions by submitting documents to the Government to declare if there is State aid in submitted document, and in the case of positive answer, to provide decision or opinion of the CPC.

It can be concluded that permanent advocacy on State aid among governmental bodies contributed to much better understanding of the notion of State aid among State aid providers. There is no doubt that proper implementation of the State aid rules, together with the competition rules, makes use of public funds more efficient in order to remedy eventual distortion of competition, but also to intensify economic activities where appropriate.

INDIA

State-Aid and Subsidies are the policy instruments which Sovereign Governments consider as vital development tools available with them to achieve various national goals. Although they may lead to certain unintended economic effects and inefficient allocation of resources in a competitive market and may fundamentally act against the functioning of open markets and liberalisation of international trade, State aid and Subsidies may also contribute to the correction of market failures or market imperfections. They often produce externalities¹ which may sufficiently achieve the objectives of prevention of distortion of competition; factors that ought to be considered in determining the compatibility of state aid measures and subsidies with the market.

This paper discusses subsidies as part of state-aid measures which have been undertaken in India in the recent years.

Generally, subsidy is considered as financial contribution that is paid by a government or an organisation to reduce the cost of services or cost of producing goods so that their prices can be kept low. On an international level, unfair trade practices such as subsidies were identified as a threat to open markets as early as 1947, when the first GATT agreement was signed. In framework of WTO, *Agreement on Subsidies and Countervailing measures* has defined subsidy as:

- A financial contribution by a government or public body within the territory of the country where:
 - There is a direct transfer of funds (e.g. grants, loans and equity infusion) and potential of funds or liabilities (e.g. loan guarantees);
 - Government revenue that is otherwise due is foregone or not collected (e.g. fiscal incentives such as tax credits, income tax exemptions etc);
 - When a government provides goods and services at a preferential price other than general infrastructure;
 - A government makes payments to a funding mechanism, or entrusts or directs a private body to carry out, one or more of the type of functions which would normally be vested in the government.
- Any form of income or price support;
- Any benefit given by a government to an exporter that provides an unfair advantage to the exporter in international markets.

¹ Employment aid, environmental aid, aid for research and development, regional aid are some of the instruments which may be taken as positive externalities.

Thus for a subsidy to exist there must be a financial contribution by the government and a benefit be conferred thereby.

Subsidies may have different forms. The various alternative modes of administering a subsidy may include grant of subsidy to producers and consumers, subsidy to producers of inputs, production/sales through public enterprises, cross-subsidisation etc. A cash payment to producers/ consumers is an easily recognisable form of a subsidy. However, it also has many invisible forms like reduced tax-liability, low interest government loans or government equity participation. Subsidies are implied if the government procures goods, such as food grains, at higher than market prices or if it sells as lower than market prices.

1. Subsidies in India and Competition Act, 2002

Although there is no specific mention of state aid measures or subsidies and their treatment under the competition law in India, the Competition Act, 2002, defines enterprise to include Govt. Departments except when engaged in the discharge of sovereign functions. Subsidies have proliferated in India due to several factors like spread of governmental activities, relatively weak determination of government to recover costs from the respective users etc. It has been recognised² that market mechanism often results in under consumption of goods and services by the vulnerable sections of essential commodities, either because of their high prices or because of the competing claims of other goods and services on their incomes and by reducing the price of the identified goods for identified sections of the society, subsidies increase affordability, improve access and correct the under consumption of these goods with positive externalities.

Studies³ have shown that central government subsidies were at 4.25% of GDP in 2002-03 and 4.18% of GDP in 2003-04 accounting for 72.32% and 87.68% of fiscal deficit, respectively. Bulk of the Central Govt.'s subsidies in India arise on account of the provision of economic services with very low recovery rates with subsidies on non-merit goods exceeding those on merit goods. The most important explicit subsidies administered through the Central Government budget are food and fertiliser subsidies. In states, one-third of total subsidies are directed towards merit goods. Subsidies in social services and economic services constitute bulk of the total subsidies and the proportion of merit subsidies is much higher in social services vis-à-vis economic services. Subsidies to States' public enterprises are large but recovery in the form of interests and dividends is extremely low indicating general trend towards low recovery.

In the context of their economic effects, subsidies have been subjected to an intense debate in India in recent years. Apart from issues like magnitude and incidence of subsidies- both explicit and implicit, their burden on government finances, target group of such subsidies and their injurious effect on general economic growth of sectors have also been in the realm of discussion.

2. Recent Trends

The total Central Govt. expenditure on subsidies increased from Rs.47,522 crore in 2005-06 to Rs. 1,29,243 crore in 2008-09 as per revised estimates. Out of this, expenditure on major subsidies accounted for Rs. 44,480 crore in 2005-06 which has gone up to Rs.1,22,728 crore in 2008-09 as per revised estimates and has been budgeted at Rs.1,06,004 crore in 2009-10. *Among the major subsidies, Food subsidy* is provided to meet the difference between economic cost of food grains and their sales realisation at Central Issue Prices fixed for Targeted Public Distribution System (TPDS) and other welfare schemes. In addition, the Central Government also procures food grains for meeting the requirements of buffer

² The Economic Survey, Ministry of Finance, Govt. of India, Year 2008-09, pp. 45-46.

³ Analysis provided by the Finance Ministry in its Report prepared with assistance from the National Institute of Public Finance and Policy ("Central government subsidies in India: A report", December 2004).

stock. Hence, part of the food subsidy also goes towards meeting the carrying cost of buffer stock. A retention price scheme for indigenous fertilisers is in operation since 1977. Under Indigenous (Urea) Fertiliser subsidy scheme it is intended to make fertilisers available to the farmers at reasonable prices and to give producers of fertilisers a reasonable return on their investment. The difference between the concession price so fixed, less distribution margin and the statutorily controlled consumers' price is allowed as subsidy. As indigenous production is not adequate to meet the demand for fertilisers, imports are arranged to make up the shortfall. Mainly three varieties of fertilisers, viz. Urea, Di-ammonium phosphate (DAP) and Muriate of Potash are imported. As only Nitrogenous fertilisers are under price control, the estimates of subsidy under imported subsidy are based on the likely imports of urea during the year. The provision of 'sale of decontrolled fertilisers with concession to farmers' relates to payments to manufacturers/importers of fertilisers/agencies. The scheme was introduced after the prices of phosphatic and potassic fertilisers were decontrolled, with a view to enable farmers to maintain a healthy N:P:K ratio and contain prices of fertilisers.

Interest on loans sanctioned by the Government is normally payable at the rates prescribed from time to time. In specific cases where a concession is allowed in the rate of interest or where exemption is given from payment of interest on the loans, subsidies are paid and an amount equal to the subsidy is taken as interest receipt of the Government.

Subsidies are also paid towards other items like support for Market Intervention/Price Support Scheme for agricultural produce, maintenance of buffer stock of Sugar (for meeting outstanding claims of sugar mills for maintenance of buffer stock of sugar), reimbursement of internal transport charges to sugar factories on export shipment of sugar, extending financial assistance to Sugar Undertakings, import of edible oils, import of Pulses, payment to Shipyards etc.

Table 1. Subsidy payments⁴ during 2005-06 to 2008-09 at a glance are given as under

Details of subsidies	In Rs.crore				
	2005-06	2006-07	2007-08	2008-09 (RE)	2009-10 (BE)
A. Major subsidies	44480	53495	67498	122728	106004
1. Food	23077	24014	31328	43627	52490
2. Indigenous(Urea)Fertiliser	10653	12650	12950	16517	9780
3. Imported (Urea) Fertiliser	1211	3274	6606	10981	5948
4. Sale of decontrolled fertiliser with concession to farmers	6596	10298	12934	48351	34252
Total Fertiliser Subsidy	18460	26222	32490	75849	49980
5. Petroleum subsidy	2683	2699	2820	2877	3109
6. Grants to NAFED for MIS/PPS	260	560	860	375	425
B. Other Subsidies	3042	3630	3428	6515	5272
7. Import/Export of sugar Edible Oils etc.				540	200
8. Interest Subsidies	2177	2809	2311	4063	2601
9. Other Subsidies	865	821	1117	1912	2471
Total-Subsidies	47522	57125	70926	129243	111276

⁴ Budget Documents, Ministry of Finance, 2009-10.

3. Tax Concessions⁵

Subsidies to preferred taxpayers are given as tax preferences in budget. Such implicit payments are referred to as “tax expenditures”.

The table given below gives details of revenue foregone for the year 2007-08 and 2008-09.

Table 2. Revenue foregone in financial year 2007-08 and 2008-09 (in Rs. crore)

	Revenue Foregone in 2007-08	Revenue foregone as a percentage of Aggregate Tax Collection in 2007-08	Revenue Foregone in 2008-09	Revenue foregone as a per cent of Aggregate Tax Collection in 2008-09
Corporate Income-tax	62199	10.5	68914	11.36
Personal Income-tax	38057	6.43	39553	6.52
Excise Duty	87468	14.77	128293	21.16
Customs Duty	153593	25.95	225752	37.23
Total	341317	57.67	462512	76.28
Less export credit related	56265	9.5	44417	7.32
Grand Total	285052	48.16	418095	68.95

Revenue Foregone on account of Export Promotion Concessions was estimated to the tune of Rs. Rs. 44417 crore in the year 2008-09 as against 56265 crore in the year 2007-08.

Subsidies have the potential to lead to perverse economic effects which would result in inefficient resource allocation where market imperfections do not justify a subsidy, by diverting economic resources away from areas where their marginal productivity would be higher. The unfair competition between subsidised goods of one country and similar non-subsidised goods of another country could arise in any of the markets; (i) the market of the subsidising country; (ii) market of the country importing the subsidised product; or (iii) a third country market. The WTO agreement covers within its framework mechanism to take action against such subsidies.

Subsidies are used to promote a wide variety of government policies and address a range of market failures. An unintended consequence of subsidies is that these can distort competition between firms undertaking similar activities, particularly when subsidies are large and only available to a select group of the firms that compete with each other. Efficient competitive markets are created by a process of rivalry and competition between firms. Competition, through efficient markets, delivers lower prices, greater choice and more popular products to consumers. The provision of subsidies to a recipient will impact on the recipient's costs and so will affect its decisions concerning what, how much and how to produce, and what to charge for it. If a subsidy recipient's actions are affected, competing firms may also adjust their behaviour. Giving some firms an advantage over their competitors may give rise to abusive behaviour since as a result of the subsidy the recipient increases its market share to a level at which it has power to behave independently of competitive pressures.

Subsidies that are closely targeted at the particular policy objective would be less likely to have a significant effect on competition. Characteristics like size of subsidy, target of subsidies, effects on costs, market concentration, level of product differentiation, barriers to entry and exit, effects on input markets are some of the factors that will enable the assessment of subsidy from the point of view of competition.

Concerns have also been raised about the widespread use of subsidies particularly domestic farm subsidies by developed countries. Farm subsidies distort the production structure of a country by raising crop prices in a country's internal market. Overproduction and stagnant demand for agricultural goods lead

⁵ Statement on tax expenditure or revenue foregone was first laid before the Parliament during Budget 2006-07.

to surpluses in these countries which squeeze out imports in the already restricted domestic markets. The surplus is also dumped in the international market at a cheaper rate causing price suppression of that commodity in the international market. Export subsidies are eventually used to cover the price difference between high domestic prices and lower international prices.

Subsidies are an important policy tool that can bring about improvements in welfare. In particular, subsidies that address market failures can bring about economic growth. However, subsidies also place costs on the economy. Competition among firms helps markets to function effectively, rewarding efficient firms that direct resources to the use most valued by consumers. Changes in market outcomes could affect allocative efficiency since resources may not be employed in the most efficient way possible. It may affect productive efficiency since goods may not be produced as efficiently as they could be and finally it may also impact dynamic efficiency affecting innovations.

Competition, through efficient markets, delivers lower prices, wider choice and more popular products to consumers. In competitive markets, firms seek to bring products to market which are more valued by consumers than those of their competitors at a lower cost. Firms that consistently fail to deliver products that consumers want and at prices they are willing to pay, will be forced out of the market to be replaced by more proficient firms. In this way, competition encourages the economy to be efficient and to produce the goods most valued by consumers using the least possible resources.

Most of the Indian manufacturing sector depended on "subsidies" of a different kind for several decades up to the early 1990s. High tariffs and import controls protected manufacturing units from cheaper imports and the Indian consumer paid the subsidy through inflated prices for domestic manufactures. As trade protection was gradually and systematically reduced, these subsidies disappeared. Indian industry also reacted positively by becoming more efficient, resilient and dynamic.

The macroeconomic costs of unjustified subsidies are reflected at present in large fiscal deficits in India. Justification for overall cutbacks in subsidies, regardless of their effects on the poor and needy has been recognised as an important fiscal policy agenda. Realising this Economic Survey for the year 2008-09 brought out by the Ministry of Finance, Govt. of India has underlined the need for reforms in subsidies. Any agenda discussion on subsidy in India must focus at placing systems for periodic review of existing subsidies, setting clear limits on duration of any new subsidy schemes and ultimately reducing the overall scale of subsidies considering that it is competition in the market which will ensure survival of more efficient firms, delivering benefits to the consumers and ushering economic efficiencies in the markets place.

JORDAN

1. Introduction

In the context of global economic shifts, and to be able to face the challenges arising there from and keep up with rapid changes, the Hashemite Kingdom of Jordan joined some global economic communities and applied economic corrective programmes, which collectively led to the liberalisation of the markets, the removal of trade barriers and the activation of the private sector's role.

In order to keep pace with these challenges, the policies that seek to establish economic freedoms and support market mechanisms had to be implemented.

Attaining a comprehensive policy to regulate competition is considered an effective instrument to protect the economic activities in Jordan, and is a cornerstone for a sustainable economic development and growth, and for ensuring transparency and integrity in all active institutions in the Market. The Competition policy and regulations can enhance the competition among institutions to allocate resources effectively, and to increase the community's economic welfare by the provision of the necessary goods to consumers at reasonable prices and high quality.

Activating market competition will contribute to the stability of goods' prices, guarantees a balanced market, and enhances the economic performance. Maintaining a high level of competition in the domestic market would raise the economic performance, and improve the competitiveness of the local institutions on the international level. Conversely, the anti-competitive practices performed by monopolist institutions will minimise the economic efficiency, disperse the resources, deepen the economic deformities, and decrease the motivations to creativity and innovation.

Accordingly, Jordan has become the first Arab State in the Middle East to adopt a national law to regulate the competition. The Competition Law no. (33) of 2004 was enacted as a permanent law on September 2004.

To ensure a successful execution of the competition policy and Law, and believing that there should be a special regulation to control competition in the modern economic regulations scheme to protect the investors from the negative impacts of the control of the dominant institutions, and to eliminate the restricting practices that minimise the freedom of economic activity. Thereupon, the Ministry of Industry and Trade established the Competition Directorate and incorporated it in the Ministry's organisational structure, supporting it with specialised cadres. The Directorate organised several awareness campaigns that aim to promote the competition culture and introduce the provisions of the Competition Law and its areas of application. In addition, the competencies responsible for implementing the Competition Law were qualified through a number of in-house and abroad specialised courses on competition.

2. Jordan's international commitments

- The Euro-Jordanian Association Agreement (article 53);
- A free trade area with the US;
- The Pan-Arab Market (The Arab Competition Regulations);

- Accession to Greater Arab Free Trade Area;
- The World Trade Organisation Treaty.

The law is based on free determination of prices in accordance with market mechanisms and principles of free competition, except for:

- Prices of basic commodities such as bread and fuel that are regulated by other laws;
- Temporarily price controls set by the government to cope with exceptional circumstances.

The law seeks to further free economic activities:

- Freedom to enter a market (entry barriers);
- Freedom to exit a market (exit barriers).

3. Competition directorate

For the purpose of implementing the Competition Law, the Competition Directorate was established by the end of 2002 as a part of the Ministry of Industry and Trade, and it was the entrusted authority with implementing the Competition Law.

- The Competition Directorate tasks are:
 - Spreading the Competition Culture;
 - Setting Jordan's Competition Policy;
 - Conduct the necessary investigations of practices that may contravene competition;
 - Receive complaints and requests for economic concentration activities and exemptions and following them up;
 - Co-operate with similar entities outside the Kingdom for the purpose of exchanging information and data and in relation to the execution of competition rules to the extent permitted by international treaties;
 - Issue clarifying opinions in competition matters.

4. WTO and EU Commitments

- Jordan Accession to the WTO was on February 24th 2000 and Jordan became officially the [136th WTO Member](#) on April 11th 2000.
- As a result of joining WTO, Jordan liberalised its services sectors providing market access to foreign investors and service providers of WTO Members in accordance with Jordanian laws and regulations.
- The [Association Agreement](#), which entered into force on 1st June 2002, aims to create a free trade area between EU and Jordan by the year 2010, as well as to establish a comprehensive framework for political, trade, economic and financial co-operation.

5. EU-Jordan Association Agreement / Chapter 2 Competition and other economic matters

- Article (53);
- Provision (1) the following are incompatible with the proper functioning of the agreement in so far they may affect trade between the community and Jordan:
- Provision (1)

Subparagraph any public aid which distort or threaten to distort competition by favouring certain undertaking or the production of certain goods;
- Provision (4)

Subparagraph (b): Each party shall ensure transparency in the area of public aid inter alia by reporting annually to the other party on the total amount and the distribution of the aid given and by providing upon request information on aid schemes upon request by one party the other party shall provide information on particular individual cases of public party.

6. Competition law of Jordan and state aid

- Competition Law of Jordan has no provisions on state aid;
- Due to Jordanian government budget financial challenges, the state aid is not significant;
- Jordan reduced its total domestic subsidies offered by the government to local agricultural producers by 13.3% out of JDs (1,539,199) over a period of seven years as of date of joining WTO;
- The ceiling of agriculture exports subsidies has been fixed at 0%;
- Export subsidies in the industrial sector which are considered prohibited under WTO agreements, a special programme by the Central Bank of Jordan to subsidise exports loans' interests was cancelled by December 31st, 2002;
- Due to Jordan's commitments under the WTO, the exemption of profits resulting from exports from income tax ended by the end of the year 2007.

7. State aid programmes in Jordan

In light of global economic developments, the challenges that are facing the industrial and services sectors and especially those related to technology transfer and capacity building. These called on the government and through Jordan Upgrading & Modernisation Programme (JUMP) and Jordan Services Modernisation Programme (JSMP) to support industrial and services companies to enable them to overcome the challenges arising from the global financial crisis, and consequently boost their competitiveness and ability to penetrate new markets.

7.1 *Jordan Upgrading & Modernisation Programme (JUMP)*

JUMP is managed by a steering committee headed by H.E. Minister of Industry and Trade and is equally comprised of representatives from both the public and private sectors. The programme is managed by experienced national staff assisted by the best local and international expertise. This programme works to transform, integrate and bridge the Jordanian industry within the global economy. Moreover, this programme is looking forward to improve and sustain the competitiveness of Jordanian enterprises by enhancing their managerial capabilities and productive capacities.

Consequently, a total number of 636 companies have received this support to date.

By which the programme objectives are:

- Enhance productivity, improve product's quality, and reduce unit cost;
- Benchmark and adopt best international business practices;
- Develop strategic direction driven by market needs;
- Enhance capabilities of human resources;
- Substitute imported production inputs by local products.

7.2 Jordan Services Modernisation Programme (JSMP)

The Jordan Services Modernisation Programme (JSMP) is an EU funded programme focusing on the development and modernisation of the Services sector. Its duration is 3 years (2009-2011) with a total budget of €16 million. Beneficiaries of the programme are private service sector enterprises - Small and Medium size Enterprises (SMEs) - relevant business associations and public sector bodies.

The main objective of JSMP is to assist Jordan to fully benefit from the opportunities of trade liberalisation of services in the context of the General Agreement on Trade and Services (GATS) and the economic integration objectives of the Istanbul Protocol signed in July 2004.

A total of 43 service companies and organisations benefited last year from the Jordan Service Modernisation Programme (JSMP), according to Jordan Enterprise Development Corporation (JEDCO).

The JSMP initiative, which seeks to increase exports of service companies, enabled beneficiaries to overcome the impact of the global downturn through its grants.

The JSMP will support companies in the services sector through participating in trade fairs, upgrading their exports capabilities, supporting societies and organisations, assistance in obtaining quality certificates and providing support for newly established service companies.

The importance of the Programme emanates from the fact that the services sector represents around 62 % of the gross domestic product and that the local added value in this sector is the highest among other sectors which is between 50 % and 60 %.

LITHUANIA

1. New functions of the Competition Council

After Lithuania's accession to the EU the Competition Council faced the task to adapt its activities to the essentially new environment in the area of state aid monitoring. The material changes in the aforementioned area introduced certain basic changes in the functions performed by the Competition Council in this respect. Upon the accession amendments to the Law on Competition providing for the new functions of the Competition Council in State aid area became effective. The amendments to the Law establish the role of the Competition Council as a coordinating authority in the field of State aid. Acting in accordance with the European Commission legal acts governing State aid and exercising its functions set forth in the Article 48 of the Law on Competition the Competition Council has been maintaining its closest relations with the European Commission and public authorities of the Republic of Lithuania for the purpose of discussion State aid issues, submitting its comments and proposals to the draft regulations of the European Commission, preparing responses to a number of questionnaires submitted by the European Commission. To make the measures provided for in the State aid action plan on the application of more efficient and simplified procedures operational it is of utmost importance to ensure an enhanced liability of Member States for the proper application of legal provisions. An event of profound importance in this respect was the adoption of the Commission Regulation (EC) No 800/2008 declaring certain categories of aid compatible with the common market in application of Articles 87 and 88 of the Treaty. The enactment of this Regulation as well as other legal acts governing State aid markedly enhanced the role of the Competition Council as authority coordinating the provision of State aid.

In accordance with the amended national Law on Competition the Competition Council performs the following functions:

- Participates in the submission of the notifications and annual reports (other information) on State aid to the European Commission,
- Provides consultations concerning the application of the State aid acquis to the State aid providers,
- Accumulates information on State aid provided in Lithuania (including the de minimis aid),
- Performs the education and public awareness, as well as other coordination activities, i.e., acts as a moderator between the European Commission and Lithuania, participates in the activities of the Advisory Committee on State Aid established by the European Commission, etc.

1.1 Participation in the submission of information to the European Commission

A very important area of activity of the Competition Council is the submission of notifications on State aid and the annual State aid reports to the European Commission. The procedure for the submission of the notifications has been defined by the Resolution of the Government of the Republic of Lithuania of 2004. The Resolution of the Government stipulates that State aid providers are obligated, in advance, to notify the Competition Council of all State aid proposals subject to the requirement to be notified to the

European Commission as defined by the EU regulations. Prior to passing the decision to grant State aid subject to block exemption provisions State aid providers also submit the information to the Competition Council on such State aid. The State aid providers submit such information by completing the notification forms established by relevant EU regulations.

Furthermore, the above Resolution of the Government stipulates that State aid providers shall submit to the Competition Council annual reports on the provided State aid by schemes of State aid approved by the European Commission (i.e., - annual reports on existing State aid). The annual reports on provided State aid under block exemption regulations have to be submitted to the Competition Council not later than one month preceding the expiry of the time limit for the submission of annual reports to the European Commission.

The Competition Council forward all the received information to the European Commission. As defined in the Resolution of the Government, upon receipt of the notification on State aid the Competition Council examine whether the notification has been properly completed, i.e., whether the submitted notification forms and annexes thereto are complete and all the supporting documents have been attached. The correctly completed notification the Competition Council by electronic form submit to the European Commission. In the event the notification has not been adequately completed the Competition Council notify the State aid provider thereof with an instruction to correct (supplement) the State aid notification, and indicating in writing the faults of the State aid notification.

1.2 Provision of consultations

Another important area of activity of the Competition Council after Lithuania's accession to the EU is the provision of consultations on issues related to State aid. The authority provides consultations and advice to State aid providers on all issues related to completing the State aid notification forms. The Competition Council analyses State aid projects submitted by State aid providers and assess the compliance of such projects with the requirements of the relevant EU legislation, draws up appropriate conclusions concerning such notifications and provides proposals. As set forth in the relevant Resolution of the Government concerning the submission of the notification to the European Commission, upon the request of State aid providers, prior to forwarding the notification to the European Commission the Competition Council shall perform the expert examination of the notification and furnish to the State aid providers its conclusions and recommendations concerning the compliance of the intended State aid to the requirements of the relevant EU regulations. The expert examination of the intended State aid notified to the Competition Council may also be performed in cases where no such requests have been filed by the State aid provider; however, the Competition Council has sufficient grounds to question the compatibility of the intended State aid with the requirements of the relevant EU regulations. It should be noted that in such cases, provided no objections are raised by the State aid provider, the State aid notification shall be forwarded to the European Commission only following such expert examination of the notification. State aid providers are entitled, at any stage of the expert examination of the notification performed by the Competition Council, request the Competition Council to submit the notification to the European Commission. In such event the expert examination of the notification shall be suspended and the notification shall be forwarded to the European Commission in an established order. In this case the State aid provider shall apply to the Competition Council with a request to suspend the expert examination of the State aid project and request that the notification be forwarded to the European Commission. As stipulated in the relevant Resolution of the Government the time limit for the submission of conclusions and recommendations concerning the compliance of the State aid to the EU requirements shall not be longer than 2 months from the date of the submission of the request of the State aid provider to the Competition Council to perform the expert examination of the State aid project, or the beginning of such examination in cases where the expert examination is performed without having received the respective request from the State aid provider. Such ex ante assessment of the intended State aid by the Competition Council is

expected to help avoid difficulties and problems arising in relation to the provision of aid in contravention of the relevant EU requirements. The properly developed national programs and experts adequately trained to implement such programs constitute an extremely important precondition for the successful absorption of resources made available by the European Union Structural and Cohesion Funds.

Alongside it must be noted that in accordance with the provisions of the European Community law only the EU institutions (the European Commission included) are authorised to assess the compatibility of State aid with the Common market. Therefore the conclusions drawn up by the Competition Council concerning the compatibility of the State aid projects may only be of advisory nature.

1.3 Accumulation of information on State aid

All information on State aid provided in Lithuania is accumulated in the State aid Register. The Central State aid Register was established in the year 2005. The Register includes not only the data on State aid meeting the criteria set forth in Art. 87(1) of the Treaty, but also the data on *de minimis* aid.

1.4 Representation of the Lithuania's position

Another important area of the activity of the Competition Council is the representation of the position of Lithuania in relation to State aid issues, i.e.:

- Representation of the position of Lithuania in dealing with various issues related to State aid (in particular issues defined in Regulation (EC) No. 659/1999);
- Representation of Lithuania in the Advisory Committee on State Aid set up within the European Commission in accordance with the above regulation;
- Participation in the meetings convened by the European Commission considering the State aid issues.

1.5 Activity aimed at enhancing the public awareness

Activity aiming at enhancing public awareness on State aid issues has always been and will remain an extremely important area of activity and the function of the Competition Council. All measures has to be taken to educate State aid providers and business community on issues related to State aid and the measures envisaged by the European Commission within the framework of the new State aid policy.

2. Volumes of state aid

According to the data available to the CC, the value of State aid granted in Lithuania during 2007 amounted to LTL 612.17m (EUR 177.3 m). The rate of the national State aid in relation to the GDP (at current prices) in 2007 accounted for 0.63 percent, in 2006 – 0.54 percent. For comparison: the EU-25 average in 2006 was 0.6 percent, in 2007 – 0.5 percent, the EU-15 average in 2006 and 2007 – 0.5 percent, and that of 12 new EU Member States in 2006 and 2007 – 0.8 percent. The average national State aid per working person in 2007 was LTL 399.01 (EUR 115.56), in 2006 – LTL 295.21 (EUR 85.57). The tables and graphs presented in the “Statistics” section show that in 2007, the volume of granted State aid was significantly higher than in 2006 (EUR 128.27 m), and in 2005 (EUR 119.16 m). According to the data available to the CC, the volumes of aid to agriculture increased by LTL 167.77 m (EUR 48.58 m). The increase is accounted for the support of LTL 127.05 m to entities engaged in agricultural activities who have sustained damage due to the fact that their agricultural plans had perished or suffered because of severe meteorological phenomena in 2006. State aid to industry and services in 2007 was only marginally

larger than in 2006, accounting to LTL 186.13 m (EUR 53.91 m), in 2006 – LTL 184.85 m (EUR 53.54 m). In 2007, as compared to the period 2004-2006, higher volumes of the State aid were allocated to environmental protection, implementation of the employment programmes, professional development. This readjustment of State aid structure comes in compliance with the objectives defined by the European Council to provide less but more targeted State aid, with higher volumes of aid resources channelled to horizontal general purpose objectives, i.e. regional development, small and medium-sized enterprises, research, development and innovations, and the implementation of employment programmes. Notably, the volumes of State aid as presented here do not include the funds received from the EU structural funds. The breakdown data of State aid:

Table 1: Total national state aid in Lithuania in 2007¹

Aid forms Sector	A1	A2	B1	C1	C2	D1	Total (LTLm)	Total (MEUR)
1.1. Agriculture	249.57	173.64	0.27				423.48	122.65
1.2. Fisheries	2.56						2.56	0.74
2. Industry/services	91.72	94.41					186.13	53.91
2.1. Horizontal aid	77.75	63.74					141.49	40.98
2.1.1. Research, development and innovations								
2.1.2. Environmental protection	6.60	56.44					63.04	18.26
2.1.3. SMEs	8.59						8.59	2.49
2.1.4. Trade								
2.1.5. Energy efficiency								
2.1.6. Investments								
2.1.7. Employment programs	13.90						13.90	4.03
2.1.8. Professional development	48.66						48.66	14.09
2.1.9. Privatisation								
2.1.10. Rescue/restructuring		7.30					7.30	2.11
2.2. Sectoral aid		11.95					11.95	3.46
2.2.1. Steel industry								
2.2.2. Ship-building								
2.2.3. Transport		11.95					11.95	3.46
2.2.4. Coal industry								
2.2.5. Synthetic fibre								
2.2.6. Other sectors								
2.3. Regional aid	13.97	18.72					32.69	9.47
Total	343.85	268.05	0.27				612.17	177.30
Manufacturing and services	91.72	82.46					174.18	50.45

Explanations of symbolic markings:

A1 – not recovered aid: grants, subsidies

A2 – tax exemptions, tax relief, write-off of late interest and penalties, other exemptions

B1 – different types of increase of the state-owned equity of enterprise or increase of its value

C1 – soft loans

C2 – tax deferrals

D1 – State guarantees

¹ Compensations for the provision of the services of general economic interest are not included.

Table 2: Total national state aid in Lithuania in 2000-2007 (MEUR)

Year Indicators	2000	2001	2002	2003	2004	2005	2006	2007
Total national State aid	68.70	39.73	74.96	40.67	120.38	119.16	128.27	177.30
Of which:								
- manufacturing and services	42.07	17.26	44.03	25.56	25.34	25.66	53.54	50.45
- agriculture and fishery	0.43	0.82	1.43	0.74	89.63	93.50	74.73	123.39
- transport	26.20	21.65	29.50	14.37	5.41	-	-	3.46

Table 3: Total national state aid in Lithuania in 2000-2007

Year Indicators	2000	2001	2002	2003	2004	2005	2006	2007
MEUR	68.70	39.73	74.96	40.67	120.38	119.16	128.27	177.30
EUR per employee	43.32	26.11	53.31	28.28	83.81	80.85	85.57	115.56
% of GDP (at current prices)	0.57	0.29	0.51	0.25	0.66	0.58	0.53	0.62
% of national budget expenditures	2.81	1.36	2.22	1.12	2.85	2.41	2.46	2.91
% of national budget deficit	66.50	13.21	23.50	12.42	55.73	71.77	119.27	50.60
Average population (m)	3.50	3.48	3.47	3.45	3.43	3.41	3.39	3.37

Table 4: Methods of granted national state aid in 2000-2007

	A1	A2	B1	C1	C2	D1	Total (LTL m)	Total (MEUR)
State aid 2000	225.55	7.45	0.06	0.01	0.07	22.48	255.62	68.70
State aid 2001	87.99	24.50	0.00	0.07	27.54	0.00	140.10	39.73
State aid 2002	93.09	127.19			38.45	0.07	258.8	74.96
State aid 2003	50.03	46.22	11.62	0.34	32.13	0.00	140.34	40.67
State aid 2004	202.79	183.33	13.40	0.03	15.69	0.40	415.64	120.38
State aid 2005	205.30	205.80	0.35				411.45	119.16
State aid 2006	243.88	198.86	0.12				442.86	128.27
State aid 2007	343.85	268.05	0.27				612.17	177.30

Explanations of symbolic markings:

A1 – not recovered aid: grants, subsidies

A2 – tax exemptions, tax relief, write-off of late interest and penalties, other exemptions

B1 – different types of increase of the state-owned equity of enterprise or increase of its value

C1 – soft loans

C2 – tax deferrals

D1 – state guarantees

Table 5: State aid assessed by resolutions of the European Commission in 2008

State aid notification registration in the EC	Title of the aid	Beneficiary sector	Purpose of the aid	Duration of the aid scheme	Decision of the Commission	Decision date
28-07-2007	No. 497/2007 Creation of broadband data transfer network in Lazdijai and Alytus municipalities	Telecommunications	Creation of broadband communications infrastructure		Approved	16-07-2008
19-10-2007	No. 666/2007 Aid for reimbursement of insurance premiums	Agriculture	To promote voluntary insurance from the damage caused by diseases of animals and plants, natural disasters and unfavourable weather conditions	Until 31-12-2013	Approved	13-02-2008
14-11-2007	No. 737/2007 Aid for reimbursement of guarantee payments	Agriculture	To reimburse the guarantee payment in respect of loans from credit institutions	Until 31-12-2013	Approved	13-02-2008
11-21-2007	No. 682/2007 Partial compensation for costs of insurance undertakings resulting from the payment of insurance payments for losses caused by drought	Agriculture	Partial compensation for costs of insurance undertakings resulting from the payment of insurance payments for losses caused by drought	Until 31-12-2013	Approved	03-06-2008
21-11-2007	No. 683/2007 Compensation of losses caused by transmittable animal diseases	Agriculture	Compensate losses for animal breeders in relation to the liquidation of the outbreaks of transmittable animal diseases	Until 31-12-2013	Approved	22-07-2008
17-12-2007	No. 755/ 2007 Aid for reimbursement of credit interest (except the purchase of land)	Agriculture	To reimburse the credit interest paid for the credits from credit institutions to implement investment projects	Until 31-12-2013	Approved	30-04-2008
19-12-2007	No. 764/2007 Aid to the Lithuanian Power Station	Energy	Construction of a 400MW Combined Cycle Gas Turbine		Not State aid within the meaning of Art. 87(1) of the EC Treaty	13-02-2008
15-04-2008	No. 197/2008 Regional aid for energy sector	Energy	Regional development	Until 31-12-2013	Approved	06-17-2008
19-11-2008	No. 587/2008 Aid for reimbursement of credit interest (except the purchase of land)	Agriculture	To reimburse the credit interest paid for the credit from credit institutions to implement investment projects	Until 31-12-2013	Approved	12-17-2008

MONGOLIA

Our country, Mongolia, has been implementing state intervention by providing aids and subsidies as other countries have, and these activities have been contributing to the economic and social aspects of our country. In regard to state aids and subsidies in 2008 and 2009, the largest proportions of state aids and subsidies were given to social, agriculture and education sectors. For instance, in 2008, 76% of total state aids and subsidies, namely about 273 billion tugrug were distributed to the social sector while 6%, approximately 17 billion tugrug, was provided to the agriculture sector. In 2009, 61% of total state aids and subsidies, namely about 167.25 billion tugrug, were distributed to social sector while 16%, approximately 43.6 billion tugrug, was provided to the agriculture sector. Please see the detailed information in Figure 1 and 2.

**Figure 1. State Aid and Subsidies by Sector
2008**

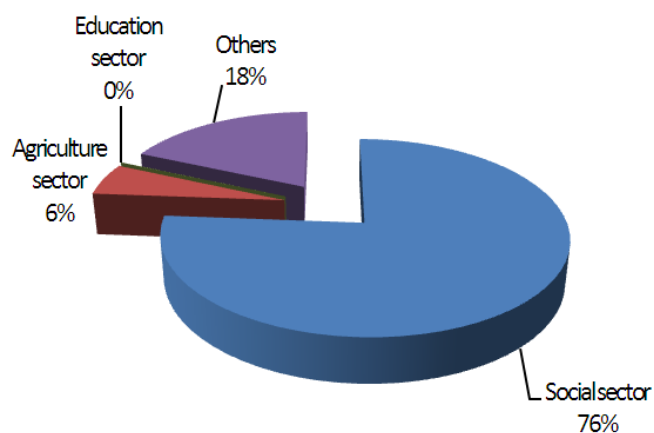

**Figure 2. State Aid and Subsidies by Sector
2009**

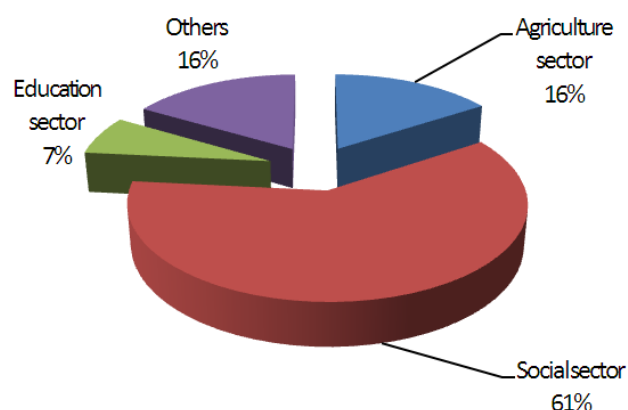

Remark: The amount of tax break and reduction is not included in the above mentioned state aids and subsidies.

The largest portion of the above mentioned state aids and subsidies consisted of aids, subsidies and interest rate reductions for overcoming the financial crisis and promoting small and medium sized enterprises. Moreover, as seen from the statistics, a large portion of state aids and subsidies was distributed into the agriculture sector.

1. The agricultural sector

In our country, as results of the successful implementation of “Campaigns for reclaiming the virgin lands under cultivation-1, 2” in 1959 and 1976, the independent husbandry sector was built and expanded. The area for cultivation reached 1.2 million hectares and the amount of production increased. It brought a range of important and valuable benefits, not only in public welfare, but also in the overall development of our country.

However, due to various reasons such as climate change in the world, the deterioration of the financial situation and also decrease in qualified, experienced specialists, just 30% of the area is harvested, only 24.9% of seeds are being harvested, 47.0% of vegetables and 86.0 percent of potatoes are harvested in the whole country.

Therefore, since 2008, “The 3rd Campaign for Reclaiming Virgin Lands” has been organised under Government resolution. In the framework of this campaign the Government is providing state aids and subsidies in this sector to a considerable degree. Particularly, in 2008 in order to support the floating capital for the business entities and individuals, Government provided a trust loan (a loan without a required deposit) in the amount of 1.0-2.0 billion tugrugs to some provinces. In addition, 10.2 billion tugrugs were distributed to the 103 projects which had applied for 30.2 billion tugrug to be involved in the credit on easy term from state.

Government imported 6.0 tons of seeds from outside by 6.4 billion tugrugs for the spring harvest and lowered the prices by 50 percent which costs 470 thousand tugrugs. Government has also sold the domestic seeds at 400 thousand tugrugs and granted 10758 ton seeds to the 300 entities and individuals at 20% prepayment for harvest.

In the scope of this campaign, Government invested petroleum to the 1044 entities and individuals. It cost 3.7 billion tugrugs to support them, and as result of this, 256.4 thousand hectares were harvested in 2009.

In 2008, when the National program of agriculture development ‘Campaign for Reclaiming Virgin Lands’ was launched, a total amount of 205.8 thousand tons of seeds, 142.1 thousand ton of potatoes, 80.6 thousand tons of vegetables and 15.7 thousand ton of hay were harvested in Mongolia.

Compared with same period of the 2007, the volume of seeds increased by 91.2 thousand tons, potatoes by 28.5 thousand tons and vegetable by 1.5 thousand tons. This satisfied 50% of the annual need seeds, 100% of the annual need of potatoes as well as 49% of the annual need of vegetables from domestic harvest.

In the scope of the ‘Campaign for Reclaiming Virgin Lands’ 32.7 billion tugrugs were spent in 2008.

In order to enhance the fruit production in Mongolia, 835 million tugrugs were lent to the selected projects of 30 entities and 13 individuals from 18 provinces.

In 2009, 30 billion tugrugs were allocated in budget amendment to provinces for promoting small and medium sized enterprises, 850 million tugrugs were also placed in funding for the development of small and medium sized enterprises.

2. The petroleum product sector

Our country provides for the consumption of petroleum products totally by import and 90% of it has been providing by only a Russian company named “Rus-neft”. In other words, that company is a monopoly supplier for Mongolia. Increasing the petroleum product price year-by-year and month-by-month has had adverse effects on the normal activities of enterprises (importers) and also to the cost of living. Therefore, the Government of Mongolia has decided to provide custom tax and excise duty reductions for petroleum product importers in order to prevent price increase. This could be a good decision for preventing excessive price increase and stabilisation. This provides fair chances to private and state-owned companies, and international and domestic companies could not restrict competition and raised any unfair competition.

3. The construction sector, by the plan of 2010

In our construction sector, financial difficulties have been raised and some companies face the problem that they cannot pay the interest rate for banks. This would lead to difficulties for the construction sector and commercial banks. So, our government is planning to provide apartment mortgage loans for

civil servants in a way of selling Government bonds of 180 billion tugrugs in order to solve financial difficulties in construction sector and to improve the liquidity of commercial banks.

In the competition law of Mongolia, which is called “The law on prohibiting unfair competition”, there are no specific regulations on state aids and subsidies. However, in chapter 11 of this law, there is a group of regulations which are focused on prohibiting the decision of state authorities on restricting competition. In the scope of this group of regulations, it is possible to prohibit distributing state aids and subsidies unfairly and restricting competition.

Nowadays, we, the Authority for Fair Competition and Consumer Protection, have no cases which are about state aids and subsidies leading to restricted competition.

We will focus on controlling on state aids and subsidies in view of competition.

COMPETITION COUNCIL OF MOROCCO

1. Introduction

Competition, a fundamental pillar of the market economy, has been the cornerstone of the capitalist system and one of the determining factors in trade relations for modern world economies ever since the industrial revolution first took root.

Yet, one should point out that the supporters of the capitalist system are divided between the proponents of orthodox liberalism, who consider the market to be self-regulating and the interventionists, who hold that the capitalist system - and therefore the market and competition – has to be regulated on an on-going basis if growth, prosperity and social progress are to be ensured.

Moreover, since the end of the 19th century, the two schools of thought have succeeded each other in public management and, as far as some elements of each are concerned, even exist alongside each other. In fact, compliance with competition regulations by controlling such well-known practices as cartels, the abuse of dominant position and concentrations does not always explicitly cover state aid. The latter seems to be more the province of industrial policy. To put it another way, the competition balance and the economic balance do not always add up.

The issue then is as follows: competition, based on the idea of merit and the continuous process of creative destruction, encourages firms to be innovative and efficient.

With regard to state aids, although in some ways they are of no harm to competition, in others they can distort competition and generate distorted rents thereby decreasing the economic surplus since it can divert production and investment towards the least efficient units.

Apparently, then, state aid, in some ways, should be the fourth component of anti-competitive practices. However, it is not always treated as such, because it is supposed to serve a different purpose. The problem is, then, that aid can sometimes be justified; firstly, when it comes to investments which do not hinder competition and which are of benefit to all involved - such as infrastructural spending. Aid can also be justified when it comes to exemption from competition regulations, either on the grounds of social cohesion or on economic grounds relating to support for innovation, aid for start-up industries, regional development, or even for the purpose of strengthening the operation of the market itself and, hence, the competitive process in the developing countries.

In short, for many thinkers and players on the ground, competition and state aid, despite their apparent contradictions, are policies that somehow have to be reconciled. Moreover, the experience of the developing countries shows that some degree of priority has often been given to industrial policy and state aid.

Given the foregoing, and acknowledging that state aid policy may not always be in line with competition policy, in what domains can it be useful without making a travesty of the culture of market economy and competition that economic efficiency so sorely needs?

Taking Morocco and its experience in this area since its independence in 1956, as a case in point, there are three phases that are very relevant to this issue:

- The phase when state aid took precedence over competition (1956-1982);
- The phase of structural adjustment of the Moroccan economy, accompanied by liberalisation with the market economy and competition to the fore (1983-1998);
- Lastly, the phase of seeking a balance between an outline competition policy, considered as the cornerstone of the system, and state aid to support the imperatives of an emerging economy.

Let us try to look first of all at the first two of these stages, which could be qualified broadly as a period of extremes in state aid and competition that prevailed until the end of the nineties, before going on to look at the current decade, which is committed to seeking some sort of balance between competition policy and state aid.

2. The phase of extremes: from seeking accelerated development through state aid to structural adjustment with competition taking precedence

We will successively review state aid policy which prevailed in the first 25 years following independence, then the period of liberalisation, starting with the structural adjustment policy in 1983 and lasting until the end of the 1990s.

2.1 *Predominance of state aids from 1956 to 1982*

When we look at the development of economic policy in Morocco over the quarter-of-a-century since independence, it has to be said that despite the fact that it had always opted for a market economy, unlike most third-world countries of the period, the size of its public sector economy in the widest sense of the term - with all its administrative, quasi-administrative and entrepreneurial machinery and state aid granted to both public and private sector enterprise - remained disproportionate, accounting as it did for 65 to 70 per cent of the size of the country's economy.

Turning specifically to state aid, this was delivered chiefly within the framework of a number of investment codes, the most important of which were the agricultural investment code and the tourism and industry investment codes. These codes were intended partly to encourage the private sector to take the place of intervention by the state, which remained the biggest economic player of the period, partly to promote more balanced regional development. Public resources allocated to economic development saw a very sharp increase (of about 800 per cent), rising from MAD 2.2 billion just after independence (approximately USD 300 million in today's terms) to MAD 17.9 billion (approximately USD 2.3 billion) in 1980.

In addition to this state aid, state intervention - other than in the social sector, which received moderate support - came in the form of fiscal incentives to the private sector up to and including total exemption from tax for agriculture.

Unfortunately, this interventionism was not matched by any degree of efficiency in public management. The outcome was conclusive neither on the social or the economic level.

As for the human development dimension, the fact of the matter is that Morocco had reached an extremely difficult situation whether in terms of standard of living, the inadequacy of its education system, the persistence of high illiteracy or the difficulties in accessing health and housing services. On an economic level, the results were also inconsistent and disappointing since, despite all of the government's interventions, the average rate of growth from 1972 to 1982 was no higher than 4.9 per cent (6.7 per cent from 1973 to 1977; 3.2 per cent from 1978 to 1982) while the average rate of inflation hovered around 9.5 per cent. The public account deficit hit around 12 per cent in 1982. Lastly, the external deficit (running at an average 12.3 per cent) was so high that import invoices could no longer be honoured on time.

Towards the end of the 1980s, Morocco was on the verge of defaulting on payments. This situation would justify the intervention of the IMF and endorse its injunctions through the implementation of a neo-liberal-based structural adjustment policy as of 1983. Moreover, this change in Morocco's circumstances coincided with the new wave of liberalism that was sweeping over every continent at the time.

2.2 *Structural adjustment policy: 1983-1998*

Morocco had very definitely set out on a new course, directed towards a more liberal policy. Economic efficiency was now being sought through competition rather than through state aid, although the public resources allocated to investment continued to increase (MAD 70.38 billion in 1990 as opposed to MAD 17.32 billion in 1978). This policy, based on fiscal restraint and structural reform, primarily through privatisation, produced a marked improvement in Morocco's macro-economic equilibrium. The budget deficit during the 1990s was seldom higher than 3 percent of GDP; the same was true for the rate of inflation. As for the external balance, although the trade deficit was persistent, it was more than offset by tourism revenues, transfers from Moroccan residents abroad and foreign investment. It is notable that from that point on, overseas reserves could cover six months of exports. The average growth rate was around 3 per cent.

At the sight of these results, we can be pleased in some regards, primarily with the macro-economic equilibrium; however, there are two major problems that must be highlighted. The first of these is the mass impoverishment of Moroccans. The explanation is that while adjustment and reform of the public finances enabled us to re-establish the macro-economic equilibrium, they inevitably exacerbated inequalities and increased poverty. The second point is that the average rate of growth, albeit positive, has remained relatively low as a result of the reduction in public finances and the impact of erratic weather patterns. In any case, this rate of growth does nothing to help make up lags or allow for the pressures of demographic growth, although the latter has declined somewhat.

These results, somewhat mixed when all is said and done, are not due simply to the structural adjustment policy and the choice of liberalisation. The fact is that, although the size of the state in the economy shrank slightly, the economy as a whole was still hampered by the problems of an administration that was unable to keep pace with follow-up and support for the new liberal strategy, by a justice system that was not up to the development of business or activities and by a climate of rampant corruption. This situation would lead, from the end of the 1990s, to a new approach to the problem of competition and state aid. It must be added that this period experienced a calm change of politics with regards to the country's political situation, and in particular a change of ruling with King Mohamed VI coming to power.

3. *The dawn of the third millennium and the balance between competition policy and state aid policy*

The 2000s would see a significant improvement on some sticking points. The liberal road map is now in place; privatisations are proceeding under better conditions, comparatively speaking; political governance looks to be relatively calm; the administration seems to be working somewhat better; which means that state efforts in terms of investment are now more evident in some areas, particularly infrastructure.

Morocco seems, perhaps, to be steering a course which, while wishing to make more room for competition policy, is trying to use state aid as leverage to promote the emergence of the market economy and cope with some of the pressures arising from the social situation and the development goal in general. Let us state that aid, subsidies, fiscal and other incentives still account for a major share of GDP. At the end of 2007, they amounted to around USD 8 billion (of which 45 per cent fiscal expenditure) or approximately 12 per cent of GDP.

However, let us again state that the goal of competition is the backbone of the new road map; as a result, there is a tendency to be clearer about the considerations on which the new State aid policy is based. There are five main challenges that can be identified:

- Supporting the various sectoral development plans implemented by the government, such as the « *Plan Azur* » for tourism, the *Plan emergence* for industry, the *Plan verte* for agriculture and the *Plan bleu* for fisheries;
- Modernising a certain number of firms in order to engage them in the competitive approach and ensure that a genuine market emerges;
- Developing foreign investment and underpinning our external balance by encouraging exports and foreign investment as well as tourism and revenue transfers by Moroccans residing abroad;
- Helping job-generating firms that find themselves in difficulty;
- Helping the social strata that are unable to bear real-cost pricing as a result of the operation of the market.

Overall, analysing the situation from the standpoint of the Moroccan economy, which I've had occasion to observe more closely, one can identify potential pockets of State aid on a social level as well as in the domestic economy and international relations.

3.1 *The social dimension of state aid*

State aids take two major forms. They reside primarily in social investment expenditure, which in no way hinders competition, but rather creates the conditions for a genuine market economy. It may well include investment allowing rural areas and peripheral cities access to electricity and drinking water. We can also say that awareness of social issues and poverty has never been so delicate. The latter form of state aid is in effect an exemption from competition rules - an exemption due to certain peculiarities of Moroccan society. The main difference is that even with a fully operational market, the best resulting price may be higher than the level of income of certain strata of the population. It then becomes necessary to subsidise certain consumer staples. That is what Morocco does through its « Caisse de Compensation ».

Aid provided by this means amounted to around MAD 30 billion in 2008 and the forecast for 2009 puts it in the region of MAD 14 billion, chiefly as a result of the fall in energy prices. We are currently in the process of debating this issue: Should we continue to subsidise products that benefit all, or institute free-market pricing and grant state aid in the form of direct revenue distributed to the economically vulnerable?

Needless to say that in addition to this type of structural support, Morocco's experience shows that action in the form of cyclical support may sometimes be needed as a result of global developments in the price of certain consumer staples or of the fluctuating agricultural cycle in Morocco or following the last global crisis.

3.2 *The economic dimension of state aid*

On the economic level, too, there are state aids that do not inhibit competition and a number of exemptions of a structural nature to the principle of competition.

Regarding the first form of intervention, it regards fundamentally expenditure on infrastructure and economic reorganisation affecting both administration, education, the legal system and the upgrading of sectors of economic activity through the "Emergence" - "Azur" - "Green" and "Blue" plans... It also concerns the actions which constitute exemptions from competition policy. It may well include subsidies that affect agriculture, other priority sectoral plans, the informal sector, national champions and SMEs.

Turning first to agriculture, it has to be said that Moroccan agriculture, which covers 9 million hectares of land, of which 12 per cent are irrigated, suffers as much from the preponderance of small farms,

three-quarters of them under 5 hectares, as from the erratic climate. The problem lies in very poor efficiency and the fact that although agriculture only accounts for 15 per cent of Morocco's GDP, it employs more than 45 per cent of the population. It is easy to see why state aid is needed at times, although it flies in the face of all economic sense and the principle of competition. The aid provided includes both factors of production and the total tax exemption of the sector. A tentative solution to such a problem would entail far-reaching reforms based on land consolidation and the emergence of viable farms, which would be a socially difficult and politically very demanding task.

Let us add that the other sectoral plans (for industry, tourism and fisheries, etc.) also benefit, chiefly in terms of investment, from tax concessions and major state-owned inputs.

As for the informal sector, it plays a very large role in the Moroccan economy; according to the latest survey by the High Commission for Planning (*Haut Commissariat au Plan*), unregulated SMEs number around 1.55 million, increasing by around 350 000 units per year from 1999 to 2007. This sector is a major actor in trade (57.4 per cent), services (20 per cent), industry (20 per cent) and the construction industry (5.4 per cent). It reportedly employs some 2.2 million people and accounts for 14.3 per cent of GDP. The informal sector includes firms which evade taxes and social security regulations and firms which engage in contraband activities. The problem, apart from the fact that certain practices are not within the remit of the competition authorities, is the trade-off between employment and fair competition. What should one do in a case like this? The question as yet remains unanswered.

Furthermore, similar problems arise even with legitimate SMEs; the latter play a key part in fostering employment and spreading innovation. Their development sometimes requires incentives, whether in the form of state aid or tolerance of certain anti-competitive practices, such as certain levels or types of cartel agreement. How far should this type of practice be tolerated?

The same question also arises with national champions: some of them spur on the economy through research, innovation and competition.

This raises a number of questions: how does one aid research and competitiveness yet make the right trade-off between the latter and barrier-free competition? How does one avoid the slippery slope towards preferential treatment for influential members of economic organisations under the guise of aid for innovation and exports?

Lastly, alongside these structural situations, circumstances arising from the economic cycle – as was the case with the latest crisis – may justify regulations that curb or restrain competition principles. This was why a comprehensive aid plan for the textile sector was implemented in Morocco. The question in this case is the following: how is one to ensure that the crisis is not used as a pretext to return to permanent protectionist practices?

3.3 Competition, regulation and international economic relations

Let us point out that since the WTO agreements, we have been witnessing an unprecedented liberalisation of trade. Liberalisation has been reinforced by numerous multilateral and bilateral agreements. The problem that this poses touches on a number of issues that are causing significant difficulties for international trade relations and North-South relations. The three main such issues are: agricultural subsidies, exports and social dumping and the positioning of cartels and certain major multinationals.

First, agricultural subsidies, which concern both Morocco and its partners: It should be noted that under "advanced status" arrangements, Morocco secured a grace period of 10 years to upgrade its agri-food and fatstock production since these activities essentially concern Morocco's large and poor peasant-farmer population. In contrast, modern agriculture as it is termed - basically citrus fruit and vegetable production - is efficient, but is more affected by Europe's common agricultural policy, which poses

problems - despite the fact that quotas were raised some time ago – with barriers to entry and the subsidy mechanisms for its own agriculture.

This is a major socially and politically sensitive issue for all countries. In actual fact, under the free-trade agreements signed with the North, these subsidies seem to handicap, first and foremost, certain countries of the South. It has to be said that while the subsidies that developing countries resort often have a social or survival component, the state aid provided for agriculture in the countries of the North makes competition just as hard for the production of the countries of the South. The main issue that arises with this aid are the limits of this transition period.

The second problem concerns the promotion of exports and social dumping; let us add that promoting exports in countries that do not yet have a culture of competitiveness sometimes requires a degree of support, chiefly incentive support. How far can one tolerate such practices?

As regards social dumping, more specifically, the practices concerned are low wages and non-compliance with social security requirements. Clearly, this causes unfair competition at the expense of certain countries. Nevertheless, let us be clear that while such practices exist in certain sectors, they cannot be lumped together with objective situations where low wages are a factor in competitive production. Otherwise, why not call into question the technological lead of the industrialised countries?

Moreover, in the case of Morocco, for instance, the guaranteed minimum wage level (SMIG) compared with the French SMIG is perhaps rather more to the advantage of French exports since the ratio is approximately 1:5 while the ratio for per capita GDP is about 1:9.

Lastly, one might mention the case of cartels and large multinational firms; this is a major transnational problem which works to the disadvantage of the countries of the South. Some cartels and large multinational enterprises make use of certain State aids and their subsidiaries to carve up the markets of developing countries between them, taking advantage of their well-known lack of competition regulation. What should one do, in this case? And at what level?

4. Conclusion

In conclusion, despite the objective difficulties arising from all of these issues, it can be said that Morocco's economic and social policy during the decade now coming to an end has been more prudent as regards seeking a balance between competition policy and state aid policy, growth policy, social welfare policy and the fight against poverty. It has preserved the fundamentals; the average growth rate is around 5.5 per cent; the budget deficit is being kept within acceptable limits; the trade deficit, with the exception of some difficulties arising from the latest crisis, is offset by tourist revenues and transfers from Moroccans abroad as well as by foreign investment. All of this is being achieved against a background of major inland and maritime construction projects as well as major industrial and tourism projects. It can also be noted that the number of social action projects is increasing. Is that to say that the choices being made are totally cohesive and that there are no large projects still to be implemented? It seems to me that among Morocco's technocrats there is still a prevailing culture that favours state aid, with all that entails such as efficiency difficulties, over competition policy; likewise, despite all the efforts made on an economic and social level, there are still serious problems with the trade balance deficit, the education system, administrative management, the justice system, the persistence of certain isolated areas of poverty, and escalating corruption, which - although it spares some circles at senior levels of the administration - seems to be affecting broad swathes of society.

Hence, we are at the end of a process of major managerial achievements taking account of both competition policy and state aid policy. The coming decade, along the same lines, will probably be the period that sees major structural reforms.

CONSEIL DE LA CONCURRENCE DU MAROC

1. Préambule

La concurrence, pilier fondamental de l'économie de marché, a toujours constitué, depuis l'émergence et l'affirmation de la révolution industrielle, l'ancrage du système capitaliste et l'une des composantes déterminantes des rapports d'échange des économies du monde moderne.

Précisons tout de même que parmi les partisans du système capitaliste, s'opposent les tenants du libéralisme orthodoxe qui considèrent que le marché s'autorégule spontanément et les interventionnistes qui pensent que le système capitaliste, et donc le marché et la concurrence, doivent être régulés de façon continue afin d'assurer croissance, prospérité et progrès social.

D'ailleurs, depuis la fin du 19^{ème} siècle, les deux écoles se sont succédées à la gestion des affaires publiques, voire même coexistent par certaines de leurs composantes. En effet, le respect des règles de la concurrence à travers le contrôle des pratiques bien connues que sont les ententes, les abus de position dominante et les concentrations ne couvre pas toujours de façon explicite les aides d'État. Celles-ci paraissent plutôt relever de la logique de la politique industrielle. Autrement dit, bilan concurrentiel et bilan économique ne fusionnent pas toujours.

La problématique est dès lors la suivante : la concurrence, de par l'idée du mérite et le processus permanent de destructions créatrices, stimule l'innovation et l'efficacité des entreprises.

Quant aux aides publiques, si de par certains aspects, elles peuvent ne pas gêner le jeu de la concurrence, elles peuvent également fausser le principe d'émulation et générer des distorsions rentières et de baisse du surplus économique dans la mesure où la production et l'investissement peuvent être détournées vers les unités les moins productives.

Apparemment donc, les aides d'État, de par certains aspects, devraient constituer la quatrième composante des pratiques anticoncurrentielles. Elles ne sont cependant pas toujours traitées en tant que telles parce que réputées relever d'une autre logique. Le problème réside ainsi dans le fait qu'elles peuvent parfois être justifiées ; elles peuvent l'être d'abord lorsqu'il s'agit d'investissements qui n'entravent pas le jeu de la concurrence et bénéficient à tous les acteurs comme les dépenses d'infrastructure. Elles le sont également lorsqu'il s'agit d'exemptions aux règles de la concurrence soit pour des considérations de cohésion sociale, soit pour des raisons économiques liées au soutien de l'innovation, à l'aide des industries naissantes, au développement régional, voire même à la volonté de renforcer le fonctionnement du marché et donc du processus concurrentiel dans les pays en développement.

Bref, pour beaucoup de penseurs et d'acteurs du terrain, concurrence et aides d'État sont, malgré leurs contradictions apparentes, des politiques dont la conciliation s'impose quelque part. Bien plus, l'expérience des pays en développement démontre qu'une certaine priorité a souvent été donnée à la politique industrielle et aux aides d'État.

Partant de là, tout en admettant que la politique des aides d'État peut ne pas être toujours en phase avec celle de la concurrence, dans quels domaines peut-elle être utile sans travestir l'esprit de l'économie de marché et de la concurrence, tant nécessaires pour l'efficacité économique ?

Si nous prenons le cas du Maroc et son expérience en la matière depuis son indépendance en 1956, on peut déceler trois phases importantes par rapport à cette problématique :

- La phase de la primauté des aides d'État au détriment de la concurrence (1956-1982) ;
- La phase d'ajustement structurel de l'économie marocaine via la libéralisation et la mise en évidence de l'économie de marché et de la concurrence (1983-1998) ;
- Enfin, la phase de recherche d'un équilibre entre l'esquisse d'une politique de la concurrence, considérée comme le fondement du système, et les aides d'État accompagnant les impératifs de l'émergence économique.

Essayons de nous pencher d'abord sur les deux premières phases qu'on peut qualifier globalement de période des extrêmes en matière d'aides d'État et de concurrence, période qui a prévalu jusqu'à la fin des années quatre-vingt-dix, avant de nous pencher sur la décennie actuelle qui consacre la recherche d'un certain équilibre entre politique de la concurrence et aides d'État.

2. La phase des extrêmes: de la recherche du développement accéléré par les aides d'État à l'ajustement structurel et la primauté de la concurrence

Examinons successivement la politique des aides d'État qui a prévalu durant le premier quart de siècle qui a succédé à l'indépendance avant de nous pencher sur la période de libéralisation qui a démarré avec la politique d'ajustement structurel en 1983 et duré jusqu'à la fin des années quatre-vingt-dix.

2.1 La prédominance des aides d'État durant la période allant de 1956 à 1982

Lorsqu'on se penche sur l'évolution de la politique économique du Maroc durant le quart de siècle qui a suivi l'indépendance, force est de constater que malgré le fait qu'il ait toujours opté pour l'économie de marché, contrairement à la majorité des pays du tiers monde de l'époque, le poids de l'économie publique au sens large du terme, avec ses composantes administrative, para-administrative et entrepreneuriale ainsi qu'avec les aides d'État accordées aussi bien aux entreprises publiques que privées, est resté prépondérant, représentant ainsi 65 à 70% du poids économique du pays.

Si nous nous attachons particulièrement aux aides d'État, elles se sont fondamentalement exprimées dans le cadre d'un certain nombre de codes des investissements dont les plus importants sont le code des investissements agricoles et ceux du tourisme et de l'industrie. Ces codes ont été conçus, d'une part dans la logique d'amener le secteur privé à relayer l'action de l'État qui restait le plus grand acteur économique de l'époque, d'autre part à promouvoir un développement régional plus équilibré. Les ressources publiques affectées ainsi au développement économique ont connu une très forte augmentation (environ 800%) passant ainsi d'environ 2,2 milliards de DH au lendemain de l'indépendance (approximativement 300 millions de \$ en valeur d'aujourd'hui) à 17,9 milliards de DH (environ 2,3 milliards de \$) en 1980.

En plus de ces aides d'État, l'activisme public s'est manifesté, outre le domaine social qui a été soutenu moyennement, par des incitations fiscales au secteur privé allant jusqu'à la défiscalisation totale de l'agriculture.

Malheureusement, ce volontarisme n'a pas été accompagné d'une certaine efficacité au niveau de la gestion des affaires publiques. Le résultat n'a pas été probant aussi bien sur le plan social que sur le plan économique.

Concernant la dimension du développement humain, force est de constater que le Maroc avait atteint des situations extrêmement difficiles aussi bien en termes de niveau de vie, qu'en ce qui concerne l'inefficience du système éducatif, la persistance du taux d'analphabétisme, les difficultés d'accès aux services de santé et au logement. Sur le plan économique, les résultats étaient aussi inconséquents et décevants puisque malgré tout l'activisme public, le taux de croissance moyen de 1972 à 1982 n'a pas dépassé 4,9% (6,7% entre 1973 et 1977 ; 3,2% entre 1978 et 1982) alors que le taux d'inflation moyen se situait autour de 9,5%. Quant au déficit du trésor public, il a atteint environ 12% en 1982. Enfin, le déficit extérieur (12,3% en moyenne) était tellement important qu'on n'arrivait plus à honorer à temps les factures d'importation.

Vers le début des années 80, le Maroc était alors pratiquement en cessation de paiement. Ce qui va justifier l'intervention du FMI et autoriser ses injonctions par la mise en œuvre, à compter de 1983, d'une politique d'ajustement structurel d'inspiration néolibérale. Cette nouvelle donne a d'ailleurs coïncidé avec le nouveau souffle libéral qui a essaimé sur tous les continents.

2.2 La politique d'ajustement structurelle: 1983-1998

Un nouveau cap, orienté vers une politique plus libérale, est décidément franchi. On recherche plus l'efficience économique par la concurrence que par les aides d'État même si les ressources publiques destinées à l'investissement ont continué à augmenter (70,38 milliards de DH en 1990 contre 17,32 milliard en 1978). Cette politique, fondée sur la rigueur budgétaire et la réforme structurelle, notamment par la privatisation, a permis un redressement certain au niveau des équilibres macro-économiques du Maroc. Le déficit budgétaire durant la décennie quatre-vingt-dix n'a que rarement dépassé les 3% du PIB ; il en est de même pour le taux d'inflation. Quant à la balance extérieure, si le déficit commercial est persistant, il est surcompensé par les recettes touristiques, les transferts des résidents marocains à l'étranger et par l'investissement étranger. Il est à noter que depuis cette époque, les réserves extérieures permettent de couvrir environ six mois d'exportation. Quant au taux moyen de croissance, il s'est situé autour de 3%.

Lorsqu'on observe ces résultats, on peut s'en réjouir par certains aspects, notamment par rapport aux équilibres macro-économiques ; et pourtant, deux problématiques majeures sont à mettre en évidence. On peut d'abord invoquer la paupérisation massive des marocains. C'est que la politique d'ajustement et d'assainissement relatif des finances publiques a permis de rétablir les équilibres macro-économiques, mais elle a inéluctablement approfondi les inégalités et développé la pauvreté. Le deuxième constat a trait au fait que le taux de croissance moyen, bien que positif, est resté relativement modeste du fait du recul des soutiens publics et de l'impact des aléas climatiques. En tout état de cause, ce taux de croissance ne permet nullement de rattraper les retards et de tenir compte de la pression de la croissance démographique, bien que cette dernière ait enregistré un certain recul.

Ces résultats, somme toute assez mitigés, ne sont pas dus uniquement à la politique d'ajustement structurel et au choix en faveur de la libéralisation. C'est que, si le poids économique de l'État a légèrement reculé, le monde économique souffrait toujours des problèmes d'une administration en retard de phase de suivi et d'accompagnement par rapport à la nouvelle logique libérale, d'une justice non adéquate au développement des activités et des affaires et d'un climat galopant de corruption. Cette situation allait déboucher à partir de la fin des années quatre-vingt-dix sur une nouvelle approche concernant la problématique de la concurrence et des aides d'État. Il faut préciser que cette période a connu une alternance politique apaisante pour le jeu politique dans le pays et surtout un changement de règne avec l'accession au Trône du Roi Mohamed VI.

3. L'aube du Troisième Millénaire et l'équilibre entre la politique de la concurrence et la politique des aides d'État

Les années deux mille vont connaître un redressement sérieux par rapport à un certain nombre de données bloquantes. La feuille de route libérale est toujours là ; les privatisations se font relativement dans de meilleures conditions ; la gouvernance politique est relativement apaisée ; l'Administration semble quelque peu mieux fonctionner ; ce qui fait que les efforts publics en matière d'investissement et d'aides sont plus palpables dans certains domaines, particulièrement au niveau des infrastructures.

On semble peut-être prendre une orientation qui, tout en voulant accorder une place plus grande à la politique de la concurrence, essaie de faire jouer le levier des aides publiques pour favoriser l'émergence de l'économie de marché et faire face à certaines contraintes ayant trait à la situation sociale et à l'objectif de développement d'une façon générale. Précisons que ces aides, subventions, incitations fiscales et autres, représentent encore une part importante du PIB. Elles ont atteint, à fin 2007, environ 8 milliards de \$ (dont 45% de dépenses fiscales), soit approximativement 12% du PIB.

Reprécisons cependant que l'objectif de concurrence constitue l'ossature de la nouvelle feuille de route ; de ce fait, on a tendance à mieux préciser les considérants à la base de la nouvelle politique d'aide d'État. On peut relever cinq défis essentiels :

- Accompagner les différents plans à développement sectoriel mis en œuvre par le gouvernement comme le plan Azur pour le tourisme, le plan émergence pour l'industrie, le plan vert pour l'agriculture et le plan bleu pour la pêche ;
- Mettre à niveau un certain nombre d'entreprises pour les amener à la logique concurrentielle et faire émerger un véritable marché ;
- Développer les investissements étrangers et renforcer notre balance extérieure par l'encouragement des exportations et des investissements étrangers ainsi que par l'encouragement du tourisme et des transferts de revenus des marocains à l'étranger ;
- Aider les entreprises en difficulté et génératrices d'emploi ;
- Aider les couches sociales qui ne peuvent pas supporter la vérité des prix résultant de fonctionnement du marché.

Globalement et à l'examen de la situation au niveau de l'économie marocaine que j'ai eu à mieux observer, on peut déceler des îlots d'aides d'État possibles aussi bien au niveau social, qu'au niveau économique interne et des relations internationales.

3.1 La dimension sociale des aides d'État

Les aides de l'État prennent deux formes importantes. Elles résident d'abord dans dépenses d'investissement social qui ne gênent en rien la concurrence, mais créent plutôt les conditions d'une véritable économie de marché. On peut ainsi citer les investissements permettant l'accès du monde rural et périphérique des villes à l'électricité et l'eau potable. On peut également dire que jamais la sensibilisation aux questions sociales et de la pauvreté n'ont été aussi sensibles. La dernière forme d'aide d'État constitue en fait une exemption par rapport aux règles de la concurrence ; exemption due à certaines particularités de la société marocaine. La principale spécificité concerne le fait que même lorsque le jeu concurrentiel fonctionne pleinement, le meilleur prix qui en découle peut se situer au-delà des niveaux de revenus de certaines couches de la population. S'impose alors la nécessité de subventionner certains produits de consommation de base. C'est ce que nous faisons au Maroc à travers la Caisse de Compensation.

Les aides accordées par ce biais ont atteint environ 30 milliards de DH en 2008 et les prévisions pour 2009 se situent autour de 14 milliards à cause du recul du prix de l'énergie, notamment. Nous vivons actuellement un débat sur la question : Faut-il continuer à subventionner des produits qui bénéficient à tout le monde, ou instaurer la liberté des prix et accorder des aides d'État sous forme de revenus directs, distribués aux économiquement faibles.

Précisons enfin qu'en plus de cette situation de type structurel, l'expérience marocaine démontre que des actions de soutien de type conjoncturel s'imposent parfois du fait de l'évolution conjoncturelle mondiale concernant les prix de certains produits de consommation de base ou en raison du cycle agricole versatile de l'agriculture marocaine ou suite enfin à la dernière crise mondiale.

3.2 La dimension économique des aides d'État

On retrouve également à ce niveau, les aides d'État qui n'entravent pas le jeu de la concurrence et un certain nombre d'exemptions au principe concurrentiel de type structurel.

Concernant la première forme d'intervention, il s'agit fondamentalement des dépenses d'infrastructure et de réorganisation économique touchant aussi bien l'administration, le système éducatif, la justice et la mise à niveau des secteurs d'activité économique à travers les plans « Emergence » - « Azur » - « Vert » et « Bleu »... Il s'agit également des actions qui constituent des exemptions à la politique de la concurrence. On peut ainsi citer les subventions qui concernent l'agriculture, les autres plans sectoriels prioritaires, le secteur informel, les champions nationaux et les PME.

Concernant d'abord l'agriculture, force est de constater que l'agriculture marocaine qui couvre 9 millions d'hectares dont 12% irrigués, souffre autant de la prépondérance des petites exploitations dont les trois quarts ont moins de 5 hectares que des conditions climatiques aléatoires. Le problème réside dans sa très faible efficacité et dans le fait que tout en ne procurant que 15% du PIB marocain, elle emploie plus de 45% de la population. On comprend aisément que des aides d'État s'imposent parfois à l'encontre de toute logique économique et concurrentielle. Ces aides concernent aussi bien les facteurs de production que la défiscalisation totale du secteur. L'esquisse d'une résolution d'une pareille problématique suppose une réforme profonde du foncier fondée sur le remembrement des terres et l'émergence d'exploitations viables, ce qui est difficile socialement et fort laborieux politiquement.

Précisons par ailleurs que les autres plans sectoriels (émergence, azur, bleu...) bénéficient également, notamment en ce qui concerne l'investissement, d'avantages fiscaux et de moyens de production importants appartenant à l'État.

Concernant le secteur informel, il occupe une place prépondérante dans l'économie marocaine ; d'après une dernière enquête du Haut Commissariat au Plan, les PME non organisées représentent environ 1,55 millions d'Unités et ont connu une augmentation d'environ 350 mille unités par an entre 1999 et 2007. Ce secteur est prépondérant dans le commerce (57,4%), les services (20%), l'industrie (20%) et les BTP (5,4%). Il utiliserait quelques 2,2 millions de personnes et représente 14,3% du PIB. Il couvre aussi bien les entreprises qui échappent au fisc et aux réglementations sociales que les activités de contrebande. Le dilemme, c'est qu'en dehors du fait que certaines pratiques ne relèvent pas de la compétence des autorités de la concurrence, c'est l'arbitrage entre l'emploi et la concurrence loyale qui est en cause. Comment faire alors ? La question reste posée.

Par ailleurs, des problèmes du même genre concernent même les PME travaillant dans la transparence ; celles-ci ont un rôle déterminant dans la promotion de l'emploi et la diffusion de l'innovation. Leur développement nécessite parfois des incitations, soit sous forme d'aides d'État, soit à travers la tolérance de certaines pratiques anticoncurrentielles comme certains niveaux et formes d'ententes. Jusqu'à quel niveau peut-on tolérer ce type de pratiques ?

La même question se pose aussi pour les champions nationaux : Certains d'entre eux tirent l'économie nationale vers le haut par la recherche, l'innovation et la compétitivité.

Dès lors, un certain nombre de questions se posent : Comment aider la recherche et la compétitivité en faisant un juste arbitrage entre celle-ci et la concurrence libre de toute entrave ? Comment, sous couvert d'aide à l'innovation et aux exportations, ne pas glisser vers des privilèges octroyés aux membres influents des organisations économiques ?

Enfin, à côté de ces données d'ordre structurel, certaines circonstances relevant de la conjoncture économique, comme c'est le cas de la dernière crise, peuvent justifier des régulations qui entravent ou freinent la logique concurrentielle. C'est ainsi qu'un plan global d'aide au secteur textile a été mis en œuvre. La question qui se pose est la suivante : Comment faire en sorte qu'on n'utilise pas la crise comme alibi pour revenir vers des pratiques protectionnistes permanentes ?

3.3 Concurrence, régulation et relations économiques internationales

Rappelons que depuis les accords de l'OMC, nous assistons à une libéralisation sans précédent des échanges. Celle-ci a été renforcée par de nombreux accords multilatéraux et bilatéraux. Le problème qui se pose concerne un certain nombre de dossiers qui soulèvent des difficultés certaines au niveau des relations commerciales internationales et des rapports Nord-Sud. Il s'agit principalement de trois dossiers : Les subventions agricoles, les exportations et le dumping social, le positionnement des cartels et de certaines grandes entreprises multinationales.

Concernant d'abord les subventions agricoles, elles concernent aussi bien le Maroc que ses partenaires. Il est à rappeler que dans le cadre du statut avancé, le Maroc a obtenu un délai de dix ans pour la mise à niveau de son agriculture vivrière et d'embouche sachant que ces activités concernent essentiellement le large et pauvre paysannat marocain. Par contre, l'agriculture dite moderne, essentiellement agrumicole et maraîchère, est performante, mais souffre plutôt de la politique agricole européenne commune qui pose des problèmes, malgré le relèvement des quotas il y a quelque temps, de barrières à l'entrée et des mécanismes de subvention de sa propre agriculture.

C'est une question majeure et sensible sur le plan sociopolitique pour tous les pays. En fait, ces subventions semblent handicaper en premier lieu certains pays du Sud dans le cadre des accords de libre échange signés avec le Nord. Il faut reconnaître qu'autant les subventions auxquelles ont recours les PED ont souvent un caractère social ou de survie, autant les aides d'État fournies à l'agriculture dans les pays du Nord occasionnent une concurrence dure à l'égard des productions des pays du Sud. La principale question qui se pose concernant ces aides a trait aux limites de cette transition.

La deuxième problématique concerne la promotion des exportations et le dumping social ; précisons que la promotion des exportations dans des pays n'ayant pas encore une culture de compétitivité, nécessite parfois un certain accompagnement, notamment par des incitations. Jusqu'à quel niveau peut-on tolérer de telles pratiques ?

Concernant plus particulièrement le dumping social, il s'agit de pratiques de bas salaires et surtout de non respect de la couverture sociale. Ceci cause évidemment une concurrence déloyale au dépend de certains pays. Précisons cependant que si de telles pratiques existent dans certains secteurs, on ne peut faire l'amalgame entre ces pratiques et la situation objective de bas salaire comme facteur de production compétitif. Sinon, pourquoi ne remettrait-on pas en cause l'avance technologique des pays industrialisés ?

De plus, concernant le cas du Maroc par exemple, on constate que le niveau relatif du SMIG marocain par rapport au SMIG français est peut-être relativement plus favorable aux exportations françaises puisqu'il est dans un rapport approximatif de 1 à 5 alors que le rapport des PIB/habitant est à peu près de 1 à 9.

On peut enfin invoquer le cas des cartels et des grandes entreprises multinationales ; il s'agit là d'un grand problème transnational qui s'opère au détriment des pays du Sud. En effet, certains cartels et grandes entreprises multinationales, à travers certaines aides d'État et à travers le jeu de leurs filiales, se partagent les marchés des pays en développement en tirant profit notamment de leurs carences notoires en matière de régulation de la concurrence. Que faire alors ? Et à quel niveau ?

4. Conclusion

En conclusion, malgré les difficultés objectives liées à toutes ces questions, on peut dire que la politique économique et sociale du Maroc durant cette décennie qui s'achève a été plus judicieuse quant à la recherche d'un équilibre entre politique de la concurrence et politique d'aides d'État, politique de croissance et politique d'action sociale et de lutte contre la pauvreté. Les équilibres fondamentaux sont préservés ; le taux de croissance moyen se situe autour de 5,5% ; le déficit budgétaire est maintenu dans des limites acceptables ; le déficit commercial, à l'exception de quelques difficultés résultant de la dernière crise, est compensé par les recettes touristiques et les transferts des marocains de l'étranger ainsi que par les investissements de l'extérieur. Tout ceci se réalise dans une ambiance de grands chantiers au niveau des infrastructures terrestres et maritimes ainsi qu'en ce qui concerne de grands projets industriels et touristiques. Précisons également que les chantiers d'action sociale se multiplient. Est-ce à dire que les choix se font en toute cohérence et qu'il ne subsiste pas de larges chantiers à mettre en œuvre ? Il me semble qu'il y a encore une culture régnante au niveau de la technocratie marocaine qui privilégie la politique d'aides d'État avec tout ce que cela entraîne comme difficultés d'efficience au détriment de la politique de la concurrence ; de même que, malgré tous les efforts entrepris sur les plans économique et social, se posent encore de sérieux problèmes au niveau du déficit de la balance commerciale, du système éducatif, de la gestion administrative, de la justice, de la persistance de certains îlots de pauvreté et de la montée de la corruption qui, si elle épargne certains milieux de la haute administration, semble toucher de larges franges de la société.

On est donc à la fin d'un processus de grands acquis managériaux tenant compte aussi bien de la politique de la concurrence que de la politique d'aides d'État. La prochaine décennie sera probablement, dans la même logique, la période des grandes réformes de structures.

PAKISTAN

I. The use of state aids in your country

1. *Does your country regularly engage into the following practices? If so, could you provide information about: (i) the affected sectors; (ii) an order of magnitude of the corresponding amounts, and (iii) the evolution over time? If possible, distinguish between government-owned and private firms.*
 - a. *Direct subsidies to companies;*
 - b. *Tax breaks to selected companies or selected sectors;*
 - c. *The granting of government-owned inputs (such as land, bandwidth, government facilities) to companies at a price below market levels (possibly a regulated price);*
 - d. *Government purchases at above-market prices;*
 - e. *The granting of loans at below-market rates;*
 - f. *The provision of loan guarantees at below-market rates.*

Direct subsidies have been provided to:

Pakistan International Airlines (PIA), a state-owned company, received around PKR 1 billion (USD 11.8 million¹) from the government for mark-up reimbursement during 2008-09.²

Sugar sector – The government provided a subsidy of one billion rupees on sugar to ensure its availability at PKR 38 (USD 0.45) per kilogram at all Utility Stores Corporation outlets.³ In the budget for FY 2009-10, subsidy for sugar import would be reduced to PKR 4 billion (USD 47.3 million) against PKR 6.3 billion (USD 74.5 million) in FY 2008-09.⁴

Fertilisers – In the Federal Budget for FY 2009-10, Fauji-Jordan Fertiliser Corporation, a private fertiliser manufacturing company, was allocated PKR 210 million (USD 2.49 million) as subsidy compared to PKR 231 million (USD 2.73 million) allocated in FY2008-09.⁵

¹ US Dollar equivalents calculated using exchange rate (1USD = PKR 84.50) on 1 January 2010 - adapted from <http://www.forex.pk/open-rates.php>.

² <http://pakobserver.net/200906/13/Articles03.asp>.

³ http://www.thenews.com.pk/daily_detail.asp?id=208426.

⁴ http://www.brecorder.com/latestindex.php?latest_id=10336&cindex=29¤t_page=2.

⁵ *Id.*

2. *To what extent have state aids in your country been motivated by the following goals? For each of them, please specify whether domestic and foreign firms have been treated differently.*
- a. *Protecting employment (in the case of aid to ailing firms);*
 - b. *Fostering innovation and the development of new sectors;*
 - c. *Attracting firms to economically distressed regions;*
 - d. *Remedying competition distortions created by the granting of aid by foreign governments;*
 - e. *Inducing firms to supply goods or services deemed to contribute to the general interest in cases when market incentives alone were insufficient to ensure that these goods or services would be provided;*
 - f. *Palliating the undersupply of credit by the financial sector;*
 - g. *Preventing strategic firms from being purchased by foreign companies.*

State aid is extended to the national air carrier, Pakistan International Airlines (PIA) to overcome its financial liabilities. The employee to aircraft ratio of PIA is 1:418 while generally for an airline, the employee to aircraft ratio is between 1:130 - 1:170.⁶ This indicates that extending state aid in such a scenario is making an ailing situation worse.

State aid is often extended to help the end-consumer in case of vital commodities such as sugar, wheat and rice. Farmers can also purchase fertiliser at subsidised rates. However, in the case of powerful state-run players in a market, state aid is sometimes used to support otherwise failing or ailing organisations. Hence, the contribution of state aid towards innovation and development of state-run organisations is often limited, other than prolonging their inefficiencies.

N/A.

No.

Yes.

Yes.

No.

3. *What are your country's laws, and the actual practice, regarding the provision of government-owned or government-controlled inputs? In which circumstances is an auction process mandatory? In which circumstances does a non-discrimination clause apply? In practice, what is the prevalence of auctions? If possible, please provide information about the way in which the following inputs have been allocated.*
- a. *License to operate a mobile telephony network (with access to the corresponding bandwidth);*
 - b. *License to operate a television network;*
 - c. *Access to natural resources.*

License fees for Cellular Mobile Telephony Services (CMTS) are awarded through open bidding.⁷

⁶ http://www.dailytimes.com.pk/default.asp?page=2008%5C12%5C28%5Cstory_28-12-2008_pg5_13.

⁷ http://www.pta.gov.pk/index.php?option=com_content&task=view&id=303&Itemid=131.

The license fees, in fact, cover the fee for spectrum allocation for 15 years.

The fee structure for Satellite Television Licenses is as follows⁸:

Sr. No.	Category	Tariff
1	News / Current Affairs	License Fee: PKR 5.0 million (USD 59,172) Annual Renewal: PKR 1.0 million (USD 11,834) Other Charges: 5% of annual gross revenue as per audited accounts.
2.	Sports	License Fee: PKR 1.5 million (USD 17,751) Annual Renewal: PKR 0.7 million (USD 8284) Other Charges: 7.5% of annual gross revenue as per audited accounts.
3	Regional languages.	License Fee: PKR1 .0 million (USD 11,834) Annual Renewal: PKR 0. 5 million (USD 5,917) Other Charges: 5% of annual gross revenue as per audited accounts.
4.	Health/ Agro	License Fee: PKR 0.5 million (USD 5,917) Annual Renewal: PKR 0.3 million (USD 3550) Other Charges: 5% of annual gross revenue as per audited accounts
5.	Education	License Fee: PKR 0.5 million (USD 5,917) Annual Renewal: PKR 0.3 million (USD 3,550) Other Charges: 5% of annual gross revenue as per audited accounts.
6.	Entertainment	License Fee: PKR 1.5 million (USD 17,751) Annual Renewal: PKR 0.7 million (USD 8,284) Other Charges: 7.5% of annual gross revenue as per audited accounts.

Access to natural resources is provided under particular legislation and rules by the Ministry of Petroleum and Natural Resources for prospecting for gas and oil in the country. Any company, whether incorporated in Pakistan or abroad, may apply for a petroleum right - a reconnaissance permit, exploration license or development and production lease - in accordance with the Pakistan Petroleum (Exploration and Production) Rules 2009⁹. The Rules also state that “for grant of petroleum rights after the expiry of the lease period, the Authority (Director General Petroleum Concessions (DGPC) or any officer or authority appointed by the Authority to exercise the powers and perform the functions of the DGPC) shall invite bids one year before the end of the lease period from the companies participating in the lease area”¹⁰.

II. Aid to ailing companies, especially in the context of the financial crisis

1. *In the context of the financial crisis, did your country provide emergency aid to some companies? If possible, please provide information on:*

a. *Specific rescue measures for banks and other financial institutions;*

b. *Aid to industrial firms (for instance in the car industry).*

No aid was given to banks.

⁸ <http://www.pemra.gov.pk/pdf/Revision%20of%20tariff-STV%20new.pdf>.

⁹ http://202.83.164.26/wps/wcm/connect/?MOD=PDMPProxy&TYPE=personalization&ID=NONE&KEY=NONE&LIBRARY=%2FcontentRoot%2Ficm%3Alibraries%5B127%5D&FOLDER=%2FMinistry+of+Petroleum+and+Natural+Resources%2FDGPC%2F&DOC_NAME=%2FcontentRoot%2Ficm%3Alibraries%5B127%5D%2FMinistry+of+Petroleum+and+Natural+Resources%2FDGPC%2FRules+2009.pdf&VERSION_NAME=NONE&VERSION_DATE=NONE&IGNORE_CACHE=false&CONVERT=NONE&MUST_CONVERT=false.

¹⁰ *Id.*

Aid was granted to the national air carrier, Pakistan International Airlines.

2. ***What are the criteria that have been used when delineating the beneficiaries of emergency aid, as well as the amount or nature of the aid?***

No specific criteria.

3. ***Is aid to ailing companies in your country usually provided with conditions attached such as:***
- a. ***Clauses imposing at least partial reimbursement in the event of a return to better fortunes?***
 - b. ***A cap on executive pay?***
 - c. ***Restructuring (for instance, the closing of unprofitable factories or branches)?***
 - d. ***Guarantees on total employment?***
 - e. ***Clauses prohibiting the use of government funds in order to engage in predatory strategies?***
 - f. ***An explicit commitment that the aid will be limited in time and will not be repeated?***
 - g. ***Commitments regarding the environmental impact of the recipient's activity? Please provide short information on each of these provisions and the standard conditions attached to them.***

Generally, ailing companies do not receive help that includes such conditions. There are however, a few notable exceptions such as Pakistan International Airlines, which has approximately PKR 20 billion (USD 237 million) in debts.

4. ***Does aid to ailing companies in your country sometimes take the form of temporary government ownership in return for capital injection? If so, are there examples where such policies allowed the government to turn a profit after the aided firm's situation improved?***

No companies have been taken into partial or complete government ownership.

III. Legal restrictions on state aids

1. ***Do competition authorities exert some control on state aids in your country? If so, has this control been weakened in the context of the financial crisis? Are there specific rules about aid to ailing firms, or aid to R&D? Please detail each, briefly.***

There are no legal restrictions as such. The Government decides the extent of state aids on a case by case basis. The Textile sector in Pakistan had been allocated PKR 4 billion (USD 47.3 million) as the Research and Development (R&D) facility for this sector in FY2008-09. In the FY2009-10 budget, this R&D facility was withdrawn by the government. The three percent mark-up subsidy (to assess the impact of interest rate) to the spinning sector has now also been reduced to PKR 500 million (USD 5.92 million) from PKR 810 million (USD 9.59 million) in FY2008-09. In order to help the textile and other export industry, PKR 40 billion (USD 473 million) export investment fund is proposed to be established, from which around PKR 27 billion would go to cotton and textiles while the remaining PKR 13 billion (USD 153 million) would go to other export sectors to boost export earnings.¹¹

¹¹ http://www.brecorder.com/latestindex.php?latest_id=10336&cindex=29¤t_page=2.

R&D support of 6% was allowed on the export of readymade textile garments from Export Processing Zone units with effect from April 14, 2006 as per rules and regulations.¹²

2. ***Is the amount and nature of state aids limited by virtue of regional trade agreements to which your country participates (not taking into account WTO disciplines)? If so, is there a supranational control mechanism? Has it ever been used? In competition cases?***

No.

3. ***Did the competition authority in your country ever have to consider a case involving state aids? If possible, please distinguish the following (possibly overlapping) types of cases:***

- a. ***A private company complaining about predatory strategies (or unfair practices) implemented by a public company or by a private company benefiting from public funds (for instance in the case of a firm providing a public service and using the corresponding revenues in order to compete aggressively on another market);***
- b. ***A company complaining about discriminatory treatment, in comparison to a competitor benefiting from state aids;***
- c. ***Cases involving the existence of price regulation;***
- d. ***Cases involving abuse of dominance or merger cases (for example, in the latter, would remedies be affected if the state aid were to be withdrawn?).***

No

4. ***Are government-owned companies subject to competition law to the same extent as private companies in your country? Are there any specific mechanisms for their implementation?***

Government-owned companies in Pakistan are subject to competition law to the same extent as private companies in the country. Section 2(p) of the Competition Ordinance, 2009 (“the Ordinance”) defines an undertaking in the following words: “any natural or legal person, governmental body including a regulatory authority, body corporate, partnership, association; trust or other entity in any way engaged, directly or indirectly, in the production, supply, distribution of goods or provision or control of services and shall include an association of undertakings”. These undertakings are required to observe the laws stated in the Ordinance.

5. ***To what extent are state aid issues addressed in your competition authority’s advocacy activity? What is your competition authority’s message on state aids? Is this message well understood and taken duly into account by other parts of the government? Please describe briefly the relevant institutional mechanism(s), if any.***

In case a state aid plan with anticompetitive effects is being implemented by the government, the Competition Commission of Pakistan can intervene by holding public hearings and issuing policy recommendations on how the government should proceed to protect competition in the market and safeguard interests of the consumers. However, since competition law is relatively new in the country, the basic focus of advocacy activities is making the foundation principles of competition law known to the businesses and the public.

¹² <http://www.sbp.org.pk/EPD/2006/FECL24.htm>.

PERU

1. Introduction

This paper presents an overview of the uses, justifications and legal restrictions on State Aids in Peru. It has been written to be presented as a country contribution to Session I of the IX Global Forum on Competition, organized by the OECD Competition Committee.

State Aids are an important part of the policy tools used by Governments elsewhere to achieve different goals such as inducing firms to innovate or to export, alleviate economic deprived regions or palliate market failures. In the context of the current financial crisis, the use of State Aids have been multiplied as Governments have faced the need to rescue financial institutions and other industrial firms through direct transfers and even taking the temporary ownership of these distressed firms.

While the goals of State Aids are varied and perhaps justified in certain circumstances, it is widely recognized that State Aids could also distort competition. The EU rules on State Aids and The World Trade Organization rules on Government subsidies are clear examples of these concerns at an international level. At a national level, there is less evidence regarding the existence of legal restrictions on State Aids.

Through various State Aid examples, this paper shows the different uses and justifications for State Aids in Peru. It also analyses the legal restrictions currently in place for controlling the use of State Aids, in particular when the Government proposes to develop business activities either directly or indirectly. However, it is worth stressing that this paper does not intend to provide an exhaustive list of the different State Aids currently in practice or a judgment about their benefits or their impact on competition. Following the suggested questions provided by the OECD Competition Committee, the paper has been structured as follows:

- Section 2, presents an overview of the types of State Aids currently used in Peru as well as the goals that support the introduction of these aids;
- Section 3 describes the current types of State Aids used for palliating the effect of the international financial crisis; and
- Section 4 presents an analysis of the legal restrictions currently in place for controlling State Aids and their impact on competition. The final section summarizes the paper and presents our conclusions.

2. The use of state aids in Peru

2.1 *Overview of state aids used in Peru*

Since the nineties, Peru has undertaken several market reforms with the aim of levelling the playing field for the development of private businesses, reducing the State's role as a business agent and reserving the Government participation only to specific areas such as health, education, promotion of employment, national security, utilities and infrastructure.

The Peruvian Political Constitution of 1993 recognizes the principle of free private enterprise within a social market economy. Legislative Decrees 668 and 757 further approved measures to guarantee the freedom of foreign and domestic trade, eliminated monopoly practices in the production or selling of goods and services, established that the State guarantees the freedom of private initiatives based on free competition and access to economic activities and abolished any exclusivity rights granted to the State for the development of economic activities, stressing that private and state-owned firms would receive the same legal treatment.

Although overall it is possible to sustain that, compared to previous decades, the use of State Aids in Peru has declined since the nineties; there are various forms of State Aids (especially tax breaks) still functioning in Peru.

2.1.1 *Tax breaks*

In the case of tax breaks, a report for the Ministry of Economy and Finance by Apoyo Consultoría (2003) detected up to 193 tax breaks. According to Apoyo Consultoría (2003), most of the tax breaks were concentrated in two taxes: the general sales tax (35,5%) and the income tax on legal persons (33,5%). The study also showed that tax breaks were common for taxes that applied to all the economy (21,2%), as well as for the financial industry (17,2%), businesses located in the jungle (11,3%), education (11,3%) and agriculture (6,4%). Table 1 summarizes the tax breaks situation up to year 2003 taking into account the name of the tax, the type of benefit and the economic sector involved. It is worth noting that the study concluded that the access to tax breaks was independent of the investment level and, in some cases, they did not promote the increase in value added of the sector or region benefited.¹

¹ Apoyo Consultoría (2003). *Análisis de las exoneraciones e Incentivos Tributarios y Propuesta de Estrategia para su Eliminación*. Document prepared for the Ministry of Economy and Finance. Available in: http://www.mef.gob.pe/INFECO/documentos/DOCUMENTO_FINAL_JUNIO03.pdf (Last visited: 3 January 2010).

Table 1. Tax Breaks in Peru up to 2003
(number of benefits by tax, type and sector)

Tax	Type / Sector	General application	Agricultural	Jungle	CETICOS	Construction	Education	Energy	Financial	Hydrocarbons	Industrial	Mining	Other Sectors	Transport	Tourism	Total
Solidarity tax for Helpless Children	Exemptions	3														3
Ad Valorem Customs Duties	Exemptions				1					1						2
	Temporary Importation									1					1	2
	Unaffected	4	1		1		2						1			9
	Other Tax Expenses		1													1
	Special or Reduced Rates	1														1
Income Tax on Legal Persons	Credits			1			1									2
	Deductions	2	1	1			1			1		1				7
	Deferments		1			2			2	4		2	1		3	15
	Exemptions	4		1	2		4		13							24
	Unaffected	5					1									6
	Simplified Regime	1														1
	Reduced Rates		1	7												8
Income Tax on Natural Persons	Deductions	1		1			1									3
	Exemptions						2		9							11
	Unaffected	6														6
Special Solidarity Tax	Exemptions		1	1	1											3
	Unaffected	1					1									2
	Differential Rates					1										1
General Sales Tax	Credits			1												1
	Deductions					1										1
	Returns	3	1	2						2		2	3		3	16
	Exemptions	2	2	4	2	1	3		9	1	2	2	1	3		32
	Temporary Importation									1					1	2
	Unaffected	4			2		4		2	1			1		2	16
	Other Tax Expenses	2	1													3
Excise Tax	Returns			1									1			2
	Exemptions			3	3			1								7
	Temporary Importation														1	1
	Unaffected	1								1						2
	Reduced Rates				1								1			2
Other taxes	Other Tax Expenses	1														1
Total		41	10	23	13	5	20	1	35	13	2	7	9	3	11	193

Source: Apoyo Consultoría (2003).

2.1.2 Direct subsidies

Direct subsidies are used in social programs for the poor and are focused to the target population. To our knowledge, no direct subsidies are currently granted to state-owned and/or to private companies. Moreover, the Ministry of Economy and Finance is implementing a budget for results for the national budget, which will further contribute to make any direct subsidy transparent and linked to a performance measure.

2.1.3 *Government purchases*

Government purchases are ruled by the State Procurement Law (Legislative Decree N° 1017) and its Regulations (Supreme Decree N° 184-2008-EF). According to these laws, all public procurement contracts must consider criteria of speed, economy and efficacy, thereby ruling out the possibility of the Government purchasing at above market price to benefit certain sector or companies.

Notwithstanding this, there are some other forms of State Aids in Government purchases aimed to help small enterprises. For example, according to the State Procurement Law, winning bidders must give to the contracting authority a Guarantee of Faithful Compliance equivalent to ten percent (10%) of the original contract amount before signing the contract. However, in the case of regular supply of goods or services, as well as in consulting contracts and public works, small enterprises can ask the contracting authority to retain ten percent from the contract payment, in practice waiving the need of presenting the Guarantee of Faithful Performance in advance of signing the contract.

2.1.4 *The granting of Government-owned inputs*

Government-owned inputs such as land and bandwidth are granted to private companies through concession processes, some of which involve auctions. PROINVERSION is the Peruvian investment promotion agency in charge of promoting private initiatives that involve government-owned inputs. In addition to PROINVERSION, other sector specific laws rule the concession of other natural resources such as forest lands, oil and gas, fisheries, etc. For instance, in the case of forest lands, the main objective of the concessions is to ensure the sustainable management and conservation of forest resources.² Forest concessions are given to private parties for the preferential use of wood through a public auction or a public tender for a renewable period of up to 40 years.³

When the concession process involve the setting of a regulated price, this is not normally set below market prices. However, it is worth mentioning the concession of a landmark natural gas project in the late nineties, where the Government established a price for the natural gas which is lower for electricity generators than for other gas users (petrochemical, industrial and commercial users).

2.1.5 *The granting of loans*

Regarding the granting of loans, the Peruvian government does not grant loans at below-market rates and it does not provide loan guarantees at below-market rates. It does, however, intervene in the financial market mainly through four institutions: Banco de la Nación, COFIDE, Agrobanco and Mivivienda.

- Banco de la Nación⁴ is a government owned bank which manages the accounts of the Treasury and the Central Government in order to provide banking services for the administration of public funds. Through this bank, the State grants loans to both firms (MSEs) and citizens. Loans are provided at market-rates, which depend on the type of loan and are not necessarily are the lowest in the market.
- COFIDE (Corporación Financiera para el Desarrollo)⁵ is a second-tier development bank that is partially owned by the government (98,7%)⁶ and channels resources from multilateral agencies,

² Law N°27308, Forest and Wildlife Law.

³ The Surveillance Agency of Forest Resources and Wildlife (<http://www.osinfor.gob.pe/>) is the entity responsible for the management and administration of forest resources and wildlife nationwide.

⁴ <http://www.bn.com.pe/>

⁵ <http://www.cofide.com.pe/>

government agencies, commercial banks and local capital market to intermediary financial institutions. COFIDE does not require guarantees and it does not set the interest rates that are charged to the final beneficiaries of the loans, since these are responsibilities of the first-tier banks, which are also responsible for the risk of the credit transactions.

- AGROBANCO (or Banco Agropecuario) is a bank that grants direct and indirect loans to firms devoted to agriculture, livestock, aquaculture and the processing and marketing of products of agriculture and aquaculture. Direct loans are granted to small producers who are organized in supply chains and receive supervision, technical assistance programs and agricultural insurance in order to achieve economies of scale, reduce costs, maximize profits and promote the existence of better credit subjects. Indirect loans are granted through special financing programs with financial intermediaries (such as banks, multiple banks, rural banks, local banks and EDPYMES⁷).
- Finally, Fondo Mivivienda is a mortgage fund for the promotion of housing. Its objective is to engage in the promotion and financing of the acquisition, improvement and construction of housing, especially in cases of social interest. It also aims at organizing activities related to enhancing the flow of capital to the housing finance market, participating in the primary and secondary market of mortgage loans and helping the development of the mortgage market.⁸

2.2 *Goals pursued by State Aids in Peru*

There are several goals that are usually pursued by governments when providing State Aids. As it will become clear from the following selected examples, in Peru the granting of State Aid have followed different purposes.

2.2.1 *Attracting firms to economically distressed regions*

With the objective of promoting investments in the Peruvian jungle, Law N° 27037 “Law on Investment Promotion in the Amazon”, establishes tax exemptions to firms that are located in the Amazon⁹ and perform the following economic activities: agriculture, aquaculture, fisheries, tourism and manufacturing activities related to processing, transformation and commercialization of primary products from the above activities, provided that such activities are performed in the area.

This law provides four types of tax breaks:

- The income tax is reduced to 10%, 5% and 0%, depending on the province and the economic activity.

⁶ The remaining 1,3% belongs to Corporación Andina de Fomento (CAF), a multilateral financial institution that mobilizes resources from international markets to Latin America, in order to provide multiple banking services to both public and private clients of its shareholder countries.

⁷ EDPYMES are financial firms that are dedicated to granting loans to small and medium enterprises.

⁸ <http://www.mivivienda.com.pe/>

⁹ The law is applied in the following regions: a) departments of Loreto, Madre de Dios, Ucayali, Amazonas and San Martín; b) department of Ayacucho: the districts of Sivia and Ayahuanco in the province of Huanta, and the districts of Ayna, San Miguel and Santa Rosa in the province of La Mar.; c) department of Cajamarca: the provinces of Jaén and San Ignacio; d) department of Cusco: the district of Yanatile in the province of Calca; the province of La Convención; the district of Koshiñpata in the province of Paucartambo, and the districts of Camanti and Marcapata in the province of Quispicanchis and e) department of Huánuco: the provinces of Leoncio Prado, Puerto Inca, Marañón and Pachitea; the district of Monzón in the province of Huamalíes; the districts of Churubamba, Santa María del Valle, Chinchao, Huánuco and Amarilis in the province of Huánuco, and the districts of Conchamarca, Tomayquichua and Ambo in the province of Ambo.

- The sales tax is not charged in the following cases: (i) the sale of goods that are produced in the same region, (ii) the services provided in the region, and (iii) the construction contracts or the first sale of properties that were built by the builders in that area. For all the other activities named above, there is a special tax credit for the determination of the sales tax that applies to the sale of goods outside this area.
- The sales tax and the excise tax on oil, natural gas and its derivatives is not charged to firms that are located in the departments of Loreto, Ucayali and Madre de Dios.
- Firms that are located in the jungle are exempted from the Extraordinary Solidarity Tax and Special Tax on Net Assets.

The Law on Investment Promotion in the Amazon was first enacted on December 30th 1998 and, even though it was attempt to terminate the tax breaks benefits in March 2007, the Law returned into force on 1 October 2009.

Another recent example of the use of tax breaks as a mean for attracting firms to economically distressed regions is Law N° 29482 enacted on December 18th 2009 to promote the development of productive activities in the Highlands of Peru. This law establishes an exemption from three types of taxes to all micro and small enterprises, cooperatives, community and multicomunity enterprises that are located 2 500 meters above sea level and higher, as well as to all firms that are located 3 200 meters above sea level and higher. The taxes that are exempted are:

- The income tax on the third-income category.¹⁰
- Tariff rates on the import of capital goods.
- The sales tax on the import of capital goods.

2.2.2 Inducing firms to supply goods or services deemed to contribute to the general interest in cases when market incentives alone were insufficient to ensure that these goods or services would be provided.

The Political Constitution of 1993 allows the participation of the State in the provision of goods and services in cases where market incentives alone are insufficient to ensure that these goods or services would be provided, as long as the State intervention is authorized by means of a special law, the Government activity is “subsidiary” and there is an overriding “public interest” or “manifest national benefit” supporting the State intervention.

A recent example of the use of this type of justification for granting the State participation in business activities is a proposed law, currently debated in the Congress, for creating a commercial airline through a public-private partnership, where the State will end up having a control stake in the airline. The aim of the proposed law is to create an airline that could provide trips to destinations currently not covered by private airlines. In addition, the proposed law also aims at reducing the fares currently charged by the private airlines in other destinations served by private airlines.

¹⁰ The third category income includes: (i) the income from commerce, industry and mining, as well as from the exploitation of natural resources, services and any other regular businesses of production or sales; (ii) the income from activities of intermediary trade agents, auctioneers and all other similar activities; (iii) the income from Notaries.

2.2.3 *Remedying competition distortions created by the granting of aid by foreign governments.*

The Anti-Dumping and Countervailing Duties Commission of the National Institute for Defense of Competition and Protection of Intellectual Property (INDECOPI) is in charge of enforcing the rules addressed at preventing and correcting competition distortions generated by the goods imports that are either subsidized or imported with a dumping price, according to the rules and procedures as stipulated in the World Trade Organization agreements and Supreme Decrees N° 006-2003-PCM and 133-91-EF.¹¹

Under these laws, national producers who consider that they have been damaged or threatened by the import of similar products which are subsidized by foreign governments can submit a request to the Commission for the opening of an investigation to determine the existence of the alleged practice, as well as the damage caused to national production as a result of such import. The Commission can impose countervailing duties to the subsidized imports as a remedy.

The Commission started its activities in 1992 and since then it has conducted nine investigations about subsidies, three of which are still under investigation.¹² Furthermore, countervailing duties were imposed in three cases: candies from Argentina; vegetable oils, refined and packaged, from Argentina and olive oil from the European Union.

2.2.4 *Other goals*

Other goals typically pursued by governments when extending State Aids are the protection of employment, preventing strategic firms from being purchased by foreign companies and fostering innovation and the development of new sectors.

Regarding these other types of State Aids, it is worth mentioning a State Aid program recently created as a result of the Free Trade Agreement signed with the United States. This State Aid programs aims to increase the competitiveness of small and medium agricultural producers, fomenting the adoption of new technologies. The program has duration of five years and consists of transfers to incentive the association of small and medium producers, the adoption of best management practices and the implementation of new technologies.¹³

3. **Aid to ailing companies in the context of the financial crisis**

The financial crisis certainly affected the Peruvian economy; however, according to several sources, Peru was one of the least affected countries in Latin America¹⁴. In fact, it was because of its ability to withstand external shocks that Moody's Investors Services recently raised the credit rating of Peru to investment grade, following other credit ratings agencies.¹⁵ Taking this into account, there was no need to provide transfers to banks or any other financial institution or firm, as it have been the case elsewhere due the financial turmoil. In contrast, the measures adopted by the Peruvian government in order to face the financial crisis were a mix of fiscal and monetary stimulus plus programs targeted to small and medium exporting and agricultural firms.

¹¹ http://www.indecopi.gob.pe/0/modulos/JER/JER_Interna.aspx?ARE=0&PFL=1&JER=852

¹² The second and administrative instance of INDECOPI (Defense of Competition Chamber N° 1) is reviewing one of these investigations.

¹³ This program, called "Programa de Compensaciones para la Competitividad" was created by Law Decree 1077.

¹⁴ For instance, see: <http://www.globalviewc.com.ar/files/article/file/30.pdf>.

¹⁵ See: <http://semanaeconomica.com/articulos/47923-moody-s-otorga-grado-de-inversion-al-peru-por-su-capacidad-para-resistir-shocks-externos>

One of these programs was the creation of Fondo AGROPERU¹⁶, a PEN 200 million fund destined to give a guarantee for farmers that intend to invest in planting new crops. The fund is managed by AGROBANCO and aims at reducing the negative impact of financial crisis in agriculture, enhancing technological change and modernizing fields in order to increase the supply of exportable agricultural products to international markets.

Another example of State Aid in the context of financial crisis was the Business Guarantee Fund (*Fondo de Garantías Empresariales* – FOGEM) amounting a total of PEN 300 million in order to ensure that the national financial system grants credit for micro and small enterprises devoted to services and trade, and for median enterprises which are engaged in the production of goods or services within non-traditional exports chains.¹⁷ This is a temporary fund which is supposed to last only two years and since its creation it has been guaranteeing up to 50% of loans for working capital or fixed asset acquisition, taken by micro, small and medium enterprises, whose direct or indirect sales abroad exceeding 30% of their annual income. Nonetheless, because of the relatively low impact of the crisis on the Peruvian economy, the demand for guarantees has been low.¹⁸

4. Legal restrictions on state aids

State Aid is defined in the European Union (EU) legislation as “any aid granted by a Member State, or through State resources, which distorts or threatens to distort competition by favouring certain firms or the production of certain goods”.¹⁹ State Aids are controlled in the EU to ensure that government interventions do not distort competition and trade inside the union, however recognizing that, in some circumstances, government interventions is necessary for a well-functioning and equitable economy.²⁰

Unlike the EU, where the impact on competition is crucial on assessing the granting of a State Aid, in Peru there is no specific legislation that requires considering the impact on competition when granting a State Aid. Instead, the Peruvian Constitution requires the State to follow three criteria for assessing its participation (directly or indirectly) in business activities.²¹

- First, the State participation in business activities should be authorized by a special law;
- Second, the State participation in business activities should be **subsidiary** to private businesses; i.e., the State intervention should not foreclose private businesses from the market.
- Third, State participation in business activities can only by allowed for reasons of overriding **public interest** or manifest **national benefit**.

¹⁶ The fund was created by means of the Emergency Decree 027-2009, which was published on 23 February 2009.

¹⁷ Emergency Decree N° 024-2009, published on 20 February 2009.

¹⁸ See: <http://gestion.pe/impresanoticia/crisis-no-golpea-mucho-empresas-lo-que-banca-no-pide-mas-garantias/20-09-09-15/8936>

¹⁹ Article 87 EC.

²⁰ http://ec.europa.eu/competition/state_aid/overview/index_en.html

²¹ Article 60 of Peru Constitution:

“The government recognizes economic pluralism. The national economy is based on the coexistence of several forms of ownership and enterprise.

Authorized solely by an express law, the government may subsidiarily engage in business activities, directly or indirectly, for reasons of overriding public interest or manifest national benefit.

Business activity receives the same legal treatment, whether public or private.”

In contrast to the EU State Aid rules, the above criteria as applied in Peru does not specifically address competition concerns, although some sort of competition advocacy analysis should be involved in analyzing whether the State intervention is foreclosing private businesses or not. The **subsidiary** criterion is also less broad than the EU State Aid concept, as it is only applied to situations where the Peruvian State develops entrepreneurial activities; i.e., it does not cover other types of State Aids.

In mid 2008, a new Law regulating unfair competition acts as well as infringements to rules that regulate commercial advertising was enacted (Legislative Decree No. 1044 - Law on Overseeing of Unfair Competition). Under this Law, The Overseeing of Unfair Competition Commission of INDECOPI is in charge of analyzing the subsidiary role of State agencies or firms.

To date, there have been six cases brought to this Commission under the new Legislative Decree N°. 1044, in which the plaintiffs claimed that a State-owned hospital was providing medical services to patients which otherwise will be attended in private hospitals. Other cases involved the participation of a State-owned company in a concession process for developing a new power plant and a State-owned university which operated a restaurant outside the campus, competing with similar restaurants in the area. In all these cases the Commission supported the plaintiff's claims because the State-owned entities failed to meet the first criteria of having a special law enabling the defendants to develop private businesses. Therefore in all these cases it was not necessary for the Commission to analyze whether the services provided by the State-owned entities were **subsidiary** and in the **public interest**.

Before Legislative Decree N° 1044 was enacted, INDECOPI was required by FONAFE (a holding of state-owned firms) to assess whether 13 state-owned companies²² meet the above three criteria. In seven cases it was concluded that at least one of the activities developed by these firms could be offered by the private sector without the need of these state-owned firms. Only two of these companies are currently not operating: TANS (a former state-owned airline) and CONEMINSA (a multiservice firm). According to INDECOPI's analysis, some of the activities of these firms could be partially covered by the private sector in the case of TANS and fully covered by the private sector in the case of CONEMINSA.²³

It is worth mentioning that the Peruvian Defense of Free Competition Commission (also part of INDECOPI) has no specific powers for exerting control over State Aids in Peru. Notwithstanding this, the powers of this Commission for detecting and sanctioning anticompetitive conducts are applicable to private as well as state-owned firms.

At an international level, as member of the Andean Community Peru must comply with The Andean Community Regulations, which include both a Decision concerning the protection and promotion of free competition (Decision 608²⁴) and a Decision which aims at preventing or correcting the distortions in competition generated by subsidies in imports that are produced in Member States (Decision 457²⁵). None of these decisions directly limit the amount and nature of State Aids. There is, however, a provision in the first one according to which Member States should not impede, hinder or distort competition in the regional market (see Article 36), but to date there has not been any case relating to the matter of State Aids.

²² Servicios Postales del Perú – SERPOST S.A., Transportes Aéreos Nacionales de la Selva – TANS S.A., Editora Perú S.A., Servicios Industriales de la Marina - SIMA Perú S.A., Servicios Industriales de la Marina - SIMA Iquitos S.R.L., Inmobiliaria Milenia S.A., Empresa de Administración de Infraestructura Eléctrica – ADINELSA S.A., Empresa Nacional de la Coca – ENACO S.A., Perupetro, Corporación Financiera de Desarrollo – COFIDE S.A., Compañía de Negociaciones Mobiliarias e Inmobiliarias - CONEMINSA, Banco de la Nación S.A. and Banco de Materiales S.A.C.

²³ A overview of the methodology followed to determine the subsidiary role of these State-owned companies is provided in the Appendix.

²⁴ <http://www.comunidadandina.org/normativa/dec/D608.htm>

²⁵ <http://www.comunidadandina.org/normativa/dec/D457.htm>

5. Conclusions

This paper presents an overview of the State Aids uses in Peru. It has been shown, based on various State Aid examples, that the uses of State Aids in Peru are varied and, although overall, the number of State Aids appears to be reduced compared to previous decades, there are still in place many forms of State Aids, in particular tax breaks.

The many uses of State Aids in Peru are supported by different goals; these are mainly related to the promotion of economic activities in specific regions (such as the highlands and the jungle) and/or for specific sectors (agricultural firms or small-medium exporters).

State Aids in the form of Government-owned inputs granted at below-market levels or loans and loan-guarantees granted at below-market rates are less commonly used in Peru. It has been shown that in the case of Government-owned inputs, these are normally transferred to private operators through a concession process and, depending on the scarcity of the input, through an auction. In the case of loan and loan-guarantees, the Government intervenes directly through first and second-tier state-owned banks; however the rates charged are not below market rates.

In the context of the current financial turmoil, State Aids in the form of specific rescue measures to financial institutions and other industrial firms have not been used in Peru. Instead, the Government has focused its strategy on a mix of fiscal and monetary policy, combined with target aids to agricultural and small exporters firms, through special funds: The Business Guarantee Fund (*Fondo de Garantías Empresariales* – FOGEM) and Fondo AGROPERU.

Finally, at a national or international level, there is no legal restriction imposed on the Peruvian Government on the use of State Aids (aside for the case where the State Aid is in the form of a subsidy that affects a third country under the rules of the World Trade Organisation).

Although there is no legal binding to the use of State Aids, the Government has restrictions on the developing of business activities. According to the Peruvian Constitution, the Government have to follow three criteria for assessing its participation (directly or indirectly) in business activities.²⁶

- First, the State participation in business activities should be authorized by a special law;
- Second, the State participation in business activities should be **subsidiary** to private businesses; i.e., the State intervention should not foreclose private businesses from the market.
- Third, State participation in business activities can only be allowed for reasons of overriding **public interest** or manifest **national benefit**.

In contrast to the EU State Aid rules, the above criteria as applied in Peru does not specifically addresses competition concerns, although some sort of competition advocacy analysis should be involved in analyzing whether the State intervention is foreclosing private businesses or not. The **subsidiary** criterion is also less broad than the EU State Aid concept, as it is only applied to situations where the Peruvian State develops entrepreneurial activities; i.e., it does not cover other types of State Aids.

²⁶

Article 60 of Peru Constitution:

“The government recognizes economic pluralism. The national economy is based on the coexistence of several forms of ownership and enterprise.

Authorized solely by an express law, the government may subsidiarily engage in business activities, directly or indirectly, for reasons of overriding public interest or manifest national benefit.

Business activity receives the same legal treatment, whether public or private.”

APPENDIX: METHODOLOGY FOR THE ANALYSIS OF THE SUBSIDIARY ROLE OF GOVERNMENT BUSINESS ACTIVITIES

The analysis included three steps: analysis of competition conditions, analysis of the availability of supply by private firms and analysis of possible results if the state-owned firms ceased to operate (scenario analysis).

1. Analysis of Competition Conditions

The analysis of the competition conditions starts with the identification of the main physical and technical characteristics of the product or service supplied by the state-owned firm, as well as its final uses. This first step aims at determining if there are private firms competing with the State-owned company. Afterwards, two aspects are assessed:

- Characteristics of the market and current market conditions.
 - Size and trends in demand, that is, if the demand is increasing or decreasing given that this influences the number of potential or actual participants in the market.
 - Dynamics of entry and exit of competitors in the market in order to characterize the firms in the market, market power and the importance of potential competition.
 - Specific demand characteristics (existence of seasonality, regular or occasional purchases, market segmentation, exclusive supply contracts, etc.) that may influence the competition conditions and the definition of markets.
- Existence of barriers to entry and exit.
 - Legal and/or administrative barriers.
 - Structural barriers: absolute cost advantages, economies of scale and scope, existence of essential facilities, network externalities, sunk costs.
 - Strategic or behavioural barriers: strategic behaviour aimed at deterring entry by potential competitors (price limit, over-investment in capacity, product differentiation, integration and vertical restraints) and barriers aimed at excluding competitors and market place (increase in costs of rivals, predatory pricing).

2. Analysis of supply conditions of private firms

Two alternative methods are used in order to assess the supply of private firms:

- *Comparing the available private supply (APS)¹ against the total market demand.* Three cases can be identified:

APS > Maximum demand → No subsidiary role → End of the analysis

$\begin{matrix} > \\ < \end{matrix}$ Average demand
 APS < Maximum demand → Supply capacity of private firms is not proved → The analysis continues

APS < Average demand → Supply capacity of private firms is not proved → The analysis continues

- *Evaluating whether private companies can meet the demand of the state-owned firm, if the latter cease to operate in the market:* In this case the capacity of private firms to cover the market demand is determined by taking into account the margin between installed capacity and capacity utilization of each company; that is, between the maximum potential supply and the current supply of private companies involved in the industry.² Afterwards, the absorption capacity is compared with the demand covered by the state-owned firm (which would have to be covered by private firms in case the state-owned firm left the market) in order to determine if the company is playing a subsidiary role or not.

3. Analysis of scenarios

Depending on the number of private firms participating in the market, the analysis is performed in four different scenarios:

- *Scenario 1:* Only the state-owned firm provided the good or service.
- *Scenario 2:* A state-owned firm and a private firm provided the good or service.
- *Scenario 3:* A state-owned firm and two private firms (which are not part of the same economic group) provided the good or service.
- *Scenario 4:* A state-owned firm and three or more private firms provide the good or service.

¹ The available private supply is defined as the maximum supply of private firms currently participating in the market, given their installed capacity:

$$APS = \sum_{i=1}^n IC_i$$

Where: APS = available private supply
 IC_i = installed capacity of firm *i*

² The absorption capacity of private firms was calculated in the following manner:

$$AC = \sum_{i=1}^n (IC_i - UC_i)$$

Where: AC = absorption capacity of private firms
 IC_i = installed capacity of firm *i*
 UC_i = used capacity of firm *i*

The existence of enough private supply to cover the market demand is presumed when two or more private companies operate in the market, that is, in Scenarios 3 and 4.³ However, if in Scenarios 3 and 4 there is a reasonable doubt about the ability of private firms to supply the market, then the analysis continues in order to find evidence as to whether the business activity of the State plays a subsidiary role to private initiative or not. Figures 1 and 2 show the analysis performed by INDECOPI in each scenario.

Figure 1. Analysis of the subsidiary role of state-owned firms in Scenario 1

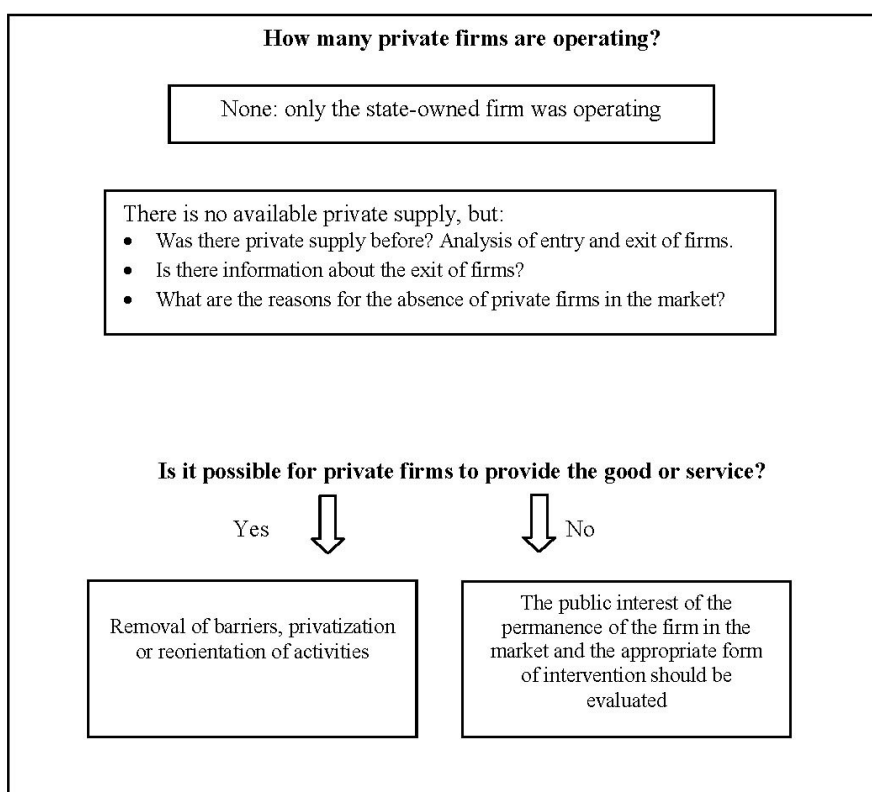

³

This assumption was derived from See Supreme Decree N° 034-2001-PCM.

Figure 2. Analysis of the subsidiary role of state-owned firms in Scenarios 2, 3 and 4

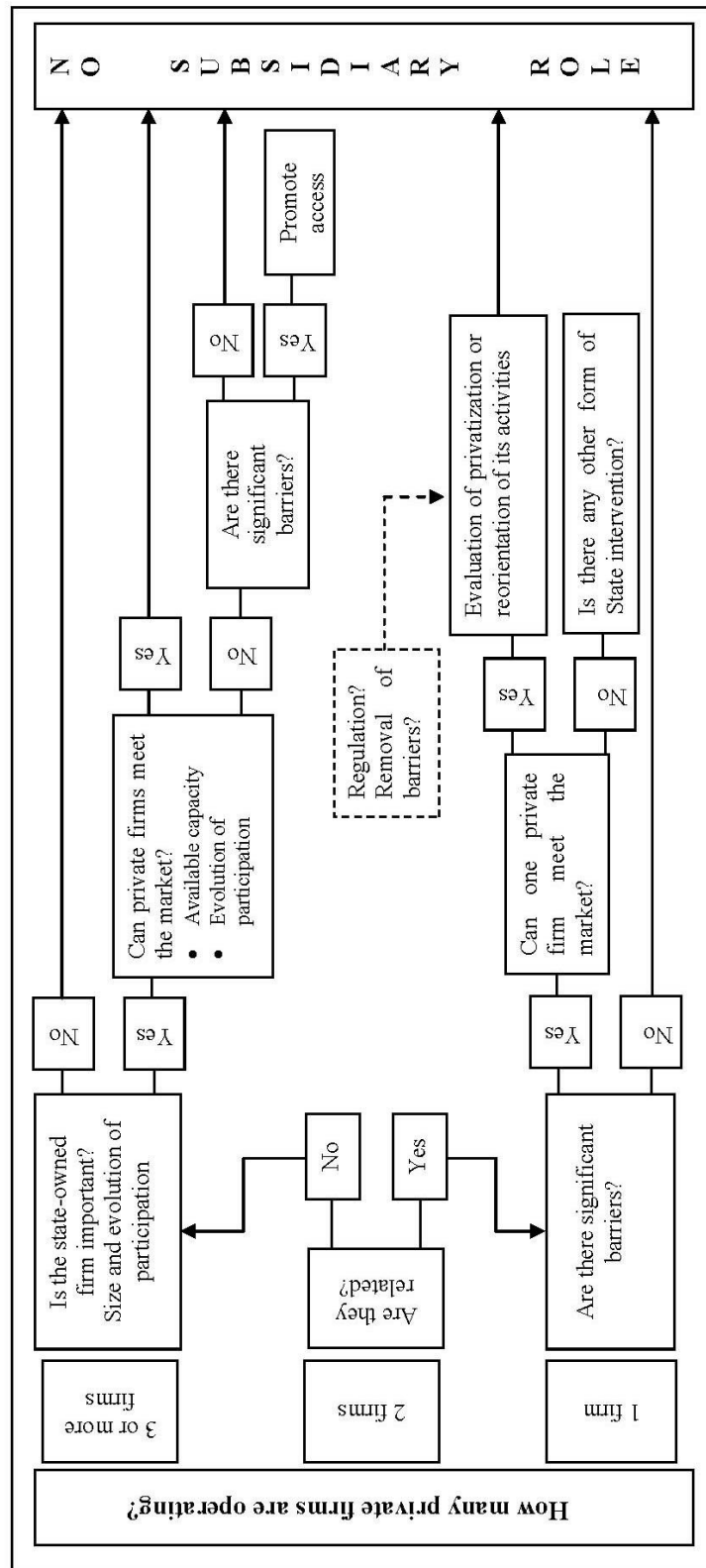

POLAND

1. Introduction

It is to be said at the outset that law on state aid in Poland is that of the European Union law. There is no Polish state aid law as such, and the way, as well as the extent to which state aid may be granted in Poland, is decided by the European Commission which is the only body in the European Union empowered to authorise granting it. It is also the case with regard to aid granted in Poland.

When it comes to granting state aid in Poland it may be delivered as:

- Aid granted under an aid scheme;
- Individual aid;
- Aid granted under block exemption regulation;¹
- *De minimis* aid.²

In general, the first two indents refer to aid which require winning the authorisation from the European Commission before it is granted. The main difference between them is that in order to obtain the European Commission's consent for an individual aid each instance of it needs to be notified to the European Commission separately, while in the case of an aid granted under an aid scheme only that scheme needs to be notified and the Commission's authorisation secured for the whole scheme. As long as the planned aid meets the conditions established in that scheme, Member States are free to decide whether to grant the aid or not. Member States do not have to notify such an aid to the Commission and it is granted under a scheme previously authorised by the Commission.

The third indent refers to aid which can be granted without notifying the aid to the Commission, as long as the aid does not exceed a ceiling set, and administrative bodies and state agencies which decide on granting that aid has the power to decide on their own whether to grant the aid sought or not. The EU rules do not determine form in which this kind of aid may be granted, so it can take any form.

The same rule applies to the *de minimis* aid which does not require any authorisation from the Commission. This aid, which should not exceed the ceiling of 200 000 Euros over any period of three years (and 100 000 Euros with regard to undertakings operating in road transport sector) is regarded as not affecting trade between Member States and not distorting or threatening to distort competition. It is possible for administrative bodies to grant that aid without bothering the Commission and seeking its authorisation. In most cases *de minimis* aid takes the form of rescheduling tax payments.

¹ Commission Regulation (EC) No 800/2008 of 6 August 2008 declaring certain categories of aid compatible with the common market in application of Articles 87 and 88 of the Treaty (General block exemption Regulation) – OJ L 214 of 9.8.2008.

² Commission Regulation (EC) No 1998/2006 of 15 December 2006 on the application of Articles 87 and 88 of the Treaty to *de minimis* aid (OJ L 379 of 28.12.2006).

2. Goals underlying granting of state aid in Poland

Any granting of state aid in Poland must take into account the underlying paradigm that it should facilitate reaching some important goals, goals whose importance exceeds the mere interests of a firm seeking the aid. So, even if firms seeking aid very often claim that they need state aid in order to protect employment level, and even if this is taken into account during the examination of the application (which is often the case), this will not help the firm to persuade the aid granting agency to grant the aid if it comes to the conclusion that such an aid will not serve the purpose it should.

Because of the above reasons, it is much easier to persuade an authority to grant an aid for firms operating in economically distressed regions. Such an aid facilitates economic and social development of these regions as well as helps people find new jobs in areas where any job is scarce. These aids benefit the whole communities and their importance exceeds the interests of firms receiving the aid.

Another goal which Poland, as also other states, wishes to obtain by granting aid is to foster innovation and development of new technologies. In order to reach that goal, local or regional authorities and agencies strive to attract new investments to their areas offering investors economic incentives in turn for those investors making new investments in their regions. In most cases incentives offered to those investors take the form of grants and tax waivers. Generally, this aid must be notified to the Commission and its consent must be secured before the aid is granted. Apart from the above requirement in order to obtain the aid sought investors must make the necessary investments, financing them with money not coming from an aid.

Protecting the environment is another goal which has been taken into consideration by Poland. As an example the scheme of state aid for bio fuels is worth mentioning. Because using bio fuels in transport instead of oil and gasoline can help reduce the carbon dioxide emissions into the atmosphere, it has great support from Polish government. However, the oil and gasoline are still much cheaper and much more available for an ordinary vehicle operator, so in order to induce car drivers to buy bio fuels their price needs to be comparable with that of oil and gasoline.

3. The use of state aid in Poland

Generally, granting of state aid in Poland is not dependent on sectors to which it is directed or whether the supported firm is a private one or government - owned (controlled). It does not matter either whether the aid seeking firm has Polish or foreign owners as long as the firm is established in Poland and pays its taxes there (otherwise Polish tax authorities would not be able to grant the aid i.e. rescheduling or waiving tax payments).

4. Aid to ailing companies, especially in the context of the financial crisis

In general, granting of aid for ailing firms can take any form but in most cases it takes the form of tax waivers, rescheduling their payment and granting of loans at below-market rates to selected firms, in which instances the aid is granted under Community guidelines on state aid for rescuing and restructuring firms in difficulty.³

In order to obtain that aid the firm seeking it diagnoses the roots of its difficulties and sets up steps necessary to recover its ability to operate efficiently on the market. In most cases such firms claim that aid is necessary to protect employment in affected regions but in general these claims are not taken for granted

³ Communication from the Commission - Community guidelines on state aid for rescuing and restructuring firms in difficulty (OJ C 244, of 1.10.2004).

without examination and in many instances, in order to recover from difficulties, firms need to make some concessions (i.e. laying off some employees). Such firms always, and this is the basic precondition imposed by the European Commission along with the requirement that restructuring process must be successful, have to make commitments concerning compensatory measures limiting the impact of that aid on competitors. This can be called “the aid price” and in many instances it takes the form of limiting the firm’s presence on the market (selling or closing a firm’s branch, imposing a cap on firm’s production volume, or limiting the amount of goods that firm is allowed to sell on the market, and so on).

Although some would say that Poland regularly engages into this kind of aid, due to the bothersome requirements imposed by the European Union legislature and the time needed to clarify all the Commission’s questions (in many instances it may take between a year or two), in fact this kind of aid has marginal significance.

These rules have not been changed in the financial crises apart from financial sector to which Poland is allowed to grant aid under two aid schemes (N 208/09 and N 302/09) authorised by the Commission. Although these schemes allow Poland to grant aid to financial institutions in the form of guarantees (N 208/09) and in the form of recapitalisation of financial institution’s assets (N 302/09), they have not been used so far by these institutions.

5. Conclusions

The rules under which aid is granted in Poland do not differ in substance from that which applies to other parts of the EU. This is because they are set at the EU level and the control mechanisms are uniform for the whole EU. The basic requirement underlying any grant of state aid is that while it should allow to reach goals which that aid aims to facilitate (economic, social and other) it must not make possible to affect trade between Member States, distort or threatening to distort competition.

The financial crises has not in substance changed these rules and even if Poland has the instruments for providing financial support for financial institutions, these programmes have not been so far used and there was not a necessity for these institutions to seek that aid from State.

ROMANIA

State aid matters are regulated at the European Union level, and such regulations are directly applicable to Romania as an EU Member State.

1. State aid concept

State aid is defined as an advantage in any form whatsoever conferred on a selective basis to “undertakings” by national public authorities. Because a company that receives government support obtains an advantage over its competitors, the Treaty of the European Communities (the “EC Treaty”) generally prohibits state aid unless it is justified by reasons of general economic development. To ensure that this prohibition is maintained and that the exemptions are applied equally across the EU, the European Commission monitors the compliance of state aid granted at the national level with EU rules.

It needs to be pointed out that the EU State Aid regulations do not apply to state aid provided to the agriculture and fishery sectors.

2. Legal restrictions on state aids

After receiving the notification, the European Commission qualifies any support measure as state aid only if it displays all of the following characteristics:

- There has been an intervention by the state or through state resources which can take a variety of forms (e.g. grants, interest and tax relief, guarantees, government holdings of all or part of a company, or the provision of goods and services on preferential terms, etc.);
- The intervention confers an advantage to the recipient on a selective basis, for example to specific companies or sectors of the industry, or to companies located in specific regions;
- Competition has been or may be distorted;
- The intervention is likely to affect trade between and among the EU Member States.

By contrast, general measures are not regarded as state aid because they are not selective and apply to all companies regardless of their size, location or sector, as, for instance, general taxation measures or employment legislation.

In accordance with EU regulations, the following types of aid are considered as compatible with the EU common market:

- Aid having a social character, granted to individual consumers, provided that such aid is granted without discrimination related to the origin of the products concerned;
- Aid in order to repair the damage caused by natural disasters.

Additionally, the following types of support may be considered compatible with the common market:

- Aid to promote the economic development of areas where the standard of living is abnormally low or where there is serious underemployment;

- Aid to promote the execution of an important project of common European interest or to remedy a serious disturbance in the economy of a Member State;
- Aid to facilitate the development of certain economic activities or of certain economic areas where such aid does not adversely affect trading conditions to an extent contrary to the common interest of the European Communities;
- Aid to promote culture and heritage conservation where such aid does not affect trading conditions and competition in the Community to an extent that is contrary to the common interest.

Generally, state aid becomes more acceptable if it aims at the increase of the innovative capacity and the development of small and medium enterprises, or is intended for the development of human capital (training, job creation etc.).

3. Specific legal provisions in Romania

Government Emergency Ordinance No. 117/2006, as approved by Law 137/2007 (“GEO 117”), is the normative act that regulates the national procedures in the field of state aid. GEO 117 provides, among other things, for the obligations of the Romanian authorities that may grant state aid and the beneficiaries of such state aid schemes, as well as the applicable sanctions in the event of a breach of these obligations.

Based on GEO 117, the power to authorise state aid plans was transferred from the Competition Council to the European Commission. The Competition Council now basically represents the national contact authority in the relations between the European Commission and public authorities and institutions that are state aid grantors, and beneficiaries involved in the state aid procedures.

Therefore, after Romania’s accession to the EU, the Competition Council became not only the national contact authority for the European Commission in this field, but it also plays the role of advisor for state aid grantors, co-ordinating the notification to the European Commission of the state aid measures that the various state-related institutions intend to grant and ensuring the elaboration of high quality state aid notifications and the fulfilment of the commitments assumed by Romania in this field as a member of the European Union.

As far as the monitoring of state aid granted in Romania is concerned, the Ordinance underlines the importance of the role played by the grantor in assuming the responsibility of obeying the rules in the area. The state aid grantors have the obligation to verify the way public money is being spent. Thus, the grantor is responsible for checking periodically if the state aid beneficiary is fulfilling the conditions assumed when receiving the state aid. If the beneficiary does not fulfil those obligations, the state aid grantor must act in order to eliminate the incompatibilities with the law in force.

On an annual basis, the grantors have to submit to the Competition Council reports on state aid granted in Romania. Also, at the Competition Council's request, the grantors have to submit any other data needed to fulfil the obligation assumed by Romania as a Member State. The state grantors are responsible for the accuracy of the data and information submitted to the Competition Council during the notification / informing or monitoring activity.

The Competition Council’s role in monitoring activity is to elaborate, based on the grantors’ reports, the state aid inventory, the annual report on the state aid granted in Romania and other necessary reports in view of fulfilling the obligations set for Romania as a EU Member State.

4. The use of state aids in Romania

Subsidies and grants, tax exemptions, tax reductions and deferrals, write-off of default interest and penalties, soft loans, state guarantees, capital injections in the undertakings are usually the most widely used forms of state intervention.

According to the latest annual inventory on state aids granted in Romania issued by the Romanian Competition Council, covering data for the period 2006-2008, the largest recipients of state aid from the view point of the state aid nature were the following sectors (excluding fishery and agriculture): transport, services of general economic interest, the coal industry, research and development as well as environmental protection, support to investments and employment; a smaller portion of public funds was directed for rescuing and restructuring industrial companies as compared to the previous periods.

As it results from the table below that compiles information excerpted from the annual inventory on the evolution of state aids according to their nature over the period 2006-2008, state aid granted in Romania has taken mainly the form of direct subsidies, grants, government holdings of all or part of a company, which represented a share of 96.6% in total state aid (excepting agriculture, fishery, transportation, services of general economic interest and de minimis aid) in 2008 in the disadvantage of tax breaks, tax reductions and deferrals, write off of default interest and penalties or state guarantees which represented only 3.4%.

Table 1. Figures in thousand Euros

	2006	2007	2008
State aid measures classified by their nature (excluding agriculture, fishery and de minimis aid)			
1. Direct Subsidies to companies (subsidies, grants, non-refundable funds)			
TOTAL	1,305,200.49	1,084,932.41	1,093,774.08
Out of which:			
a) Transport sector	560,663.52	462,366.44	513,343.43
- Railroad transport	421,998.64	312,542.98	330,595.76
- Air transport	26,818.64	26,034.58	23,494.51
b) Coal	85,942.93	112,306.36	92,029.73
c) Services of general economic interest	413,335.20	424,628.53	348,877.75
d) Research and development	22,435.78	42,840.87	64,716.59
e) Regional development	4,725.37	11,536.84	38,292.57
f) Other subsidies (granted for protecting the environment, SME-s, rescuing-restructuring, employment, media and culture, other granting objectives)	218,097.69	31,253.38	36,514.01
2. Tax breaks to selected companies or selected sectors (exemptions/allowances from paying budgetary obligations)			
TOTAL	87,204.81	28,598.89	5,142.56
Out of which:			
a) Regional development	23,879.22	8,713.61	3,585.84
- Areas for which national regional development programmes have been elaborated	3,604.62	1,827.29	1,337.83
- Deprived Areas	20,274.59	6,886.32	2,248.02
b) Rescuing-restructuring (several manufacturing sectors)	41,758.67	17,654.89	1,183.50
c) Research and development	155.71	1,766.28	0.00
d) Services of general economic interest	73.96	346.56	373.22
e) Coal	15,624.28	0.00	0.00
f) Other exemptions/allowances from paying budgetary obligations (for tourism sector, media and culture, other objectives)	5,712.97	117.54	0.00
3. Granting of government-owned inputs (such as land, bandwidth, government facilities) to companies at a price below market levels	Not granted	Not granted	Not granted
4. Government purchases at above market prices	Not granted	Not granted	Not granted
5. Granting of loans at below-market rates	Not granted	Not granted	Not granted
6. Provision of loan guarantees at below-market rates	Not granted	Not granted	Not granted

As to the objective of better targeted aid, Romania awarded 61,1% of total aid granted in 2008 for horizontal objectives of common interest such as research & development, regional aid, environmental protection, SMEs, rescue and restructuring, support to employment and training (excepting agriculture, fishery, transportation, services of general economic interest and de minimis state aid), which reveals an ascending trend of the provision of state aid for horizontal objectives (including regional aid) over the period 2006-2008. The largest proportion of horizontal aid granted in Romania in 2008 has been allocated for research and development (25.15% of total aid) followed by regional aid (16.28% of total aid).

The apparent growing trend of provision of state aid towards the development of regions can also be attributed to the national development programmes targeting the backward regions of Romania. It deserves to be mentioned that aid to promote economic development of areas where the standard of living is abnormally low or where there is serious underemployment is consistent with the article 107(3)(a) of the EC Treaty that establishes the criteria for qualifying as assisted area.

The state aid scoreboard issued by EC in the autumn of 2009 confirms that Romania followed over the last years the ascending trend of the EU vis-à-vis the provision of state aid for horizontal objectives.

With respect to the sectoral aid granted in Romania (not considering their regional destination or the nature of the state aid), the inventory shows a downward trend of their share in total state aid (excluding agriculture, fishery, transportation, services of general economic interest and de minimis aid) in 2008 (38.90%) in comparison with 2007 (46.91%). Actually, this decrease is in line with the standards set by the EC in its 2005 State Aid Action Plan. The largest proportion of the sectoral state aid was allocated both in 2008 and 2007 to the coal industry, the other sectors ceasing from benefiting from state aid. The state aid granted by the local public authorities with a view to compensate the public services of general economic interest represented the largest share in total state aid (excepting agriculture, fishery and transportation), respectively 55.71% in 2008 and 60.33% in 2007.

The latest inventory on state aid granted in Romania within 2006-2008 reveals as well that Romania allocated in 2008, 0.19% of its GDP for state aids (excluding agriculture, fishery, transportation, services of general economic interest and de minimis aid), which represents a downward trend in comparison with 2006, when Romania allocated 0.51% of its GDP for state aids.

In terms of the magnitude, the same inventory shows that the state aid provided in Romania during the period 2006-2008 has been rapidly decreasing; whereas in 2006, state aid accounted to 496,433,400 Euros, in 2008, it accounted to 257,274,060 Euros (excluding agriculture, fishery, transportation, services of general economic interest and de minimis aid).

5. The provision of government-owned or government controlled inputs

Law no. 213/1998, amended and completed, on public property and its juridical regime stipulates that public properties may be awarded only in administration to central or local public authorities, in concession or rent. It also stipulates that the renting and concession may be done only by auction, under the law provisions. Goods, activities or public services which are regulated by specific authorities may be awarded through license/authorisation only by the sector regulators to operators in order to activate on the respective markets.

For instance, radio-electric frequencies and numbering resources are scarce resources under the public property of the state. The administration and management of the radio-electric frequencies and of the numbering resources are carried out in accordance with the principles of objectivity, transparency, non-discrimination, and proportionality by ANCOM (National Authority in the electronic communications field).

According to the primary legislation in this field, i.e. EGO no. 79/2002 that regulates the basic activities related to electronic communications networks and services, in particular with respect to oversight and competition, the licenses for the use of radio-electric frequencies are granted through an open, transparent, and non-discriminatory procedure, within at most 6 weeks after receipt of a duly filled in application in this respect, accompanied by all the documents required, except for the licenses granted through a competitive or comparative selection procedure, for which the term is at most 8 months. In order to ensure that this process does not drive to restricting, hindering or distorting competition, the legislation stipulates that the right of use is awarded to the winner of a tender, following the offer of the largest amount for the license fee, while ensuring compliance with certain short listing technical, administrative and/or financial criteria.

In general, Romanian authorities address the Romanian Competition Council when they have doubts that the allocation of public goods and/or the award of public services would entail state aid. As per the community legislation and practice in this field, the Romanian Competition Council in its capacity of state aid advisor explains Romanian authorities involved the terms under which such procurement transactions may qualify as state aid and the legal options of making such operations compatible with community state aid rules.

In principle, when procurement transactions are conducted following the observance of an open, transparent and non-discriminatory procedure or an expert evaluation, the level of market sector support can be regarded as representing the market price corresponding to the respective procurement transactions and consequently, it is presumed that no state aid is involved.

6. Aid to ailing companies, especially in the context of the financial crisis

Under the framework of the current economic and financial crisis, the Member States of the EU can grant state aids either in the context of the existing rules and regulations or by enforcing the temporary steps that the EC has put into place to address the current situation in the real economy and the financial sector.

Accordingly, aid to ailing companies can only be authorised as temporary rescue aid or as restructuring aid in the context of a restructuring plan. Both types of aid are subject to strict conditions. For example, rescue aid can only be granted in the form of a guarantee or loan for the time needed to develop a restructuring plan. It has to be reimbursed if no plan is presented within six months. Conditions for authorising restructuring aid are, for example, the presentation of a credible plan allowing the company to become viable again, respect of the one time last time principle, counterparts offered by the company in terms of capacity reductions etc.

In the financial sector, the European Commission approved under current exceptional circumstances the aid plans to bail out the banks through capitalisation, state guarantees, rescue and restructuring packages and other measures put in place by several Member States, but for Romania who did not face any difficulties in the banking sector (see State Aid Scoreboard, Autumn 2009 Update, Brussels, COM (2009)).

As per the norms provided by the EC's temporary framework for state aid measures and the conditions regarding the compatible limited amount of aid for the real economy, the following state aid measures have been proposed and implemented by Romanian authorities following EC approval, with a view to counter negative effects of the global financial-economic crisis over the Romanian economy:

6.1 State aid scheme in the form of state guarantees granted to SMEs and large enterprises elaborated by EximBank enabling access to loans in the period of economic and financial crisis

By implementing the scheme, the Romanian authorities expect to help SMEs counter the crisis, relieve their access to credits and ensure the continuity in their activity.

The scheme targets Romanian legal persons who were not in difficulty on 01.07.2008, but who entered into financial difficulty at the moment of the guarantee request, as a result of the present world economic – financial events. The beneficiaries can activate in all activity sectors, but for the production of armament, gambling, production of alcohol and tobacco, real estate transactions and acquisition of means of transport for persons with a capacity of up to 8 persons. The estimated number of beneficiaries within the scheme is of 180.

Through this scheme, EximBank guarantees on the name and on behalf of the Romanian State, maximum 90% from the value of a new credit granted by a commercial bank for investments and/or working capital.

The applicants may benefit from a reduction of the guarantee bonus for a maximum period of 2 years from the date when the guarantee was granted. A 25 % reduction is applicable to the SMEs while a 15% reduction is applicable to the large enterprises.

The maximum value of the credit subject to the guarantee shall not exceed the company's total costs with wages in 2008.

The lifetime of the state aid scheme is 2 years, namely 2009–2010. The guarantees fund amounts to 450 million RON for the two years. The total budget of the scheme for the implementing period is 20.34 million RON, out of which 11.30 million RON are allocated for 2009.

6.2 The temporary national state aid scheme supporting Romanian enterprises affected by the present financial and economic crisis (maximum 500.000 Euros)

In full compliance with the norms provided by EC's Temporary framework for state aid measures and the conditions regarding the compatible limited amount of aid, Romania elaborated a supporting scheme to grant, without notification of individual cases, subsidised loans, loan guarantees at a reduced premium, risk capital for SMEs and direct aids of up to 500,000 Euros. These aids are allowed until the end of 2010 and may be granted to firms which were not in difficulty on 1st of July 2008, but entered into difficulty thereafter. The estimated number of beneficiaries within the scheme is above 1000 and the total budget of the scheme for the implementing period is of approximately 220 million Euros.

This state aid scheme is supposed to contribute to alleviating the difficulties faced by Romanian companies without a significant distortion of the market.

6.3 State Aid for Ford Romania (Car Industry)

The financial aid consists in an 80% state guarantee provided by Romania to enable Ford Romania SA to access a 400 million Euros loan from the European Investment Bank. The aid supports the investment project envisaged by Ford at Craiova plant for the period 2008-2012.

The development project of Ford at the Craiova plant is part of a joint European venture to develop low CO2 emission engines and cars, assuming total costs of approximately 1.69 billion Euros over a 5-year period.

The entire project requires investments not only in Romania but also in Germany where low CO₂ emission engines and cars are planned to be developed.

The European Investment Bank lends a total of 600 million Euros to Ford Europe for the development project, out of which 200 million Euros goes to Ford Werke GmbH in Germany and 400 million Euros to Ford Romania.

The 80% guarantee to be provided by Romania was considered by the EC as compatible with Article 107(3)(b) of the EC Treaty, which permits aid to remedy a serious disturbance in the economy of a Member State. In particular, Ford Romania would pay a premium for the guarantee and provide sufficient securities in case the guarantee would be drawn.

Apart from these measures, in 2009, in Romania, other state aid schemes have been elaborated in compliance with the existing community rules on state aid. The total budget of these schemes amounts to 6 billion Euros and represent national and community funds. It is estimated that more than 60,000 enterprises would benefit from these schemes in the following years depending on the implementation period. The larger part of the state aid measures envisages regional development aiming at creating and maintaining jobs as well as professional training.

7. Advocacy institutional mechanisms

The awareness of state aid in Romania is gradually increasing, thanks to the intense competition advocacy activities (publication of various guides, monthly bulletins, case law and legislative syntheses, other informational materials and organisation of seminars, roundtables and conferences throughout the country) performed by the Romanian Competition Council not only before accession to the EU but also thereafter. In this way, the authorities, other state aid grantors and the beneficiaries got acquainted to the requirements that need to be satisfied for the state aid to be compatible with EC regulations.

Also, a very important role in raising awareness on state aid rules among all the stakeholders involved after Romania's accession to the EU was played by the pre-consultation mechanism with the EC experts in the privatisation field set up at the Romanian Competition Council's request in June 2008. Within this mechanism, more than 50 information sheets on companies intended to be privatised by the Authority for State Assets Recovery (hereinafter AVAS) have been transmitted to the EC. Actually, the technical consultations that took place with the EC under the umbrella of the pre-consultation mechanism initiated in the privatisation process aimed at preventing the existence of any incompatible state aid elements within the privatisation processes.

As a result of the setting up of the pre-consultation mechanism in the privatisation field, the Romanian authorities have ordered adequate measures aimed at ensuring compliance with state aid community rules, such as: the amendment of the privatisation legislation in the mining and R&D sectors, respectively the elimination of the certain tender conditions attached to the privatisation process that created premises for state sales at a price below market level and consequently to doubts that the privatisation process entailed state aid, the cancellation of privatisation procedures for certain companies acting in these sectors, as well as the revision of the privatisation strategies of certain companies, aiming to ensure that the tender itself as a method of privatisation was open, transparent and non-discriminatory so that the potential investors would not have been disadvantaged at an early stage and deterred from submitting a bid.

The role of adviser to all state aid grantors in drawing up of notifications, information sheets and in monitoring activities, or in the allegation of the notification before the EC safeguarded by Romanian Competition Council also after Romania's accession to EU complemented by the advocacy power of Romanian Competition Council to issue binding advisory opinions on draft normative acts that may have

an anticompetitive impact and to propose amendments definitely increased the profile of the Romanian competition authority among all stakeholders involved in Romania.

Moreover, the Romanian Competition Council performs its activities in a transparent manner. As a proof, driven by the desire to improve the informal co-operation between the parties involved in the state aid field, the Romanian Competition Council put the foundation in the second part of 2008 of the Romanian State Aid Network, a portal created on a multi-annual base which aims at creating a cluster of state aid experts from the Romanian Competition Council and from the state aid granting institutions in order to strengthen their cooperation and a swifter implementation of the support measures, be it state aid or not, in compliance with the community provisions in the field, having as a final objective the support of the business environment and of the Romanian economy in general.

At the same time, through this portal, Romanian Competition Council ensures nowadays a smooth access to all the relevant information in the state aid field, so that the beneficiaries, the practitioners and the theoreticians have the necessary instruments to be informed on the trends in the state aid field both at national and at the community level. Finally, thanks to Romanian Competition Council's initiative, all the interested parties are now able to find on the website of the Network (<http://www.ajutordestat.ro/?pag=146>), the state aid schemes implemented in Romania, the applicable legislation and articles on state aid, projects to be performed within the Network, etc.

RUSSIA

In order to ensure pro-competitive, transparent and efficient mechanism of state aid granting and control of its use, a special Chapter 5 devoted to the Provision of state or municipal aid was incorporated in the competition legislation with the adoption of the Federal Law no. 135-FZ of 26.07.2006 “On Protection of Competition”. This Law defined for the first time the term “state aid” as provision by the state authorities of advantages ensuring to some economic entities more favourable conditions of activity in the relevant market in comparison with the other market participants by means of disposal of property and (or) other objects of civil rights, the right of priority access to information. In general, granting of state or municipal aid is prohibited because as a matter of fact government interventions distort competition. However there is left a room for a number of policy objectives for which state aid can be considered compatible. The Law provides for a number of such objectives that are typically socially and culturally oriented. The Law also contains a detailed procedure of state or municipal aid granting with a number of measures taken in case of misuse of this aid or revealed violation during granting of this aid.

Earlier, granting of state or municipal aid was controlled by the Russian antimonopoly authority within the frameworks of control over state authorities provided for in the Federal Law no.948-1 of 22.03.1991 “On competition and restriction of monopolistic activity on commodity markets”. It prohibited provision of privileges to the specific economic entity or several economic entities that provides them with preferred position in relation to the positions of other economic entities operating on the same commodity market.

The FAS Russia established a special Department on Control over State Authorities to ensure smooth and efficient application of the relevant provisions of control and monitor of the state aid granting.

In October 2009 the Federal Law 164-FZ of 17.07.2009 “On introducing of Amendments to the Federal Law on Protection of Competition and Some Legislative Acts of the Russian Federation” introduced some changes to the state aid provisions. The term “state or municipal aid” was replaced by the term “state or municipal preferences” in order to ensure that provision of property advantages is considered as granting of state or municipal preferences (for example: tax, property or rent relief). State or municipal preference is defined as the provision by a state or municipal body or by a body or organisation exercising their functions of advantages to specific economic entities which provides them with better conditions for their activity by means of the transfer of state or municipal property or objects of civil-law rights or by means of the provision of privileges having a property or monetary value. This definition is broader and better complies with the standards of the European competition legislation compared to the definition of “state aid” given before. Moreover, with the purpose of competition advocacy the word “preference” has a more negative perception than “aid”.

Amendments to the regulation of the procedure of granting of state or municipal preference are aimed at ensuring that there will be no optional enforcement with this regard that may lead to corruption.

The provision of preference requires the prior consent of the FAS Russia on the basis of a written notification submitted by the state authorities intending to grant state or municipal preference. Preference may not be provided for purposes that are not consistent with those stated in the notification for consent. Prior consent is not required for preferences that are provided on the basis of federal, regional or local laws

on the budget that define (or specify a procedure for defining) the amount of the preference and those to whom it is to be provided.

Numbers of matters addressed under certain Articles of the Law regulating provision of state preferences have been growing steadily since 2007. In 2007, the FAS Russia reviewed 33 notifications on state aid, opened a total of 149 formal cases concerning possible violations (most of these on its own initiative), found a total of 66 violations and issued 59 orders for correction. In 2008, these numbers more than doubled to a total of 89 notifications and a total of 343 formal cases opened, with violations found in 192 instances and 131 orders issued. For 2009 the numbers appear on track to double again, with 178 notifications, 236 formal cases, 171 violations and 142 orders reported for the first half of the year.

As a result of financial downturn a number of sectors of economy faced considerable challenges. Governments worldwide elaborated special national support programmes, including state aid granting to recover the mostly damaged sectors. The role of the competition authorities here is to ensure that this support is provided with the less negative effect on competition.

In particular, in the first half of 2009 the production in the car industry in Russia decreased for about 60%, sales – for 51% in comparison with January-July 2008. Liquidity shortage, huge debts, temporary stopping of production lines, necessity to reduce the number of employees and a reduction in the demand were the reasons to take certain steps to rescue the sector. These conditions were the reasons for the Government of the Russian Federation to undertake certain actions to rescue this sector (i.e. state preference programmes, concessional lending programme).

In order to ensure that state preferences are not granted to one certain company and it does not harm competition in the automobile industry, the FAS Russia succeeded in securing pro-competitive principles that would lead to industry stabilisation. The FAS Russia contributed to extending the list of criteria that allow referring certain cars to the state preferences programmes. As a result, the foreign companies that enter the Russian car industry and build their plants on the Russian territory are also able to participate in the state preferences programme.

Besides, the FAS Russia contributed to the considerable extension of the list of cars for concessional lending programme, including increase of the maximum price for cars that can be included into the list.

So, there was ensured a level-playing field for all market players that is likely to lead to stabilisation of situation in the car industry and to exert positive influence on the development of national and foreign producers of vehicles.

SENEGALESE NATIONAL COMPETITION COMMISSION

Freedom of competition or free competition between enterprises supplying products or services tending to meet identical or similar needs in a given market must be guaranteed by the State in which public power is invested.

The State, however, has a variety of missions, one of which is to ensure the economic and social well-being of its population through the various policies which, in principle, it is free to choose.

Accordingly, in its role in allocating and redistributing resources, the State may well find itself providing different types of aid to economic actors.

These State aids or aid from State resources may take a number of forms: soft loans, tax breaks, exemptions, etc. They may consist in a subsidy, which should be treated as the financial contribution or “sum paid by the public authority to an economic unit or group of units (region, branch, sector, etc.) for a social or economic purpose”.

In themselves, these State aids may not be a bad thing and may be justified by a positive economic balance. They may even appear to be the best or sole choice possible or may even be a “necessary evil”, as demonstrated by the massive intervention by governments during the recent international financial crisis to keep their banks afloat or to relaunch the economy.

However, these State aids or subsidies may also have a downside, namely distortion of the free play of competition through the preference of “an enterprise, sector of production of goods or service” over its competitors. They may also be seen as unfair, discriminatory measures that are equally damaging to both the national economy and to the regional, community or international trade it is accused of impeding.

For all the above reasons, we feel that, provided that account is taken of the interests of developing countries, and particularly the LDCs, State aids and other State subsidies should be subject to competition law.

Moreover, such regulations already exist in regional economic union. The World Trade Organisation, for its part, prohibits specific subsidies.

In the case of West African States, these regulations are taken into account in the community legislation on competition of the West African Economic and Monetary Union (UEMOA-WAEMU) and the Economic Community of West African States (CDEAO or ECOWAS) composed of sixteen States, eight of which are members of WAEMU.

In the following paragraphs we shall briefly discuss State aids or subsidies in the UEMOA – CDEAO area (1), some of the issues that certain subsidies raise in the WTO (2) and, despite everything, in conclusion the need to regulate State aids and subsidies while taking account of the particular situation of LDCs (3).

1. Practices regarding state aids and subsidies and the account taken of such aid in community competition law of the WAEMU and ECOWAS

1.1 Practices regarding State aids and subsidies

All States make use, depending upon their circumstances, of subsidies and State aids.

West African countries are no exception to this rule. They intervene in the economy to help certain enterprises in a variety of way, in particular through tax exemptions to attract investors and in the event of increases in global commodity prices (flour, rice, etc.).

Without wishing to restrict the discussion to Senegal, Article 18 of Act number 2204-06 of the Senegalese investment code offers a good example of such aid. It provides for an exemption from the lump-sum employer's contribution for up to 5 to 10 years. Special facilities are also granted with regard to corporation taxes.

In reality, the idea uppermost in the minds of the various national economic operators in our young States is that national enterprises need to be protected from foreign competition and also require government support in the form of subsidies (formerly customs duties that gave national enterprises an advantage over imports in one major West African country).

Criticism was thus levelled within WAEMU against the tax exemptions some States granted their hauliers for "truck purchases" and the "credit lines" they allegedly extended to them, which had an adverse impact on competition. Such exemptions apparently exist in the telecommunications sector for new operators entering the market.

At the strictly national level, two complaints against States deserve mention.

- The first is that brought by a private press group which owns a radio station and a television station and which accuses the State of awarding exclusive television broadcasting rights, bought out of public funds, to matches from the 25th African Cup of Nations (Ghana 2008) to the sole publicly owned broadcasting channel.
- The second relates to a guarantee of over a billion francs which the State apparently gave to a peanut marketing company, to the detriment of its competitor.

This case has been referred to the WAEMU Commission. As we shall see, both WAEMU and ECOWAS have issued regulations regarding State aids and subsidies.

1.2 Account taken of State aids and subsidies in WAEMU and ECOWAS community competition law

As in other regions of the world, national legislation makes no provision for State aids, even though the national Commission has been asked to give an opinion on an application for a subsidy addressed to the Senegalese government¹. This vacuum has been filled by community regulations on competition, such as those drawn up by WAEMU and ECOWAS.

¹ In its opinion No. 05-A-08 of 27 November 2008, the national competition commission of Senegal recalled that the State is obliged to respect the equality of treatment of enterprises that find themselves in similar circumstances and that if it wishes to accede to the application that has been made the State must first notify "the WAEMU Commission of the planned award of aid".

Article 8 of Additional Act A/SA-1/12/08 regarding the adoption of community regulations on competition and procedures for their application within ECOWAS has the same content as Article 2-1 of Regulation No. 04/2002/CM/UEMOA regarding State aids within WAEMU and the procedures for applying Article 88 (c) of the Treaty.

These two pieces of legislation enshrine the principle of the incompatibility of public aids (WAEMU text) or aids granted by States or provided from State resources (ECOWAS text) when such aids are liable to distort competition by favouring certain enterprises or types of production.

However, they also consider the case (Article 3 of the WAEMU regulation, Article 8 of the ECOWAS Additional Act) of public aids which would be compatible with the WAEMU or ECOWAS Common Markets (e.g. aids designed to promote a major project of interest to the community or to remedy serious disruption in the economy of a Member State).

Nonetheless, the ECOWAS Additional Act does not appear to be as comprehensive as the ECOWAS regulation with regard to aid.

By way of example, there is no provision in the ECOWAS Additional Act comparable to that made by the WAEMU, based on the subsidies banned by the WTO, whereby public aid in the form of subsidies that are “conditional ... on the export performance to other Member States ... or on the use of domestic products in preference to products imported from other Member States” (Article 4 of WAEMU Regulation 4) is banned *ipso jure* with no possibility of repayment.

The sanctions for offences are specified more clearly in the WAEMU legislation, which provides for the suspension or recovery of illegally awarded aid, than in ECOWAS legislation. .

Article 10 of the ECOWAS text on measures by the Authority² with regard to public aids and anticompetitive practices attributable to public enterprises states simply that: “any person or Member State who has suffered losses due to a prohibited anticompetitive practice in accordance with the provisions of the Additional Act regarding the adoption of community rules on competition pay subject a request for compensation to the Authority and the Authority may, if it is convinced that, in the event, it is justified by the facts, order the offender or offenders to pay compensation to the plaintiff.”

This sanction may seem woefully inadequate and doubtless ECOWAS community legislation on competition will have to be supplemented and improved in order to, at the very least, ease the difficulties that State aids and subsidies cause or will inevitably cause. This is the purpose of the following paragraph in which a number of issues relating to the WTO will also be discussed.

2. The issue of subsidies in WAEMU and ECOWAS legislation and in the WTO

2.1 *The problem with the implementation of State aids and subsidies within the framework of the WAEMU and ECOWAS*

Article 5.2 of Directive 02/2002/CM/UEMOA regarding co-operation between the WAEMU Commission and national competition structures recalls that the WAEMU Commission has sole competence to know about State aids.

ECOWAS considers that this competence is the prerogative of the “Competition authority directed by an Executive Director assisted by two Deputies and the staff the authority needs to function” (Article 2 of

² This is the ECOWAS Competition Authority.

Additional Act A/SA.2/12/08 on the creation, powers and functioning of the ECOWAS Regional Competition Authority.

The issue of the uniformity of the definitions and prohibitions set out in the two sets of legislation should be avoided.

The existence of two competition authorities could give rise to disputes over jurisdiction between the two bodies or problems relating to the perception or conception that each body might have of the role and relations to maintain with national competition authorities or structures.

At present, unlike the current situation in the European Union, there is very little disagreement over State aids, despite the fact that, as noted earlier, such aids do exist.

In fact, the ECOWAS Commission has already had experience of such disagreements. By way of example, in a case in which “Soccocim Industries” complained of distortion in the operation of the cement market due to a difference in treatment by the State in favour of “Ciments du Sahel”, which benefited from tax and customs advantages under a mining agreement, the ECOWAS Commission asked the Senegalese government to cease granting exemptions for clinker imports and stated that “since any failure to comply with this ban amounts to the granting of public aid, it would be examined in accordance with Regulation No. 04/2002/CM/UEMOA of 23 May 2003 on public aids (Decision No. 003/2005/COM/UEMOA).

In another case known as the “RUFSA” affair, the ECOWAS Commission apparently held that exemptions granted to cement manufacturers important paper packaging was responsible for distorting competition at the expense of locally manufactured packaging.

However, in our opinion, the main issue should be the efficiency of sanctions imposed on States and the will of the latter to comply with such sanctions.

The regulation of subsidies and application of legislation governing subsidies also raises issues in the WTO.

2.2 *The issue of subsidies in the WTO*

Manufacturing subsidies, which are tolerated by the WTO, and export subsidies, which are banned by that organisation, both have an impact on competition.

As everyone knows, export subsidies, which countries are committed to reduce in the agricultural sectors, seriously damage the interests of poor countries and are responsible for them losing substantial amounts of export earnings.

It has already been argued that European subsidies combined with direct aids allow European countries to practice dumping in world markets.

Even now, the losses observed in cotton production in certain African countries are apparently due to cotton support policies in the United States.

And yet nothing appears to be able to stop State aids or subsidies. Direct or indirect aids are given to car manufacturers. A few months ago the European Union apparently announced new export subsidies for butter, cheese and powdered milk.

Apparently, WTO regulations and the way in which they are applied are not sufficient to settle all the issues regarding State aids and subsidies. Admittedly a body does exist to settle disputes which can secure the withdrawal of a subsidy or eliminate the adverse effects of a subsidy. However, it is also known that

the cost to poor countries of initiating that organisation's procedures is prohibitively high, not to mention the ambiguity and difficulty in interpreting its regulations and, according to some commentators, the inconsistency of the latter.

3. Conclusion

These observations do not cast doubt on the usefulness of the WTO, which has in the past ruled against developed countries. What needs to be recognised is that the issue of State aids and subsidies is a complex one. Regardless of whether or not such aids are justified from an economic standpoint, they can always be justified by all countries in terms of policy. Given that they can distort competition and disrupt world trade, they need to be regulated in order to avoid the antagonism and fierce rivalries of the past. World peace demands this. In our opinion, the issue of State aids and subsidies can only be resolved within the framework of the new world governance made necessary and desirable by the international financial crisis.

This new world governance, within whose framework different competition policies will be co-ordinated, will combine a series of economic, legal and other rules in which ethics, equity and justice will play a major role. Above all, this new governance of State aids and subsidies in a more global framework of world governance must necessarily take account of the imperatives of development and the situation of permanent crisis in which certain developing countries and LDCs currently find themselves.

COMMISSION NATIONALE DE LA CONCURRENCE DU SÉNÉGAL

La liberté de la concurrence ou la libre compétition des entreprises qui offrent, sur un marché déterminé, des produits ou services tendant à satisfaire des besoins identiques ou similaires, doit être garantie par l'État, détenteur de la puissance publique.

Or, l'État a différentes missions parmi lesquelles celle d'assurer le bien-être économique et social de ses populations au travers de diverses politiques dont, en principe, il a le libre choix.

Ainsi, dans son rôle d'allocation ou de redistribution des ressources, il peut advenir qu'il fournisse différentes aides à des acteurs économiques.

Ces aides d'État ou aides accordées au moyen de ressources d'État peuvent revêtir plusieurs formes : prêts à taux préférentiel, allègements fiscaux, exonérations diverses... Elles peuvent consister en une subvention, celle-ci devant être considérée comme la contribution financière ou « la somme versée par la puissance publique à une unité économique ou à un groupement d'unités (région, branche, secteur, etc.) dans un but social ou économique ».

En soi, ces aides d'État peuvent ne pas être mauvaises et être justifiées par un bilan économique positif. Elles peuvent même apparaître comme le meilleur ou le seul choix possible ou même constituer un « mal nécessaire ». La récente crise financière internationale l'a démontré avec l'intervention massive des États pour renflouer les banques ou relancer l'économie.

Mais ces aides ou subventions peuvent aussi avoir leur travers, celui de fausser le libre jeu de la concurrence dans la mesure où elles viennent favoriser « une entreprise, un secteur de production de biens ou de services » au détriment de leurs concurrents. Elles peuvent ainsi apparaître comme des mesures injustes, discriminatoires et nuiraient aussi bien à l'économie nationale qu'au commerce régional, communautaire ou international qu'elles entraveraient.

Pour toutes ces raisons, nous pensons que, sous réserve de tenir compte des intérêts des pays en développement, surtout des PMA, les aides d'État et autres subventions publiques devraient être encadrées par le droit de la concurrence.

Du reste, cette réglementation existe dans le cadre d'unions régionales économiques. De son côté, l'organisation mondiale proscrit les subventions spécifiques.

En ce qui concerne les États de l'Afrique de l'Ouest, cette réglementation est prise en compte par la législation communautaire sur la concurrence de l'Union Economique et Monétaire Ouest Afrique (UEMOA-WAEMU) et par celle de la communauté des États de l'Afrique de l'Ouest (CDEAO ou ECOWAS) composée de seize États dont huit sont membres de l'UEMOA.

Dans les paragraphes suivants, nous traiterons brièvement des aides d'État et subventions dans la zone UEMOA – CDEAO (1), de quelques questions que peuvent poser certaines subventions au sein de l'OMC (2) et, malgré tout, en conclusion, de la nécessité de la régulation des aides et subventions d'État en tenant compte de la situation particulière des PMA (3).

1. La pratique des aides d'État et subventions et leur prise en compte par les droits communautaires sur la concurrence de l'UEMOA et de la CDEAO

1.1 La pratique des aides d'État et subventions

Tous les États recourent, selon les circonstances, aux subventions et aides d'État.

Les pays de l'Afrique de l'Ouest n'échappent pas à la règle. Ils interviennent sur l'économie au profit de certaines entreprises par divers moyens, notamment par des exonérations fiscales pour attirer les investisseurs et lors des hausses des cours du marché mondial (farine, riz, etc.).

Sans que cela soit spécifique au Sénégal, l'article 19 de la loi numéro 2004-06 de son code des investissements peut être cité en exemple. Il prévoit une exonération de la contribution forfaitaire à la charge des employeurs pouvant aller de 5 à 10 ans. Des avantages particuliers sur l'impôt sur les bénéfices sont aussi accordés.

En réalité, l'idée dominante partagée par les divers opérateurs économiques nationaux de nos jeunes États est que les entreprises nationales ont besoin d'être protégées de la concurrence étrangère et de l'appui des États par le biais des subventions (ex-taxation douanière avantageant les entreprises nationales face aux importations dans un grand pays de l'Afrique de l'Ouest).

Ainsi, est-il aussi déploré, au sein de l'UEMOA, des exonérations fiscales que certains États feraient en faveur de leurs transporteurs pour « l'achat de camion » et « les lignes de crédits qu'ils leur apporteraient » au détriment de la concurrence dans l'Union. De telles exonérations existeraient dans le secteur des télécommunications en faveur de nouveaux opérateurs entrant dans ce marché.

Au plan strictement national, deux griefs faits à l'État peuvent être signalés.

- Le premier est celui d'un groupe de presse privé disposant d'une radio et d'une télévision qui lui reproche d'avoir concédé, à la seule chaîne publique, les droits de diffusion et de télévision, obtenus sur des ressources publiques, des matchs de la 25^{ème} édition de la Coupe africaine des nations (Ghana 2008).
- Le second tient à la garantie de plus d'un milliard de francs qu'il aurait donnée à une société de commercialisation de l'arachide aux dépens de sa concurrente.

La commission de l'UEMOA a été saisie de cette affaire. En effet, comme on va le voir, l'UEMOA comme la CDEAO ont réglementé les subventions et aides d'État.

1.2 La prise en compte des aides d'État et subventions par les droits communautaires de la concurrence de l'UEMOA et de la CDEAO

Comme dans d'autres régions du monde, les législations nationales ne prévoient aucune disposition sur les aides d'État même si la Commission nationale a eu à donner un avis sur une demande de subvention adressée à l'État du Sénégal¹. Ce vide est comblé par les dispositions communautaires sur la concurrence, celles de l'UEMOA comme celles de la CDEAO.

¹ Dans son avis n° 05-A-08 du 27 novembre 2008, la commission nationale de la concurrence du Sénégal a rappelé que l'État a l'obligation de respecter l'égalité de traitement entre entreprises se trouvant dans des conditions similaires et que s'il veut satisfaire à la demande qui lui est faite, l'État doit, au préalable, notifier « le projet d'octroi d'aide à la Commission de l'UEMOA. »

L'article 8 de l'Acte Additionnel A/SA-1/12/08 portant adoption des règles communautaires de la concurrence et de leurs modalités d'application au sein de la CDEAO est de la même teneur que l'article 2-1 du Règlement n° 04/2002/CM/UEMOA relatif aux aides d'État à l'intérieur de l'UEMOA et aux modalités d'application de l'article 88 (c) du Traité.

Ces deux textes posent le principe de l'incompatibilité des aides publiques (texte de l'UEMOA) ou des aides accordées par les États ou au moyen de ressources d'État (texte de la CDEAO) lorsqu'elles sont susceptibles de fausser la concurrence en favorisant certaines entreprises ou certaines productions.

Mais ils envisagent aussi (article 3 du règlement de l'UEMOA, article 8 de l'Acte Additionnel de la CDEAO) les aides publiques qui seraient compatibles avec le Marché Commun de l'UEMOA ou avec le marché commun de la CDEAO (ex. aides destinées à promouvoir la réalisation d'un projet important d'intérêt communautaire ou à remédier à une perturbation grave de l'économie d'un État membre).

Cependant, l'Acte Additionnel de la CDEAO ne semble pas aussi complet que le Règlement de l'UEMOA sur les aides.

A titre d'exemple, ne figure pas dans l'Acte Additionnel de la CDEAO, cette disposition de l'UEMOA, inspirée des subventions prohibées de l'OMC, selon laquelle : sont interdites de plein droit, sans aucune faculté de rachat, les aides publiques sous formes de subventions « subordonnées...aux résultats à l'exportation vers les autres États Membres...ou à l'utilisation de produits nationaux de préférence à des produits importés des autres États Membres » (article 4 du Règlement n° 04 de l'UEMOA).

Les sanctions prévues sont mieux définies dans la législation UEMOA, qui prévoit jusqu'à la suspension ou la récupération de l'aide illégalement octroyée, que dans celle de la CDEAO.

L'article 10 du texte de la CDEAO sur les mesures de l'Autorité² relatives aux aides publiques et aux pratiques anticoncurrentielles imputables aux entreprises publiques dispose seulement : « toute personne ou État Membre ayant subi des pertes en raison d'une pratique anticoncurrentielle prohibée en application de l'Acte Additionnel portant adoption des règles communautaires de la concurrence, peut introduire une demande d'indemnisation auprès de l'Autorité, et l'Autorité peut, si elle est convaincue qu'en l'occurrence, les faits le justifient, ordonner au contrevenant ou aux contrevenants de verser une indemnité au demandeur ».

Cette sanction paraît bien insuffisante et certainement la législation communautaire sur la Concurrence de la CDEAO devra être complétée et améliorée pour, au moins, amoindrir les difficultés que posent ou ne manqueront pas de poser les aides d'État et subventions. C'est l'objet du paragraphe suivant où seront également abordées certaines questions relatives à l'OMC.

2. Le problème des subventions dans les législations de l'UEMOA et de la CDEAO et au sein de l'OMC

2.1 *Le problème de la mise en œuvre des aides d'État et subventions dans le cadre de l'UEMOA et de la CDEAO*

L'article 5.2 de la Directive n° 02/2002/CM/UEMOA relative à la coopération entre la Commission de l'UEMOA et les structures nationales de concurrence rappelle que la Commission de l'UEMOA a compétence exclusive pour connaître des aides d'État.

² Il s'agit de l'Autorité de la Concurrence de la CDEAO.

Pour la CDEAO, cette compétence est dévolue à « l'Autorité de la concurrence dirigée par un Directeur Exécutif assisté de deux Adjointes et du personnel nécessaire à son bon fonctionnement » (art. 2 de l'Acte Additionnel A/SA.2/12/08 portant création, attributions et fonctionnement de l'Autorité Régionale de la concurrence de la CDEAO).

Le problème de l'homogénéité des définitions et interdictions des deux législations communautaires devrait être évité.

L'existence de deux autorités de la concurrence pourrait être à l'origine de conflits de compétence entre les deux instances ou de difficultés liées à la perception ou à la conception que chacune d'elle aurait du rôle et des relations à entretenir avec les autorités ou structures nationales de la concurrence.

Aujourd'hui, à l'inverse de ce qui passe dans l'Union européenne, le contentieux sur les aides d'État est faible. Pourtant, ces aides existent ainsi qu'il a été dit plus haut.

De fait, la Commission de l'UEMOA en a déjà connu. A titre d'exemple, dans une affaire où la « Sococim Industries » se plaignait de distorsions dans le fonctionnement du marché du ciment en raison d'une différence de traitement de l'État en faveur des « Ciments du Sahel », bénéficiaire d'avantages fiscaux et douaniers en vertu d'une convention minière, la Commission de l'UEMOA a invité l'État du Sénégal à cesser d'accorder des exonérations sur les importations de clinker et a dit que « tout manquement à cette interdiction étant constitutif d'octroi d'aides publiques, sera examiné en application des dispositions du Règlement n° 04/2002/CM/UEMOA du 23 mai 2003 sur les aides publiques (Décision n° 003/2005/COM/UEMOA).

Dans une autre affaire dite « RUFSAK », la Commission de l'UEMOA aurait considéré que les exonérations accordées à des cimenteries importatrices d'emballages en papier seraient à l'origine de distorsions de concurrence au détriment des emballages fabriqués localement.

Mais, à notre avis, le grand problème devrait porter sur l'efficacité des sanctions prononcées contre les États et la volonté de ceux-ci de les respecter.

La réglementation des subventions et l'application des textes qui les régissent suscitent aussi des questions au sein de l'OMC.

2.2 *Le problème des subventions au sein de l'OMC*

Les subventions à la production, tolérées par l'OMC, et les subventions à l'exportation, prohibées par l'organisme mondial, ont des incidences sur la concurrence.

Comme tout le monde le sait, les subventions à l'exportation, qui font l'objet d'engagements de réduction en matière agricole, nuisent gravement aux intérêts des pays pauvres et leur occasionnent des pertes considérables en termes de recettes d'exportation.

Il a été déjà soutenu que les subventions européennes conjuguées aux aides directes permettent de faire du dumping sur les marchés mondiaux.

Aujourd'hui encore, les déficits notés dans la production du coton dans certains pays africains s'expliqueraient par les politiques de soutien au coton des États-Unis.

Pourtant, rien ne semble arrêter les aides d'État ou subventions. Des aides directes ou indirectes sont fournis aux constructeurs d'automobiles. L'Union européenne aurait annoncé, il y a quelques mois, de nouvelles aides à l'exportation pour le beurre, le fromage et le lait en poudre.

Apparemment, la réglementation de l'OMC et l'application qui en est faite ne permet pas de régler toutes les questions relatives aux aides d'État et subventions. Certes, il existe un organe de règlement des conflits pouvant permettre d'obtenir le retrait d'une subvention ou la suppression de ses effets négatifs. Mais on sait aussi le coût prohibitif pour les pays pauvres des procédures de l'organisme mondial sans compter l'ambiguïté, la difficulté d'interprétation et, selon certains, l'incohérence de ses textes. Le citoyen d'un PMA ne peut pas aussi ne pas s'interroger sur la réelle valeur dissuasive des « contre – mesures appropriées » et des « mesures compensatoires ».

3. Conclusion

Ces interrogations ne sauraient remettre en cause l'existence de l'OMC qui, du reste, a rendu des décisions contre des pays développés. Ce qu'il faut reconnaître, c'est que la question des subventions et des aides d'État est complexe. Justifiées ou non économiquement, elles peuvent toujours l'être sur le plan politique pour tous les pays. Comme elles peuvent fausser la concurrence et perturber le commerce mondial, elles ont besoin d'être régulées pour éviter les antagonismes et les féroces rivalités d'antan. La paix du monde l'exige. A notre avis, le problème des aides et subventions d'État ne peut trouver une solution que dans le cadre de la nouvelle gouvernance mondiale rendue nécessaire et souhaitable par la crise financière internationale.

Cette nouvelle gouvernance mondiale dans le cadre de laquelle seront coordonnées les différentes politiques de concurrence (au besoin par la mise en place d'un organe suprême) combinera un ensemble de règles d'ordre économique, juridique et autres... L'éthique, l'équité, la justice y auront une grande place. Surtout, cette nouvelle gouvernance des aides d'État et des subventions dans un cadre plus global de gouvernance mondiale devra nécessairement tenir compte des impératifs de développement et de la situation de crise permanente dans laquelle se trouvent certains pays en développement et les PMA.

SPAIN

1. State aids in Spain

1.1 State aids in Spain: Order of magnitude, goals and affected sectors

In Spain, State aids are granted regardless of the nationality of the recipient; both Spanish and foreign companies meeting the specified requirements are equally able to benefit from State aids provided they are either resident or located in Spain.

The CNC *Annual report on public aid awarded in Spain* of June 2009 shows the most significant State aid figures disaggregated according to diverse criteria. In the report, *State aid* is defined as any public expenditure which may constitute an economic advantage to a company. The figures in the report correspond to State aids notified to, and authorised by, the European Commission (EC) and to State aids exempted from prior notification but subject to communication to the EC. Unfortunately, it is difficult to obtain data corresponding to State aids falling below the *de minimis* thresholds.

In absolute terms, State aid granted in Spain in 2008 - notified or exempted from prior notification, including crisis aid and excluding public financing for railways¹ - amounted to €6.2 billion,² representing 0.56% of Spain's GDP (€5.3 billion, 0.51% of GDP, in 2007). The period 2003 to 2008 revealed a decrease in State aid in the first year and an upward trend in subsequent years, which is expected to be confirmed in 2009 as a result of the measures implemented to tackle the international financial crisis.

The vast majority of State aid is concentrated in the industrial and services sectors, followed far behind by agriculture-fisheries and transport. In 2008 the bulk of State aid was allocated to industry and services (0.48% of GDP compared to 0.41% in 2007), whilst State aid allocated to agriculture-fisheries and transport has remained stable in relative terms over the past recent years (0.06-0.08% of GDP in agriculture-fisheries, and 0.01- 0.02% of GDP in transport).

In the process of allocating State aid, horizontal objectives (78.9% of State aid in 2008) are more and more preferred to sector objectives (21.1% of State aid in 2008). Horizontal objectives relate to regional development (39% of State aid in 2008), research and development (18.8%), environment (11.7%), SME (3.4%), training (1.4%) and employment (0.8%). Sector objectives include assistance to coal mining (18.5% of State aid in 2008) and, far behind, assistance to the financial sector, to shipbuilding, to ailing companies and to certain other manufacturing activities and services.

¹ A large amount of public financing for railways does not need to be notified to the Commission, either because it does not constitute State aid within the meaning of Article 87 of the EC Treaty or because it is exempted from notification in accordance with Regulations 1191/69 and 1192/69.

² 1 billion = 1,000 million.

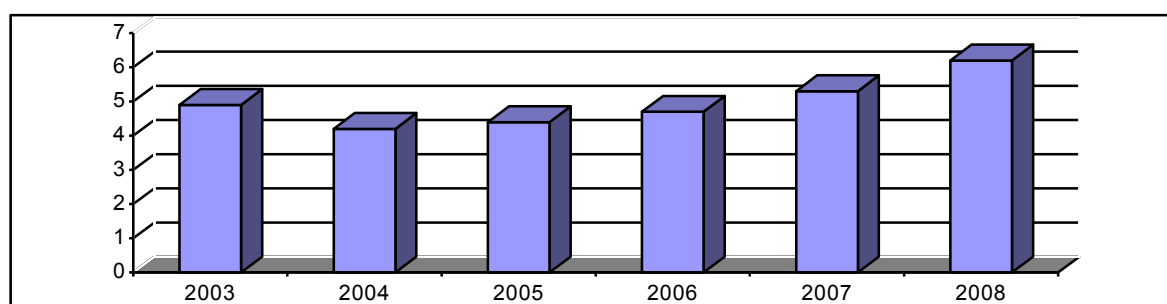
Figure 1. State aid time history in Spain 2003-2008 (in billion EUR)

Source: State Aid Scoreboard Autumn 2009

State aids are most commonly granted through full transfer to the beneficiary, mainly through direct subsidies, although aids in the form of guarantees have been climbing in recent years.

1.2 Access to government-owned or government-controlled inputs in Spain

The Spanish legislative framework establishes free competition mechanisms for access to the use of government-owned or controlled inputs.³

In Spain, Public Administrations manage two kinds of government-controlled inputs: goods of public domain and patrimonial goods.⁴ There three possible types of use for goods of public domain: common, special and exclusive use. Both special and exclusive use are subject to obtaining an empowering title which may consist on either an authorisation or a concession:

- *Authorisations* are granted directly to petitioners who are eligible. If the number of authorisations is limited, then a free competition scheme is applied where appropriate -otherwise authorisations are granted by drawing lots-. Their length is limited to 4 years maximum;
- *Concessions* must be granted under a free competition scheme, but it is possible to directly grant the award under exceptional circumstances -e.g. if a previous auction or contest had been unsuccessful, if the acquirer is either another public administration or a public-utility non-profit organisation-, which must be duly justified. Their length is limited to 75 years maximum.

Notwithstanding the peculiarities established by the sector regulation -the case of telecommunications and natural resources, for instance-, of preferential application, arguably the above mentioned general principles are applicable to all sectors.

³ Ley 33/2003, de 3 de noviembre, de Patrimonio de las Administraciones Públicas.

⁴ Patrimonial goods -such as real property-, may be exploited by contracts which will normally be awarded under a free competition scheme. Only if the goods are peculiar, demand is limited or exploitation is urgent, contracts may be directly awarded. The maximum length of the contracts is 20 years.

2. Aid to ailing companies, especially in the context of the financial crisis

2.1 EC competencies to control the state aids granted by the Member states

The EC exercises supervisory powers over State aids -above certain thresholds- granted by the member States. This, of course, also applies to public aids granted in Spain. Thus, in order to be authorised by the EC, Spanish public aids must comply with EU rules on State aids.

Following the deepening of the financial crisis in the autumn of 2008, the EC provided guidance in the form of Communications on the design and implementation of State aid in the crisis context.⁵

2.2 Spanish state aids in the context of the financial crisis

The following paragraphs summarise the main Spanish State aid schemes designed in the context of the financial global crisis that have been notified to the EC and have subsequently been authorised.

- In the financial sector:
 - *State aid NN 54/A/2008 Fund for the Acquisition of Financial Assets.*⁶ Its objective is to provide credit institutions with liquidity and to encourage them to grant more credit to businesses and households. The Fund, financed by the State Treasury with €30 billion (expandable to €50 billion), purchases high quality assets from volunteer credit institutions at market prices in order to provide them with additional liquidity. The financial instruments for the investment must be selected taking into consideration the principles of objectivity, security, transparency, efficiency, profitability and diversification;
 - *State Aid NN 54/B/2008 Spanish Guarantee Scheme.*⁷ The State guarantee would cover, against remuneration, the issuance of notes, bonds and obligations admitted to the official secondary market in Spain. The maturity of the financial instruments covered is in principle between three months and three years (up to five years in exceptional circumstances). The scheme's overall budget is set at €100 billion, which may be increased to €200 billion depending on the market conditions. Only solvent banks have access to the guarantee scheme. It covers a period of six months following which it must fade or extended prior notification to the EC. The scheme contains elements of State aid but foresees various safeguards aimed at ensuring that the State intervention is proportionate, limited to what is necessary and set through adequate instruments.

⁵ See Communication on the application of State aid rules to measures taken in relation to financial institutions in the context of the current global financial crisis, OJ C 270, 25.10.2008, p. 8 ("the Banking Communication"); Communication on the recapitalisation of financial institutions in the current financial crisis: limitation of aid to the minimum necessary and safeguards against undue distortions of competition, OJ C10, 15.01.2009, p. 2 ("the Recapitalisation Communication"); Communication on the treatment of Impaired assets in the Community Banking Sector, OJ 72, 26.03.2009 ("the Impaired Assets Communication"); Communication on the return to viability and the assessment of restructuring measures in the financial sector in the current crisis under the State aid rules, OJ C 195, 19.8.2009; Communication on the temporary framework for State aid measures to support access to finance in the current financial and economic crisis, adopted on 17 December 2008; OJ C 16, 22.1.2009, p.1; consolidated version OJ C83 of 07.04.2009.

⁶ Real Decreto-ley 6/2008, de 10 de octubre, de creación del Fondo de Adquisición de Activos Financieros.

⁷ Real Decreto-ley 7/2008, de 13 de octubre, de Medidas Urgentes en Materia Económico-Financiera en relación con el Plan de Acción Concertada de los Países de la Zona Euro.

Besides, the *Fondo de Reestructuración Ordenada Bancaria (FROB)*,⁸ which has just been notified to the EC, includes a series of measures aiming at a triple objective: finance restructuring processes of institutions with insolvency problems, strengthen the resources of institutions experiencing short term difficulties but with good prospects of long-term viability, and maintain confidence in the system by increasing its strength and solvency so that surviving institutions can remain strong and provide credit normally. In connection with the restructuring processes, three phases can be distinguished: (i) the search for a private solution by the credit institution, (ii) the adoption of measures to address weaknesses that may affect the institutions' viability -through the participation of the *Fondos de Garantía de Depósitos* (Deposit Guarantee Funds) in such credit institutions- and (iii) restructuring with support of the FROB. The FROB will have a budget of €9 billion, of which €2.25 billion will come from the Deposit Guarantee Funds and €6.75 billion from the State Budget.

It is worth noting that the regulation creating the FROB fosters private solutions first -minimising the cost to the taxpayer whenever the use of public funds is necessary, avoiding generalised recapitalisation aimed at preserving non-viable institutions, and encouraging the assumption of responsibility by shareholders and managers. On the other hand, under such regulation the FROB may temporarily⁹ acquire securities of financial institutions that need, and apply for, aid in order to reinforce their own resources in view of integration processes.

- In the real economy:

Additionally, for undertakings operating in sectors other than financial, the following aid scheme was notified to the EC: *State aid N 307/2009 Temporary aid scheme for granting limited amounts of compatible aid*. The aim of the scheme is to grant temporary aid to undertakings that have been affected by a sudden shortage or unavailability of credit as a result of the global financial and economic crisis. The scheme provides limited amounts of compatible aid to undertakings until the end of 2010. The aid volume available is estimated €1.400 billion. No aid will be granted to firms that were in difficulty on 1 July 2008, in the meaning of the EU guidelines.

The following State aid scheme aiming at the automobile sector is also worth mentioning: State aid N 140/2009 Competitiveness plan of the automotive sector – Realisation of investments aimed at the manufacturing of more environment-friendly products. The aid will be granted in the form of an interest rate subsidy for investment loans for production of green products, i.e. green cars and car components which contribute to the realisation of green cars. The aid is granted only for projects involving early adaptation to, or going beyond, future EU product standards aiming at increasing the level of environmental protection. The scheme applies to companies of all sizes and its overall budget is €690 million.

3. CNC Advocacy and enforcement in the field of state aid

3.1 *The role of the Spanish Competition Authority regarding state aid*

The Spanish Competition Act (CA) -Act 15/2007, of July 3-, without prejudice of the EC's competences regarding control of EU member States public aid, establishes that the CNC, ex officio or at the request of the Public Administrations, may analyse State aid award criteria with the aim to analyse the

⁸ Real Decreto-ley 9/2009, de 26 de junio, sobre reestructuración bancaria y reforzamiento de los recursos propios de las entidades de crédito.

⁹ There is a need for a commitment by the institution to repurchase when capable.

possible effects of State aid on competition in the markets. The CNC may either issue reports on State aid regimes or individual aids or present proposals to the Public Administrations.

As examples, two recently published reports, one on the Draft Royal Decree establishing measures to support the coal mining sector,¹⁰ and the other on the Proposed Draft Act on Audiovisual Communications,¹¹ which discusses considerations regarding the possible existence of State aid elements in the new system for financing the public broadcasting service. Both reports analyse whether the foreseen measures could constitute State aids, recommending, where appropriate, their notification to the EC.

The CNC acts independently of the Administrations responsible for granting the aid under consideration, and has insisted that such Administrations should adopt a precautionary approach to State aids since an appropriate design will, in many cases, prevent possible harmful effects on competition, which, once produced, are often irreversible.

Furthermore, the CA requires the CNC to issue an *annual report on State aids awarded in Spain*; the first one of which was made public in July 2009.¹²

The report devotes a specific section to the description of the *economic criteria that should guide the evaluation of State aids*. The section emphasises the need to take into account the balance between the presumed benefits of the aids and the harm caused by them -to see whether the first outweighs the second-, not only for the recipient companies, but also for the affected markets and the economy as a whole.

The idea is to raise awareness among the Public Administrations in charge of designing State aids about the need to perform a cost-benefit analysis to make sure that the benefits of the planned State aid compensate the potential distortion of competition trade it may cause. Such analysis should focus on the following aspects:

- The State aid must be justified (solution for a market failure / other common interest goals);
- The instrument used must be proportional, i.e. the same results cannot be achieved through other less intrusive mechanisms and the aid must have a real incentive effect (to be effective);
- The damage caused to competition in the affected markets.

This approach is in line with the so called "new economic approach to State aids", which the EC is planning to adopt and promote in the EU.

Furthermore, the CA provides the CNC with an instrument for State aids *ex-post* control. It empowers the CNC to bring actions before the competent jurisdiction against administrative acts and regulations from which obstacles to the maintenance of effective competition in the markets are derived. This mechanism can be particularly useful in the case of *de minimis* State aids -not controlled by the EC- likely to hinder effective competition in the affected markets.

3.2 Examples of complaints received by the CNC on the subject of state aids

The CNC has received various queries and complaints regarding the advantages that certain public entities would be enjoying by virtue of their privileged access to public contracts. Indeed, these "own

¹⁰ IPN 33/09 Real decreto de procedimiento de resolución de restricciones por garantía de suministro.

¹¹ IPN 11/09, Anteproyecto de Ley de la comunicación audiovisual.

¹² http://www.cncompetencia.es/Administracion/GestionDocumental/tabid/76/Default.aspx?EntryId=30675&Command=Core_Download&Method=attachment.

means of management and technical services of the Public Administrations” can be directly awarded contracts for the provision of goods and services to the Public Administrations which would otherwise require a public tender.

Extensive use of this figure could, then, eliminate competition in cases where it is desirable and thus, the CNC has advised a very restrictive use of it by the Public Administrations.

Other complaints and reports have referred to alleged predatory strategies by public bodies due to their funding advantages, which allow for cross-subsidisation between public interest activities and free market activities.

An example in the insurance sector is case ASPA/ASEPEYO (Proceedings R 734/08, Decision of 30 October 2008), where an association of insurance companies filed a complaint against some Social Security mutual insurance companies on grounds that they were subsidising activities subject to free competition with the Social Security funds received in payment for protected activities.¹³ In cases *Centros Deportivos Benicarló* and *Centros Deportivos Castellón*, local authorities were accused of offering sport services in public premises at predatory prices.¹⁴

3.3 *Competition law and state-owned companies*

The CA applies to both public and private undertakings without distinction, as did the previous Competition Act of 1989. The CA defines an undertaking, subject to competition law, as any person or entity carrying out an economic activity, regardless of its legal form and the manner in which it is financed. Thus, the recipient of the prohibitions of articles 1 to 3 of the CA -prohibiting anticompetitive agreements, the abuse of dominant positions and the acts of unfair competition which affect the public interest through distortion of free competition- is any entity involved in an economic activity, i.e. any natural or legal person who independently participates in the production or distribution of goods and services, regardless of its legal status, financing and corporate form, and their public or private nature.¹⁵

When establishing the Competition Authority’s competence to assess Public Administrations’ conducts, the key is to identify whether, at the time, they were acting as regulators (in the broadest sense, including when they were acting in the exercise of any public prerogatives) within the scope of their responsibilities, or just as economic operators. Only in the second case the conduct of the Public

¹³ The Council did not think that the accusation had been proven.

¹⁴ Decisions of 10 March 2006. In these cases no abuse was found. The prices offered had been in line with costs in compliance with the rules governing local finance departments and the classes offered had not been intended to eliminate other competitors from the market but to achieve objectives such as promoting exercise and sports among its citizens. Neither did the Competition Authority find a serious distortion of competition in the market nor an impact on the public interest.

¹⁵ The prohibitions of articles 1 to 3 do not apply to conducts harboured by Law, as stated in article 4 of the Competition Act, regardless of the public or private nature of the concerned undertakings. By contrast, the anticompetitive conducts by firms that emerge from the exercise of other administrative powers or caused by the action of public authorities or entities without this legal protection are not exempted. Even if the law allows anticompetitive conducts that cannot be prosecuted by the Competition Authority, the law itself could be breaching article 86 of the European Treaty. In respect of public undertakings, undertakings granted with special or exclusive rights and undertakings that operate services of general economic interest, this article establishes that member States shall neither enact nor maintain in force any measure contrary to the rules contained in this Treaty, in particular the rules on competition.

Administration would be subject to competition rules. This criterion emanates from the doctrine of the Spanish Competition Authority, upheld by the revision Courts.¹⁶

The Competition Authority has prosecuted and fined several public undertakings. Some examples are hereby presented:

- For participating in anticompetitive agreements: In 1997, *La Lactaria Española S.A.*, a public enterprise attached to the Ministry of Agriculture, was sanctioned with a fine of €1.01 million for leading a cartel of industrial dairy firms that agreed on the basic prices, quality bonuses and discounts for raw milk. Total fines reached € 6.61 million;¹⁷
- For abusing a dominant position: *La Sociedad Estatal Correos y Telégrafos*, the State postal service, a 100% State-owned public limited company has been fined several times for abuse of dominance. In 2003 and 2004 the sanctions rose up to €5.4 million¹⁸ and €15 million¹⁹ respectively. In both cases, the enterprise had taken advantage of its dominant position in the market in which it held a monopoly to prevent new entrants in a connected liberalised market;
- Commitments: In the context of case 2458/03 CORREOS/ASEMPRE. The State postal service committed to implement prices above costs.

In case Ports of Andalusia,²⁰ no sanction followed as the abuse of dominance could not be proven, but the CNC warned that the fact that the public enterprise was acting as regulator and as an economic operator in the same market could cause severe distortions on competition due to asymmetric information problems and biased incentives in the drafting and implementation of the regulation.

¹⁶ As an example, case r 267/97 Tragsa 3, case r 409/00 Seguridad marítima, case r 447/00 Piñas Andalucía, case r 621/06 CST/ AENA, case r 572/03 Servicios Deportivos Logroño, case 2779/07 Consejo Regulador de Denominación de Origen Vinos de Jerez y Manzanilla de Sanlúcar.

¹⁷ Case 352/94, Industrias lácteas.

¹⁸ Case 542/02, Suresa-Correos.

¹⁹ Case 568/03, ASEMPRE/Correos.

²⁰ Case R 718/07, Puertos de Andalucía.

CHINESE TAIPEI

1. Introduction

There is no general state aids policy in Chinese Taipei. However, competent authorities set regulations for various government subsidies. The majority of government subsidies are for the promotion of agriculture and fisheries, the development of mass transportation, industry, outlying islands or remote areas, and trading business, or the protection of the victims of national disasters.

In preparing the present submission, the Fair Trade Commission (hereinafter “the FTC”) consulted with various government agencies responsible for government subsidies, including the Bureau of Energy, the Industrial Development Bureau, and the State-Owned Enterprise Commission which are under the Ministry of the Economic Affairs, as well as the Council of Agriculture. This submission will focus on issues related to the use of government subsidies and legal restrictions, as well as outline some cases of subsidies handled by the FTC for illustration.

2. The use of government subsidies in Chinese Taipei

Since Chinese Taipei joined the WTO in 2002, measures for related industrial subsidies have complied with the WTO regulations and the WTO has been regularly notified pursuant to the WTO Agreement on Subsidies and Countervailing Measures. A number of examples of the subsidy measures, preferential loans, and tax exemptions for agriculture, fisheries, and industry in Chinese Taipei are explained as follows.

2.1 *Agriculture: Companies in the Pingtung agricultural biotechnology park*

Biotechnology companies moving into the Pingtung Agricultural Biotechnology Park may apply for subsidies to offset the costs of the following activities:

- The planning or development of technology that may be vital, innovative, integrative, common, or fundamental to the agricultural biotechnology industry;
- The planning, development, or establishment of a service platform, system, or model that helps the marketing, distribution, application, or value-added service of the agricultural biotechnology industry;
- The planning, development, or establishment of innovative business models or procedures that promote knowledge creation, circulation, or value-added to the technological development of the agricultural biotechnology industry; and
- Other research or development activities that create specific knowledge capital, redefine the value of the agricultural biotechnology industry, or improve the industrial capacity for innovation.

The subsidy to be granted is not to exceed 50 percent of the budget for research and development in the applicant's proposal. In addition, the total subsidy allocated for each proposal is not to exceed one million New Taiwan Dollars (NTD).

Preferential loans at below-market rates: Companies moving into the agricultural biotechnology park may apply for preferential loans with an annual interest rate of 2%. Since January 15, 2009, the interest rate has been reduced to 1.5%. A total of NTD 146.03 million in loans has been approved. The amount of the interest subsidies is NTD 2.19 million (based on the interest rate level of 3% in financial markets).

2.2 Fisheries

2.2.1 Fishing vessels buy-back

Due to severe overfishing worldwide, the UN has been urgently calling on nations to reduce their fishing capacities. Chinese Taipei implements a "fishing vessels buy-back programme" to alleviate pressures on the dwindling fishery resources and ensure their sustainability. The beneficiaries are owners of all varieties of fishing vessels with valid fishing licenses, including recreational fishing vessels.

Funds expended on buying back 90 fishing vessels and 262 fishing rafts in 2007 totalled NTD 485.53 million; funds spent on buying back 127 fishing vessels and 333 fishing rafts in 2008 totalled NTD 741.314 million.

2.2.2 Fishing vessels marine insurance grants

To insure fishing vessels against marine disasters, Chinese Taipei provides grants to cover part of the costs of insurance for fishing vessels in case of damage at sea. The budget for this part totalled NTD 78.4 million in 2007 and NTD 83.5 million in 2008.

2.2.3 Fishing vessels reduction programme

Due to severe overfishing worldwide, the UN has been urgently calling on nations to reduce their fishing capacities. Chinese Taipei implements a "government compensation for fishing vessels reduction programme" to alleviate pressures on the dwindling fishery resources and ensure their sustainability.

The beneficiaries are owners of big-eye tuna long-line fishing vessels with valid fishing licenses and ultra-low temperature freezing equipment. They have been compensated with NTD 30,000 for each gross ton. Funds spent on reducing 23 fishing vessels in 2007 totalled NTD 451.26 million.

2.3 Industry

2.3.1 Tax credit for investment in a disadvantaged region

With the overall objective of achieving balanced economic growth within Chinese Taipei, the aim of the tax credit programme is to encourage investment in disadvantaged geographical regions.

Any company incorporated under the Company Law, which makes an investment in a region with scant natural resources or with slow development, may gain credits of up to 20 percent of the total amount of its investment against the corporate income tax levied in the then current year, provided it meets the threshold of capital or the threshold number of employees. If the amount of corporate income tax levied in that year is less than the tax credit, the balance of the tax credit may be applied against the corporate income tax levied in the ensuing four years.

The threshold capital refers to the total amount used in procuring brand-new machinery, equipment and buildings which adds up to NTD 25 million. The term “minimum number of employees” refers to the monthly average of the number of newly-employed employees in a full year, amounting to fifty persons or more.

2.3.2 *Specific and urgent financing and loans intended for working capital needed during periods of economic crisis and recession, and for recovery plans from damage caused by major natural disasters*

According to Article 2 of the “Standards for Identifying a Small and Medium-Sized Enterprise”, an SME is a company or commercial enterprise registered in accordance with the law with capital or operating revenue below the following thresholds:

- For enterprises engaged in manufacturing, construction, mining or excavating, a paid-in capital of less than NTD 80 million;
- For enterprises engaged in other economic activities such as agriculture, logging, fishing, the raising of livestock, utilities, commerce, transport, warehousing, communications, finance, insurance, real estate, commercial, social or individual services, an annual operating revenue of less than NTD 100 million.

Qualified SMEs in circumstances meeting the following conditions are entitled to apply for financing and loans:

- Urgent financing is provided for the provision of working capital during periods of significant financial crisis, recession and major natural disasters;
- The loans are provided for helping enterprises restructure during periods of economic crisis and recession, replacing machinery and purchasing new automated equipment.

2.3.3 *Duty and tax exemptions for high-technology industries*

In order to stimulate the research and innovation of industrial technology and to promote the development of advanced technology in Chinese Taipei, the “Science-based Industrial Park” (the Park) has been established by introducing sophisticated industries and personnel with advanced technological backgrounds into a designated zone.

A park enterprise refers to a science-based industry and to an enterprise approved and established in the Park that is able to provide services in respect of operational, management or technical support to science-based industries.

All Park enterprises are entitled to the following exemptions:

- Customs duties, commodity tax, and business tax on imported machinery and equipment, raw materials, commodities, fuel, and semi-finished products; and
- Commodity tax and business tax on exported goods or labour services.

According to Section 2, paragraph 1, Article 3 of the Commodity Tax Statute and Article 7 of the Value-added and Non Value-added Law, exports can be exempted from commodity tax and the business tax rate on exported goods is zero. These tax treatments are not specific to enterprises located in the Park, as they are generally available for exported goods, regardless of whether or not the manufacturers are located in the Park. The total amount of business tax exemptions for all imports was NTD 42,298 million and NTD 34,045 million in 2007 and 2008, respectively.

2.3.4 Subsidies for the establishment and operation of petroleum facilities in mountain and offshore areas

According to Article 36 of the Petroleum Administration Act, the Petroleum Fund will be used for some purposes, such as subsidising the setting up of petroleum facilities in mountain and offshore areas as well as transportation outlays, and offering price subsidies. The policy objective is to maintain oil supplies from reserves located in mountain and offshore island areas.

Building contractors and/or operators of petroleum facilities in mountain and offshore island areas are entitled to apply for the following subsidies:

- Subsidy for the establishment of petroleum facilities in mountain and offshore island areas;
- Subsidy for the cost of maintaining petroleum facilities in mountain and offshore island areas;
- Subsidy to offset the cost of shipping petroleum or Liquefied Petroleum Gas to mountain and offshore island areas;
- Subsidy for extra personnel costs in the operation of petroleum facilities in mountain or offshore island areas.

The total amount of such subsidies was NTD 199 million and NTD 245 million in 2007 and 2008, respectively.

2.4 Fund granted for promoting the development of industrial technology

According to the Regulations of Subsidisation for Encouraging Enterprise R&D Activities, any company established according to the Company Law with sound financial standing and a Research and Development Department that has made significant achievements in the past, and which is currently staffed by competent specialists, may apply for this fund to offset the costs of the following activities:

- The planning or development of industrial technologies that may be aptly characterised as vital, innovative or integrative;
- Development of innovative or integrative manufacturing technology by small and medium-sized businesses;
- Development of innovative IT application systems;
- Development of innovative business models based on strategic services-oriented research;
- Cooperation with major national technology-related policies and the creation of an environment conducive to the development of technology and industry within civilian business enterprises.

The assistance funds to be granted shall not exceed 50 percent of the total amount of the following expenses:

- Costs incurred for full-time and/or part-time research personnel;
- Costs of consumable instruments and raw materials;
- Costs for the use and maintenance of R&D equipment;
- Costs for technology transfer; and
- Domestic and overseas travel expenses.

The total amount of the grants in the fiscal year 2007-2008 was NTD 6,571 million.

3. Legal restrictions and subsidies

The FTC does not exert control on state aids in Chinese Taipei. In case a government agent grants subsidies for necessary policy consideration, the nature of the subsidies can be a public law matter or a private economic activity. However, the FTC will properly intervene if relevant trading activities derived from subsidies affect market competition in violation of the provisions of the Fair Trade Act.

Cases concerning farmers associations and consumption cooperatives that have required the FTC's enforcement are described as follows:

3.1 *The farmers association subsidising farmers on pesticides*

Pursuant to Articles 4 and 40 of the Farmers Association Act, the farmers association provides farmers with subsidies on pesticide purchase, and a fund was obtained from the profits of a farmers association allocated for agricultural extension (62% of the profits). Since the conduct for subsidies on pesticide purchases provided by the farmers association was likely to impede the fair competition with pesticide wholesalers and retailers, the FTC organised a meeting entitled "The feasible scheme for subsidies on pesticides by the farmers association and other issues related to the agricultural policy involving the Fair Trade Act" to exchange views with the Council of Agriculture in November 2000. Some of the outcomes are described as follows:

- Relevant authorities will supervise the farmers associations so that they do not to sell pesticides to members at a price lower than the purchasing price;
- If the farmers association, under the statutory requirement of the Farmers Association Act, uses profits to subsidise certain materials for agricultural production, (1) in addition to pesticides, other materials may also be subsidised; (2) the beneficiaries of subsidies on pesticides are agricultural factories and plants under the Taiwan Provincial Farmers' Association, and (3) the subsidies on pesticides are mainly for pest control, not for general purposes;
- When the farmers association sells pesticides which are not produced by agricultural factories and plants under the Taiwan Provincial Farmers' Association, the selling price may not be lower than the purchasing price. Individual cases involving unfair competition will be handled by the FTC according to the Fair Trade Act;
- Regarding the ad hoc government subsidy programmes on pesticide purchase for farmers in the production-and-marketing groups, the township farmers associations shall inform the production-and-marketing group of the following: pesticides can be purchased from either the farmers association or pesticide retailers;
- The application for government subsidies by the township farmers association for pest control projects shall be strictly reviewed. Subsidies will not be granted if they are not to meet an emergency or for specific needs.

3.2 *Tax exemptions are specific to consumption cooperatives, and not applicable to general retailers*

Paragraph 2, Article 3-1 of the Cooperatives Act provides that "A cooperative other than prescribed in the above paragraph shall be restricted by the following provisions unless it is entrusted by the government or a public welfare association: ... 3. Supply cooperatives and consumption cooperatives may not provide or sell goods to anyone other than members..." Hence, cooperatives may not trade with non-members.

Article 7 of the same Act states, “cooperatives may be exempted from income tax and business tax.” As a result, pursuant to Subparagraph 10, Paragraph 1, Article 8 of the Value-added and Non value-added Business Tax Act and Subparagraph 14, Paragraph 1, Article 4 of the Income Tax Act, cooperatives are entitled to tax exemptions when selling goods to members.

In 2000, the FTC consulted with the Ministry of the Interior and Ministry of Finance in order to facilitate fair competition between general retailers and consumption cooperatives and advise those agencies to abolish the provisions regarding income and business tax exemptions for consumption cooperatives. In the initial result, there is no consensus on this issue.

The position of the Ministry of the Interior responsible for the Cooperatives Act is as follows:

Cooperatives refer to the associations organised based on the principle of equality and mutual aid. Cooperatives are public legal entities pursuing improvement of the economic benefits and living standards of members by means of joint operations. Cooperatives and private companies are different in nature. The latter seek to pursue profits, while the former seek to encourage the self-reliance of disadvantaged groups and alleviate the government’s burden in providing assistance. Article 145 of the Constitution stipulates that cooperative enterprises shall receive encouragement and assistance from the State.

The deal between cooperatives and its members is an internal affair rather than an external profit-making activity; therefore, consumption cooperatives can be exempted from income tax and business tax. In addition, cooperative enterprises are beneficial to their members and can stabilise the prices of commodities, and thus the provisions for tax exemptions for cooperative enterprises shall be retained.

The position of the Ministry of Finance is that the provisions for such tax exemptions will be abolished and amended after the Ministry of the Interior deletes relevant regulations.

Recently, in response to the deregulation policy in Chinese Taipei, the Ministry of the Interior started to amend the Cooperatives Act. The objective of the draft amendments to the Cooperatives Act is to improve the competitiveness of the cooperative enterprises in the relevant markets and encourage the development of the cooperative enterprises. In taking into consideration the above items with a view to establishing the cooperatives, the amendments to the Cooperative Act did not delete the provisions of the tax exemptions, and the tax exemptions will thus even apply to non-members. As no consensus could be reached over the controversy which followed with regard to the purpose and principles of the Cooperative Act, a draft amendment for Parliamentary review was returned to the competent authority in October 2009 for redrafting. The draft amendment did not, however, adopt the FTC’s suggestions as mentioned above, and the FTC will continuously make efforts to advocate competition and will closely watch future developments concerning draft amendments to the Cooperative Act.

UKRAINE

Establishment of the state aid system is gaining a great importance under the conditions of market reorganisation and Ukraine's active integration into the international community.

Governments of many countries apply state aid instruments for achieving a wide range of economic, social and political goals, including the improvement of competitive ability of national manufacturers at international and national markets.

The assignment of the state aid system consists not in restricting the state entitlement to render economic aid or to narrow down the scope of such aid, but in ensuring the provision of such type of aid so that it would not bring about any negative consequences for competition.

State aid in Ukraine is provided by central and local agencies of public authorities, local government agencies and their authorised establishments at the expense of the state and local budgets. State aid is annually granted to thousands of business entities. All these elements constitute the expanded and comprehensive system of state aid that requires monitoring and control for the avoidance of adverse effect for competition.

Ukrainian state aid related laws are characterised as fragmentary and incomplete. Certain provisions of state aid control are contained in the Economic Code, The Economic Competition Protecting Law of Ukraine, The Concept of State Subsidies Restructuring (approved by the Cabinet of Ministers Resolution No. 182-p dated March 31, 2003).

The provisions for granting regional aid are determined by The Regional Development Incentives Law of Ukraine. Supporting activities in certain industries are provided for by several laws: The Concept of State Industry Policies (approved by the President of Ukraine Decree No.102/2003 dated February, 12 2003), The State Industry Development Program for 2003-2011 (approved by the Cabinet of Ministers Resolution No. 1174 dated July 28, 2003).

Furthermore, The Fiscal Code of Ukraine provides the possibility of granting subsidies to enterprises at the expense of budgetary funds via financing the support programs on priority branches of economy in accordance with the general national programs, and reducing budgetary incomes on account of granting tax benefits. The Taxation System Law of Ukraine provides incentives for enterprise production activity and active investments by introducing the taxation-related benefits on the profits (incomes) aimed at production development.

International obligations of Ukraine in the sphere of control of the state aid provision and use are determined by Article 49 of The Partnership and Cooperation Agreement of Ukraine, European Communities and their member-countries which provides the Parties abstaining from granting any state aid to certain enterprises or to production of commodities, or from rendering the services that impair or threaten to impair competition on condition of their affecting the trading process between Ukraine and the Community. The information exchange procedure on request of the Parties to the Agreement and proper advising are also provided with regard to certain cases of state aid granting.

Signing the Free Trade Area Agreement with the EU will provide the prohibition of the state aid that impairs competition, if such support adversely affects trading between Ukraine and the EU. Ukraine will

be obligated to ensure legal, institutional and organisational principles of the state aid system, and non-fulfilment of these obligations entails applying a dispute settlement mechanism including certain compensatory procedures.

The issue of state aid granting is only partially regulated by the economic competition protecting laws of Ukraine - with regard to prohibiting the authorities and the local government agencies to grant benefits and other preferences to individual business entities that place them on a privileged footing in relation to competitors which brings about or may bring about non-admission, removal, restriction and impairment of competition. But nevertheless, the concept of “benefits or other preferences” is not fully compliant with the notion of “state aid” present in the EU laws. Besides, the law provides no grounds for reimbursing the state aid that impairs competition. The most important disadvantage is the fact that Ukraine does not still have a consistently formed state aid monitoring system which serves as a prerequisite for any control.

Over the last five years, by order of the Government, the Anti-Monopoly Committee of Ukraine had been attempting to conduct integrated lawmaking in that sphere via the Supreme Council of Ukraine or to apply amendments to the current competition laws with the purpose of performing state aid control functions. Both bills were rejected by the Supreme Council of Ukraine.

One of the main reasons for rejecting the bills mentioned above was a lack of common attitude toward the institutional principles of the state aid control system, first of all, as to determining the authority that would be responsible for performing the control functions of the kind.

The issue of evaluating the effect the state aid makes on competition is only one of the aspects of the state aid institute. The issues of state aid monitoring and preparing reports on granted state aid that shall be obligatory elements of the control system are not in power of the Anti-Monopoly Committee of Ukraine. Nowadays certain elements of these authorities have been conferred to the Ministry of Finance, the Ministry of Economy and branch ministries; however each of these agencies is solely responsible for a certain sphere of social relations. There is no unified agency that would be authorised to perform the whole set of functions provided by the state aid control system.

In view of the aforesaid, pursuant to the Order of the Ukrainian Government, an interagency workgroup specialised on drafting the Concept of the state aid system forming was set up in July 2008.

Allowing for the complexity and diversity of the issue related to state aid granting and using, the Anti-Monopoly Committee of Ukraine initiated receiving technical support from the EU for resolving this problem. As of today there has commenced implementation of the EU technical support project named “Adjusting the competition protecting system and the state purchase system of Ukraine in accordance with the EU standards”, one of the components of which is “State aid”. The draft concept of the state aid system forming has been developed on the basis of the results of the interagency workgroup activities and is currently being agreed on by the executive branch authorities.

As determined in the draft Concept, the state aid system forming shall be ensured by the fulfilment of the following key tasks:

- To form the state aid monitoring system on the national level;
- To make up the state aid register containing generalised data on the support granted in Ukraine;
- To create a state aid map for keeping balanced regional development;
- To prepare regular (annual) reports on the scope and forms of state aid in compliance with international standards;
- To introduce surveillance of how the granted state aid influences competition.

Efficient implementation of the tasks mentioned above will allow the forming of two main components of the state aid system in Ukraine – the state aid monitoring system and the state aid control system.

Fulfilment of the first five tasks will form the state aid monitoring system while the implementation of function five will turn it into the state aid control system.

Under the conditions of the difficulties existing in Ukraine when it comes to promoting laws in the sphere of state aid, it is advisable to make use of the experience of Poland and a few other countries of Central Europe that started resolving the problem of state aid control by creating the state aid monitoring system which was forming based on the EU standards.

Forming the state aid monitoring and reporting systems shall be launched on the basis of the Government's resolution and go through stage-by-stage implementation:

- Stage I – organising a pilot monitoring project on state aid granting with the central authorities involved in, creating the registering and reporting models of state aid;
- Stage II – organising the state aid monitoring system on the national level,
- Stage III – setting up the state aid register on the national level using monitoring results, preparing overall reports of state aid on the basis of this register and creating the regional map of state aid.

Expert training related to the monitoring procedure, register opening and report preparations shall be provided for the authorised agency and also for the central and local authorities – state aid granters - at all the stages of monitoring and reporting.

In order to carry out the state aid monitoring procedures, to keep records of state aid and to prepare reports an authorised agency shall be as fully informed as possible about types and schemes of state aid, have financial monitoring skills and ensure liaising with a broad spectrum of government authorities.

As determined in the draft Concept, the optimal institutional model related to solving the issue of forming the state aid system in Ukraine is the allocation of authorities based on fulfilling certain tasks of the state aid system between two government authorities, specifically, vesting the Ministry of Finance of Ukraine with the authorities of monitoring and report preparation as regards state aid using and granting, and the Anti-Monopoly Committee of Ukraine – with those of controlling the state aid influence on competition and international trade. Allocating authorities this way will ensure the possibility of employing staff and information resources, already available in these government authorities.

Resolving the issue stage-by-stage with its complexity and diversity taken into consideration will ensure the possibility of following a more balanced and reasonable approach to resolving all the issues and of amending certain approaches if necessary.

Evaluating an as-is state in the sphere of state aid due to the made-up register and the monitoring activities preceding the law adoption will be conducive to developing adequate and balanced state aid related laws.

Developing a legislative system in the sphere of state aid shall be conducted on a stage-by-stage basis as well and concurrently with implementing state aid monitoring activities:

- Stage I deals with developing the regulatory documents that will determine the procedure of state aid monitoring, and recommended practice of report preparation with EU standards taken into account;
- Stage II deals with developing and adopting a special law of state aid based on monitoring results, that will determine legal, institutional and organisational principles of state aid system functioning;
- Stage III deals with developing secondary laws that shall ensure state aid system functioning to the full extent.

Ensuring the interaction and information exchange for authorised agencies in the sphere of state aid and implementing the mechanisms of preliminary and follow-up control over the state aid influence on competition and international trade shall commence upon the completion of monitoring stage I, particularly, on the basis of the data obtained during the monitoring activities and after adopting the frame law of state aid.

All the stages of implementing the state aid system shall be accompanied by the activities aimed at the extension of public awareness of the state aid system functions and advantages.

The developed draft Concept is currently being reworked by ministries and establishments and agreed upon with all the co-executors. Consulting experts on the technical support project “Adjusting the competition system and the state purchase system of Ukraine in accordance with EU” is continued.

The choice of a certain optimal model of forming a state aid system and its stage-by-stage implementation shall be further based on the most efficient option the decision as to which shall be rendered by the Cabinet of Ministers of Ukraine.

US FEDERAL TRADE COMMISSION

1. Introduction

The United States does not have a system for the direct regulation of government financial aid to firms. In some extraordinary instances, the U.S. Government has provided assistance to industries and firms to address specific exigencies, for example, to protect critical infrastructure, employment, national defence, and the integrity of the banking and financial system.¹ In its recent rescue measures, the U.S. Government has taken steps to limit the possible negative effects of such interventions by restricting the duration and depth of its intervention. U.S. states may provide certain assistance to firms but, under the “dormant Commerce Clause” of the U.S. Constitution, their actions may not discriminate against other states or hinder interstate commerce.

2. State and local level aids and subsidies

The United States does not have a regulatory regime governing state and local aids and subsidies. However, courts have found certain state assistance to violate the Commerce Clause of the U.S. Constitution.² The Supreme Court has held that there is a “dormant” or “negative” aspect of the Commerce Clause that implicitly limits the states’ right to tax or otherwise regulate interstate commerce:

It has been long accepted that the Commerce Clause not only grants Congress the authority to regulate commerce among the States, but also directly limits the power of the States to discriminate against interstate commerce. ... This ‘negative’ aspect of the Commerce Clause prohibits economic protectionism – that is, regulatory measures designed to benefit in-state economic interests by burdening out-of-state competition.... Thus, State statutes that clearly discriminate against interstate commerce are routinely struck down, [...] unless the discrimination is demonstrably justified by a valid factor unrelated to economic protectionism....³

Thus, measures that either discriminate against interstate commerce, because they favour in-state interests, or measures that burden interstate commerce, because (even if they are non-discriminatory) they make it cumbersome for a company to do business in the state, are equally offensive under the dormant Commerce Clause.⁴

¹ This paper does not cover government measures that may indirectly benefit firms, such as those involving infrastructure, research and development, public services, and taxation.

² United States Constitution, Art. I, sec. 8, cl. 3. *See, e.g., Maryland v. Louisiana*, 451 U.S. 725 (1981). In *Maryland v. Louisiana*, the Supreme Court held that a Louisiana statute imposing a first-use tax on natural gas extracted from the continental shelf in an amount equivalent to the severance tax imposed on natural gas extracted in Louisiana unquestionably discriminated against interstate commerce in favour of a local interest and violated the Commerce Clause. *See also, West Lynn Creamery v. Healy*, 512 U.S. 186, 201 (1994), *Cuno*, 386 F.3rd 738, 743 (6th Cir. 2004), *rev’d in part on other grounds sub nom. DaimlerChrysler Corp. v. Cuno*, 126 S. Ct. 1854 (2006), and *Granholm v. Heald*, 125 S. Ct. 1885, 1892 (2005), as discussed below.

³ *New Energy Co. of Indiana v. Limbach*, 486 U.S. 269, 273-74 (1988).

⁴ *See* Diane P. Wood, “Cuno v. Daimler Chrysler, Inc.: State ‘Aids’ from an American Perspective,” *European State Aid Law*, 1/2007, at 7.

States and local authorities regularly provide tax breaks and other incentives to attract new investors.⁵ Generally speaking, a challenged credit or exemption will not survive Commerce Clause scrutiny if it discriminates on its face or if, on the basis of a “sensitive, case-by-case analysis of purposes and effects,” the provision “will in its practical operation work discrimination against interstate commerce,”⁶ by “providing a direct commercial advantage to local business.”⁷ Discrimination means different treatment of in-state and out-of-state economic interest that benefits the former and burdens the latter.⁸ A state tax that discriminates against interstate commerce is invalid unless “it advances a legitimate local purpose that cannot be adequately served by reasonable non-discriminatory alternatives.”⁹

In *Cuno v. DaimlerChrysler, Inc.*,¹⁰ the U.S. Court of Appeals for the Sixth Circuit struck down Ohio’s income tax credit for new in-state investment on the grounds that it violated the Commerce Clause, stating that the income tax credit discriminated against interstate economic activity “by coercing businesses already subject to the Ohio franchise tax to expand locally rather than out-of-state.”¹¹

In *Granholm v. Heald*,¹² the U.S. Supreme Court invalidated laws in Michigan and New York that prevented or deterred out-of-state wineries from selling directly to in-state consumers yet allowed in-state wineries to do so. In finding that the regulations discriminated against interstate commerce in violation of the Commerce Clause, the Court heavily relied on the FTC’s 2003 Wine Report.¹³ Citing the FTC report,

⁵ *E.g.*, in 1994, Indiana passed a law (“Economic Development for a Growing Economy” or “EDGE”) to provide income tax credits for companies that make major job-producing investments in the state. *See* Economic Development for a Growing Economy Tax Credit, Indiana Code 6-3.1-13, *available at* <http://www.ai.org/legislative/ic/code/title6/ar3.1/ch13.html>. South Carolina offered Haier, a Chinese appliance manufacturer, tax credits and other incentives for the construction of a new factory in the state. *See* “Against the Grain: A Chinese appliance maker has placed its bet on a counterintuitive strategy: It’s bringing jobs to the US,” *The Wall Street Journal*, Sept. 27, 2004, at R6. Georgia state and local authorities provided Kia, the South Korean automobile manufacturer, \$410 million in state and local tax credits and other assistance to build a plant employing 2,500 workers in Georgia. *See* “Kia joins Toyota in opening U.S. plants,” *The New York Times*, March 14, 2006, *available at* <http://www.nytimes.com/2006/03/14/business/worldbusiness/14iht-cars.html>. In January 2010, the Michigan Economic Development Corporation approved a \$22 million state tax credit to Tata Consultancy Services to establish a centre in Michigan that will involve an investment of \$125 million and create up to 750 jobs. *See* “Gov. Granholm Announces Over 5,200 New, Retained Jobs for Michigan,” U.S. FED. NEWS (Jan. 20, 2010).

⁶ *West Lynn Creamery v. Healy*, 512 U.S. 186, 201 (1994). In this case, a Massachusetts law imposed a tax on milk dealers for all in-state sales of milk, whether or not the milk had been produced in Massachusetts. The state then distributed the money from the tax only to operators of in-state daily farms. The Court found that it effectively gave Massachusetts producers a tax rebate that was indistinguishable from a discriminatory tax exemption.

⁷ *Bacchus Imports, LTD. v. Dias*, 460 U.S. 263, 272 (1984).

⁸ *Oregon Waste Sys., Inc. v. Dep’t of Env’tl. Quality*, 511 U.S. 93, 99 (1994).

⁹ *Id.*, at 101.

¹⁰ *Cuno*, 386 F.3rd 738, 743 (6th Cir. 2004), *rev’d in part on other grounds sub nom. DaimlerChrysler Corp. v. Cuno*, 126 S. Ct. 1854 (2006) (plaintiffs lacked standing to sue in federal court).

¹¹ *Id.*

¹² *Granholm v. Heald*, 125 S. Ct. 1885, 1892 (2005).

¹³ Staff of the U.S. Federal Trade Commission, “Possible Anticompetitive Barriers to E-Commerce: Wine” (July 2003), *available at* <http://www.ftc.gov/os/2003/07/winereport2.pdf>. The Report explores the ways in which various state governments restrict competition in U.S. wine markets by making it difficult or impossible for out-of-state wine producers to sell wine directly to consumers in other states. After analysing these laws and the justifications given for them, comparing conditions among states with

the Court concluded that the regulations were not the least restrictive alternative for regulating interstate wine sales to minors and facilitating tax collection. The Court said the regulations were “the product of an ongoing, low-level trade war”¹⁴ among the states, and added that it was “evident that the object and design of the Michigan and New York statutes is to grant in-state wineries a competitive advantage over wineries located beyond the States’ borders.”¹⁵

3. Federal government assistance to ailing companies and industries

3.1 History

The U.S. government’s first extensive aid programmes occurred in the 1970s. Penn Central Railroad, on the verge of bankruptcy in 1970, appealed to the Federal Reserve for aid on the grounds that it provided critical infrastructure and transportation services that would otherwise be lost. In 1971, Congress provided Penn Central with \$673 million in loan guarantees. In 1974, Congress approved a package of loans, loan guarantees, and grants for Penn Central and five other railroad companies that were facing bankruptcy. In 1976, Congress established Conrail, a publicly created quasi-private company, to consolidate the freight rail system. The government spent approximately \$7 billion to keep Conrail operating. Conrail started to earn a profit in 1981¹⁶ and the federal government sold its ownership interest in 1987.¹⁷

Lockheed Aircraft Corporation received government aid in the early 1970s. In 1971, Lockheed experienced severe financial troubles. As a result of an appeal by the company’s management to the federal authorities, Congress passed the Emergency Loan Guarantee Act in 1971, granting up to \$250 million in loan guarantees.¹⁸ The aid was motivated by the approximately 60,000 jobs at risk between Lockheed and its suppliers, the potential significant loss in GDP,¹⁹ and the implications for national defence given that Lockheed was a major defence contractor. The Treasury’s aid enabled Lockheed to gradually recover from its financial crisis and win back its creditors’ trust. Lockheed eventually paid off its loans and gave up the government’s guarantee in 1977.

The U.S. government’s assistance to Chrysler Corporation in 1980 was probably the best-known example of government aid to a troubled company in U.S. economic history. Under the 1980 Chrysler Loan Guarantee Act, Chrysler, which was on the brink of bankruptcy, received \$1.2 billion in federal loan guarantees. Treasury Secretary G. William Miller stated, “There is a public interest in sustaining [its] jobs and maintaining a strong and competitive national automotive industry.”²⁰ Chrysler paid back the loan in 1983.

different laws, and conducting an empirical study, the FTC Staff concluded that state bans on interstate direct shipping represent the single largest regulatory barrier to expanded e-commerce in wine and recommended that states allow direct shipping from out-of-state wineries and retailers, as well as from in-state suppliers. *Id.*, at 3 and 40.

¹⁴ *Supra* note 11, at 1896.

¹⁵ *Id.*, at 1892.

¹⁶ An important step towards Conrail’s financial turnaround was the passage in 1980 of the Staggers Act, which allowed railroads to set their own rates according to market conditions.

¹⁷ “85% U.S. Stake in Conrail Sold for 1.6 Billion,” *The New York Times*, March 27, 1987, available at <http://www.nytimes.com/1987/03/27/business/85-us-stake-in-conrail-sold-for-1.6-billion.html?pagewanted=1>.

¹⁸ “The Lockheed Bailout Battle,” *Time Magazine* (Aug. 9, 1971).

¹⁹ The potential loss in GNP from a Lockheed bankruptcy was estimated between \$120 and \$475 million.

²⁰ “Chrysler’s Crisis Bailout,” *Time Magazine* (Aug. 20, 1979).

The last federal assistance programme prior to the recent rescue measures in response to the 2008 financial crisis took place in the airline industry in 2001. Following the September 11, 2001, attacks, the grounding of airplanes hit an already financially troubled industry very hard. To assure the functioning of airlines and air transportation facilities during the crisis, Congress enacted a \$15 billion financial aid package.²¹

3.2 *Rescue measures for banks and car makers in the recent financial crisis*

As a result of the international financial crisis that erupted in late 2008, the U.S. Government established the “Troubled Assets Relief Programme” (“TARP”) pursuant to the Emergency Economic Stabilisation Act (“EESA”). TARP’s goal is to maintain the functioning and integrity of the banking and financial markets and thereby, the broader economy.

EESA authorised \$700 billion of Treasury investments under TARP. Pursuant to TARP’s Capital Purchase Programme, the U.S. Treasury Department and the Federal Reserve Board have invested in 707 U.S. banks.²² TARP’s Targeted Investment Programme invested \$20 billion each in Citigroup Inc. and Bank of America Corp.²³ As of January 2010, approximately \$545 billion has been programmed, although not necessarily disbursed, under various TARP initiatives. The U.S. Government is unlikely to utilise the full \$700 billion in budgetary authority allowed for TARP pursuant to the EESA. TARP has helped U.S. banks to stabilise and several banks that received TARP assistance have started to pay back these loans. As of January 2010, total TARP repayments were over \$165 billion, or two-thirds of total TARP investments in U.S. banks.²⁴

The federal government also provided TARP aid for the automobile industry to “facilitate the restructuring of our domestic auto industry, prevent disorderly bankruptcies during a time of economic difficulty, and protect the taxpayer by ensuring that only financially viable firms receive assistance.”²⁵ The companies were required to make fundamental changes in their management and products as conditions for assistance.

²¹ Air Transportation Safety and System Stabilisation Act of 2001, 49 USC 4010 note.

²² TARP’s Capital Purchase Programme invested \$205 billion in U.S. banks. *See* Report of the Special Inspector General for TARP, available at http://www.sig tarp.gov/reports/congress/2009/July2009_Quarterly_Report_to_Congress.pdf, and Office of Financial Stability, Dep’t of Treasury, Troubled Asset Relief Programme Transactions Report (January 13, 2010). *See* also figure 4 in dep’t of treasury, troubled asset relief programme monthly 105(a) report – December 2009 6 (January 11, 2010) and Office of Financial Stability, Dep’t of Treasury, warrant disposition report 1 (2010).

²³ Office of Financial Stability, Dep’t of Treasury, Troubled Asset Relief Programme Transactions Report 17 (January 13, 2010).

²⁴ *Id.* *See* also Figure 4 in Dep’t of Treasury, Troubled Asset Relief Programme Monthly 105(a) Report – December 2009 6 (January 11, 2010). This consists mainly of over \$122 billion repaid under the Capital Purchase Programme and \$40 billion repaid under the Targeted Investment Programme. *See* Office of Financial Stability, Dep’t of Treasury, Warrant Disposition Report 1 (2010) and Dep’t of Treasury “Treasury Receives \$45 Billion in Repayments from Wells Fargo and Citigroup – TARP Repayments Now Total \$164 Billion,” Press Release (December 22, 2009), available at http://www.financialstability.gov/latest/pr_12232009b.html.

²⁵ The White House, “Fact Sheet: Financing Assistance to Facilitate the Restructuring of Auto Manufacturers to Attain Financial Viability,” Dec. 19, 2008, available at <http://www.whitehouse.gov/news/releases/2008/12/20081219-6.html>.

In December 2008, Congress enacted the Automotive Industry Financing and Restructuring Act, which provided \$14 billion in short-term bridge loans to GM and Chrysler.²⁶ Because the recipients did not present viable restructuring measures, the government announced new initiatives to provide assistance to the industry in the framework of the Auto Industry Financing Programme (2009). The initiatives included programmes that ensured payments to the car makers' largest suppliers, established a warranty commitment programme to cover the possible deterrent effect of bankruptcy, and initiated programmes to respond to job losses and community effects to ease a possible transition process for workers in areas dependent on the automobile industry. The cost of government assistance, including loans, assistance to finance companies, the supplier support programme, and the warranty commitment initiative, totalled \$36.4 billion.

The government's intervention in Chrysler resulted in another auto company's taking substantial ownership of Chrysler and managing its remaining assets. Fiat obtained a 35 percent stake in the new Chrysler, while the U.S. government retained 8 percent following the company's reorganisation. The government pursued a different strategy regarding GM. GM was required to cut about one-third of its work-force, sell half of its brands, make substantial wage concessions, revise health and insurance benefits, and replace its senior management and board of directors. The plan transformed GM into a majority publicly-owned company, with the U.S. government owning 60 percent of the company.

To limit potentially negative ramifications of these rescue measures, the U.S. government has taken steps to ensure that the assistance is transitory and limited to taking ownership stakes that do not compromise the independent direction and management of the company. President Obama recently described this policy in the context of General Motors, but the principles are applicable to other situations as well: "[W]e are acting as reluctant shareholders . . . The federal government will refrain from exercising its rights as a shareholder in all but the most fundamental corporate decisions. . . . In short, our goal is to get GM back on its feet, take a hands-off approach, and get out quickly."²⁷

²⁶ As Ford made a series of significant financial targets in 2006, it allowed the company to cover its own losses and remain independent.

²⁷ Remarks by President Obama on General Motors Restructuring (June 1, 2009), *available at* http://www.whitehouse.gov/the_press_office/Remarks-by-the-President-on-General-Motors-Restructuring/. The policy of limited assertion of ownership has been similar in the banking industry. *See* Remarks of President Obama on the Economy (Georgetown University, Apr. 14, 2009) ("we believe that pre-emptive government takeovers are likely to end up costing taxpayers even more in the end, and because it's more likely to undermine than create confidence"), *available at* http://www.whitehouse.gov/the_press_office/Remarks-by-the-President-on-the-Economy/.

BIAC

The Business and Advisory Committee (BIAC) to the OECD appreciates the opportunity to submit these comments to the OECD Global Forum on Competition on “Competition, State Aids and Subsidies.”

1. Overview

State aids and subsidies have played a significant role in the economy over the past 18 months. From bailouts in the banking and insurance sector to investments in the automotive sector to the funding of major infrastructure projects and technology, these aids and subsidies have significantly helped to mitigate the worst adverse effects of the world financial and economic crisis. The problems of the financial sector undoubtedly necessitated some of these measures, without which major global businesses faced potential disaster and economies may have suffered in ways that would have taken many years to cure. It would be easy, therefore, to suggest that subsidies and state aids should be viewed solely in a positive light if only as a "necessary evil". But the remedial benefits of state aids can also present a significant risk to competition that must not be overlooked. Subsidisation, in whatever form, can tilt the competitive playing field, squelch potential innovation and deter investments by rival firms in ways that can impede the competitive process and lead to both short and long-term harm to consumers. These competing concerns must be reconciled through effective governmental oversight, with the unifying theme being the protection and promotion of consumer welfare.

Idealistically, subsidies and state aids would not feature prominently as a tool of industrial policy as these mechanisms can have the capacity to create distortions in the competitive landscape. Given the economic realities of the times that have led to significant market failures, and the promotion of overriding governmental policy objectives to cure these failures, some level of subsidies and State aids can be seen as necessary to ensure that short term distortions in corporate financial stability do not result in long term elimination of efficient firms that happen to be caught up in turmoil created by constriction in the financial markets. For example, in mid-2008 firms typically could gain access to a long-term financing facility (debt or equity) at reasonable rates and thereby secure the capital required to allow the business to grow and invest for a period of 3-5 years. Six months later, by the beginning of 2009, it was extremely difficult for firms to access capital at any rate and doing so often meant sacrificing or putting at risk substantial assets of the firm even to gain short-term operating capital. The *timing* of a firms' need for re-negotiating long-term capital had nothing whatever to do with the firms' competitiveness, efficiency, innovation or any other competitive metric; it was purely a question of chance. To punish such firms and allow them to go bankrupt in such blameless circumstances could have resulted in perverse competitive results. At such moments, it is appropriate for governments to make public policy decisions that will help firms get past the period of market illiquidity and regain equal footing with the firms that were more fortunate in securing financing prior to the economic crisis. Thus, in BIAC's view, there is an important role for subsidies and State aids that is consistent with the promotion of competition, efficiency, innovation and net consumer welfare that does not require the sacrifice of sound competition principles.

Improperly designed and implemented, however, subsidies and state aids may threaten free competition and consumer welfare. Companies that receive State aids can enjoy some competitive advantage over their rivals that can thwart the competitive process and result in harm to consumers. The McKinsey Global Institute's twelve-year study to determine why some nations remain wealthy and others

remain poor despite years of international aid found that “economic progress depends on increasing productivity, which depends on undistorted competition. When government policies limit competition... more efficient companies can’t replace less efficient ones. Economic growth slows and nations remain poor.”¹ To avoid such a result, clear and non-discriminatory rules, and their effective implementation, are necessary to ensure a level-playing field for companies and to limit the potentially harmful effects of subsidies.

There are three main parties in the subsidies constellation: the State, the beneficiary and its competitors. All three players have their own motivations and goals. The goals of the state may reflect social policy objectives, for example to attract foreign direct investment, maintain employment, increase tax revenues or stimulate growth in a particular economic sector. At the same time, the objectives of the state decision makers may reflect political objectives that are not as focused on long-term consumer benefits. Indeed, for example, it is a well-known international phenomenon that subsidies increase in election years. Thus, not all State aids should be viewed through the same lens of positive social policy and, accordingly, the impact of State aids on competition should be scrutinised as to each individual case.

A beneficiary of the state aid rarely is concerned about the potential harmful effects on the competitive process. For a recipient company at risk, it can be argued that State aids maintain a competitor that otherwise would not exist and, therefore, competition is enhanced. But in the face of decreasing relative demand (i.e., static demand coupled with increased capacity or declining demand coupled with static capacity), the elimination of one or more competitors from the marketplace may be inevitable. In this case, consumers are best served by witnessing the demise of the least efficient competitor rather than the competitor with the lowest degree of state subsidisation.

In general, companies tend to see the short-term advantages of receiving State subsidies: subsidies reduce companies’ costs; they allow investments that would otherwise not have been possible; they can avoid painful restructuring and unrest of their labour force; and they may receive a competitive advantage over their competitors that can be used to achieve a better market position. At the same time, companies often tend to ignore the risks of State subsidies for their future, such as a delay in necessary cost cuts, improvements in efficiency and a focus on innovation.

Such a focus can lead to perverse results, with even competitively efficient competitor companies becoming incentivised to employ, invest and spend in ways that are less efficient. To this end, one may question the substantial subsidies doled out nearly all global automotive companies at the height of the economic crisis.

In sum subsidies have the ability to distort competition and negatively impact consumer welfare because they can lead to inefficient allocations of taxpayers’ money and company resources and because they reduce incentives to reduce costs and create efficiencies. On the other hand, in some cases, subsidies may improve overall welfare, in particular if they correct for market failures unrelated to intrinsic elements of corporate competitiveness or facilitate necessary additional investment in research and development. Given the potential benefits and harms of State aids and subsidies, the consideration and control of such measures can be viewed as a crucial part of an integrated governmental competition policy. We agree with the EC’s fundamental policy that “State aid control is an essential component of competition policy and a necessary safeguard to preserve effective competition and free trade in the single market.”²

¹ Deborah Platt Majoras, Chairman, U.S. Federal Trade Comm’n, “National Champions: I Don’t Even Think it Sounds Good,” Remarks before the International Competition Conference/EU Competition Day, Mar. 26, 2007, available at <http://www.ftc.gov/speeches/majoras/070326munich.pdf> (citing William Lewis, *The Power of Productivity: Wealth, Poverty, and the Threat to Global Stability* (2004), at 103).

² Common Principles for an Economic Assessment of the Compatibility of State Aid Under Article 87.3 at 1, available at http://ec.europa.eu/competition/state_aid/reform/economic_assessment_en.pdf.

2. Objectives of subsidy and state aid control

State aid and subsidies rules should have two main goals. First, they should be implemented in a way that facilitates a level playing field for competition, both on the national and on the international level. Second, they should create a balance between the need to limit the distortion of competition created by subsidies while at the same time preserving legitimate social policy goals of State aids that can help to cure market failures and benefit consumers. We believe that such rules must be based on an economic assessment of the net effect of subsidies.

Such rules could have a national, supranational or international basis. In fact, many rules in different countries, in particular budgetary rules, limit the use of subsidies, even though they are not designed to protect competition or markets. These rules often are intended to prevent domestic abuses in doling out subsidies based on sub-optimal government investments. Purely national regimes, however, are not likely to preserve competition particularly when the scope of effective competition transcends national borders, as is the case in an ever-expanding number of relevant product markets. National governments tend to disregard negative spill-over effects on other countries and prioritise national economic interests over international ones.³

A supranational or international regime is the most effective way to attempt to eliminate the potentially distortive effects of subsidies. Such a supranational State aid regime exists in the European Union. This system relies on an independent regulator and a set of rules that prohibit subsidies that fall outside specified parameters and have not been approved by the regulator. It can be enforced by national and European courts. State aid law has existed in the European Union since the early 1950s. In the last 50 years, the European Commission and the European courts have developed an extensive practice and decision precedent base respect to various questions of State aid law. The Member States of the European Union also developed considerable expertise dealing with these rules and have adapted their behaviour to these rules. The European Commission also has advanced beyond other systems in integrating subsidy and state aid considerations into their competition regime. Yet the impact of the EC system of State aids is limited to the boundaries of the European Union.

The international system of the WTO is rather different from the European system. It does not directly regulate or prohibit subsidies and has no regulator that has to approve subsidies. Rather, the system relies on the ability of States to petition for counter measures to neutralise subsidies granted by other States and to restore a level playing field. These counter-measures, however, are often applied as to products or economic sectors other than the one in which the subsidies were granted, so while the net benefits may theoretically be eliminated, the potential distortive effect is not avoided (and arguably is multiplied). Still, the system imposes a beneficial chilling effect on the granting of subsidies.

3. Forms of subsidies and state aids

The most obvious form of subsidisation is direct government grants. Other less obvious forms of subsidies, however, warrant similar treatment when they have a similar impact to direct grants. Under European law, the concept of “State aids” thus covers all economic advantages granted by the State through State resources that grant a specific economic advantage on one or more undertakings or specific industry sectors. Because cash is a fungible good (indeed, that is its sole purpose), subsidies have a direct impact on operational aspects of a firm, regardless of whether those funds are “earmarked” in a particular manner. Subsidy funds can improve a firm’s cash flow, enhance the balance sheet, and build assets that allow a firm to raise additional debt financing or equity capital.

³ *Id.*

In those cases where all companies receive the same economic advantage from a State, such as uniform tax treatment, action typically is not warranted. These measures do not threaten the equality between companies within the State and do not confer any competitive advantage on one or more of the undertakings compared to their competitors. While such measures may only benefit those firms operating within the state, the state is presumably pursuing legitimate social policy objectives by imposing taxes uniformly on all businesses within the state and is not attempting to tilt the competitive playing field. Moreover, firms should not be penalised merely for operating within a state that has preferential tax regulations as compared to other states as this is a component of long term cost and therefore impacts efficiency, albeit not in an operational sense.

Besides direct grants, governments sometimes rely on industry- or firm-specific tax measures such as tax deferrals, lower tax rates or the decision not to collect taxes from a company, guarantees and loans. Governments often prefer tax measures because they allow them to give companies additional economic benefits without having to finance them out of the State budget. The government may also hand out loans to companies at interest rates or against collaterals or securitisation that would not be acceptable to a normal bank; or it may provide guarantees for a company so that it can receive a bank loan that it would normally not have received. The State can also actively get involved in the economy by investing equity into companies. All of these measures should be considered on a par with direct grants and their impact should be evaluated.

At times, this behaviour can resemble or substitute for the actions of a private market participant. For example, the State can grant a loan at market rates against collaterals that are in line with market requirements. Or a State can invest equity in a public undertaking, in particular if the State is already engaged in this undertaking. The State can grant guarantees, for public or private undertakings, if the guarantee would also have been granted on the same conditions, by a private investor. In European Law, the different forms of this behaviour are assessed under a number of closely related tests, the “private investor test”, the “private creditor test”, and the “private vendor test”, each referring to the particular situation in which the State acts like a market participant under unusual conditions.

The private investor test raises the question why the State intervenes in the economy if – by definition – a private investor could have done the same. While these actions can be viewed with some scepticism, they do not always imply subsidisation for two reasons. First, the state may be attempting to remedy a market failure that has prevented a private actor from taking the action. Second, the fact that the state, rather than a private party, has taken such action does not imply harmful effects on competition or consumer welfare.

4. Distortion of competition

Subsidies can result in three types of competitive distortions as outlined by the European Commission in its framework for assessing economic effects of State aids: “First, State aid, by interfering with the allocation of rents through markets, may have long-term dynamic effects on the incentive to invest and compete. Second, at a more specific level, State aids may affect competition in the product market and trigger different responses by competitors depending on the circumstances. Third, State aid may affect competition in the input markets and in particular the location of investment.”⁴

Long term incentives can be adversely impacted because firms may conclude that the availability of State aids can supplant the need for their own investments while still ensuring an adequate rate of return. This can reduce innovation and lead to stagnation. Competitive responses might also be muted as rivals conclude that their investments are not likely to result in a competitive advantage. Input markets can also

⁴ *Id.* at 5.

be impacted as the subsidy may favour one form of input (often labour) over others (such as mechanisation).

The Commission states that in evaluating the distortive effects of State aids, it will principally consider the effect that the recipient's change of behaviour will have on competitors and input suppliers. It notes that it will also consider the impact on consumers. In our view, that prioritisation is skewed: the impact on consumers should be the principal concern of the Commission in implementing its State aid policies, with impacts on competitors and input suppliers a secondary component of that consideration.

The most obvious case of distorted competition concerns the rescue of an inefficient firm in financial difficulties. Keeping such a firm afloat promotes inefficiencies and might harm more efficient competitors, particularly when not linked to a thorough restructuring of the firm. State subsidies can have the effect of reinforcing the very behaviour that the competitive process is designed to discourage. State subsidies risk decreasing pressure on companies to reduce costs, to invest in research, development and innovation and to simply become more efficient. Firms that feel protected may not make the necessary effort to remain competitive without State subsidies. Viable business may become threatened because subsidised and inefficient competitors are able to undercut their prices. Efficient companies may be forced to leave the market or may require State aid themselves to stay in business.

At the same moment, one of the least distortive uses of subsidies is to remedy a failure in the financial markets that artificially restricts the availability of investment or operational capital for firms that are efficient and have the potential to enhance consumer welfare. Distinguishing between market failures and favouritism is a challenging task, but a necessary one if consumer welfare is to be maximised.

5. Designing state aid rules

Clear rules and a uniform and non-discriminatory application of these rules are important to maintain or restore a level playing field for businesses around the world. States should not be allowed to provide competitive advantages to companies without clear justification and transparency.

Standalone national rules cannot be considered a viable enforcement mechanism to limit subsidies and to ensure that subsidies rules are applied in a non-discriminatory way. Moreover, a national agency cannot be expected to effectively police the actions of the government from which it derives its own authority. Particularly in times of economic crisis when decisions on State aids are being made at the executive level, governmental agencies tasked with monitoring subsidies and competition enforcement have had only a minimal role to play and, at times, have been completely disregarded. Therefore, a supranational authority such as the European Commission or an international organisation such as the WTO is necessary to discipline the incentive to grant subsidies to their own undertakings absent compelling social policy objectives.

Rules governing State aids and subsidies should identify legitimate objectives of subsidies including both efficiency, technology and equity objectives, outline the competitive distortions that can result from subsidies, and seek to clearly indicate the way in which the positive and negative effects of subsidies will be considered. The rules should provide for transparency and disclosure of State aids and a means for challenging the grant of any economic benefit conferred upon a firm. Adequate investigative and remedial powers should be granted to the responsible authority to ensure that individual abuses can be remedied and to deter abuses from occurring.

6. Financial and economic crisis

During the recent financial and economic crisis many banks and companies could only survive with the help of massive State subsidies in different forms. This was an extraordinary situation: in a normal

economy, firms in difficulties should not or only in limited circumstances be rescued through State subsidies. The reasoning behind this is that such firms are usually in difficulties because they are inefficient and it would be beneficial for competition and welfare if inefficient firms that are unable to increase their efficiency have to leave the market. However, this reasoning did not apply in the crisis: banks and companies were in difficulties because of the crisis, not necessarily because of their being inefficient.

Refraining from help in this situation would have had serious and unwanted consequences. There was the real danger that the whole financial system would break down, with unknown but certainly disastrous consequences. Furthermore, excluding State subsidies in the crisis would force efficient and inefficient companies alike to exit the market. It would lead to a strong post-crisis concentration in several if not all sectors of the economy, creating oligopolies or monopolies and increasing the likelihood of collusion and cartels. All these consequences would in the medium- and long-run lead to a loss of consumer welfare and a decrease of competition. An aggressive enforcement of subsidies bans would also have put into danger the very existence of State aid rules, given the strong political and economic reasons for granting aid.

We therefore welcome the fact that the European Union, have decided to apply the State aid rules in a way that has helped to overcome the banking crisis while maintaining the principles of the law, in particular insofar as the grants have been accompanied by measures designed to limit market distortions.

Post-crisis rules should reflect the return to a limitation of State aid and should take into account that the potential distortions of competition entailed by the crisis aid need to be cleaned up post-crisis. In fact, the European Commission is currently closely monitoring the restructuring plans of a number of banks that have received subsidies during the crisis.

7. Conclusion

Subsidies and State aids present a challenge for governments seeking to promote optimal competitive outcomes. Properly utilised, subsidies can preserve and enhance a competitive marketplace by correcting critical market failures and help efficient firms to survive and thrive. Improperly used, they can tip the balance of competition toward inefficient firms in order to promote nationalistic and political objectives at the expense of efficiency and innovation. Maximising consumer welfare demands that these competing objectives be closely scrutinised and that distortive practices be remedied.

MR. JOAQUÍN ALMUNIA, COMMISSIONER FOR COMPETITION (EU)**Keynote Speech: "Competition, State aid and Subsidies in the European Union"**

I'm very pleased to be here today in only the second week as Competition Commissioner.

The OECD and its Competition Committee play a very important role in the field of competition. I very much appreciate the quality of your work, and applaud your efforts to achieve greater convergence in competition policy worldwide.

My key priority for the next five years is the same as it was under my previous responsibility as Commissioner for Economic and Financial Affairs: to help overcome the current financial and economic crisis and ensure that Europe emerges better equipped for balanced and sustainable growth and more jobs. This is an ambition which we all share for our respective countries – and the reason why we are meeting here at the OECD, to work together to achieve this ambition.

This is also the aim of the proposals the new European Commission is preparing for what we call "The EU 2020 Strategy": to lay the foundations for a more dynamic, knowledge-based, socially inclusive and greener economy that is both sustainable and fair.

I believe that competition policy has a vital role to play in this regard, by making markets work better, for the benefit of business and consumers.

Competition gives business the tools to succeed on the world stage, by enhancing their competitiveness and encouraging innovation. It helps create viable companies that can offer workers long-term employment prospects. And it gives consumers the benefit of lower prices, better choice and better quality of goods and services.

Competition policy is sometimes thought of as only addressing the behaviour of companies and businesses: cartels or abuses of market power, or mergers whose impact on competition needs to be assessed. But state subsidies to business ("state aid" in EU Treaty language) can also distort competition. A review of the impact of subsidies is, I believe, an important aspect of competition policy.

Subsidies are of course an essential tool for policy makers and governments. Government measures to support the financial system and other sectors of the economy over the past 18 months are a case in point. It is widely acknowledged that the money governments poured or committed in support of financial institutions prevented a catastrophic collapse of the global banking system.

On top of the immediate reactions needed to avoid a meltdown of the economy, in normal times subsidies can help remedy a market failure, promote investment in environmentally friendly technologies, or foster economic and social development in a particularly depressed region. These are important public policy objectives – and it is crucial to ensure that governments have the best-designed tools available to achieve these objectives.

Our aim in recent years, before the crisis emerged, has been to ensure that subsidies are targeted towards horizontal objectives such as these, and to prevent subsidies that merely keep inefficient firms on

life-support. In the mid-1990s, around 50 per cent of government subsidies to industry and services in the EU were earmarked for horizontal objectives as opposed to individual bailouts. By 2008 this figure had risen to nearly 90 per cent.

Overall, government subsidies in the EU amounted to just over 0.5 per cent of EU GDP in the period 2004-2008, excluding measures to address the financial and economic crisis. Over the longer term subsidies are on a downward trend, since they are down from nearly 1 per cent of EU GDP in the 1990s.

The EU system for reviewing State subsidies

What we have in the EU is a system that requires the European Commission to review state subsidies to business and to assess their impact on competition. The fundamental principles were laid down in 1957, as a necessary condition to achieving a common market in goods and services in the EU, and remain unchanged today in the new Lisbon Treaty. A single market across the EU requires a level playing field between businesses in different Member States, so that our review of subsidies looks not only at the impact on competition between businesses in a given country, but also at the impact on cross-border competition.

What we do is essentially carry out a balancing exercise, weighing up the efficiency and equity benefits that are expected to result from a subsidy, against the negative effects the subsidy might have on competition in the EU and on trade between EU Member States.

Specifically we consider whether the government's objective in providing the subsidy does not run counter to the common interest of EU Member States – including growth, employment, regional development, the environment, or research and development.

One element we take into account is whether the subsidy addresses a market failure. For instance, we recognise that small businesses find it difficult to access risk capital because of high transaction costs to assess small projects compared to the expected gains from investment. So subsidies to facilitate access to risk capital may be acceptable. Similarly, we are happy to encourage subsidies for the extension of broadband to remote regions, which is not profitable under normal market circumstances. Likewise, we allow subsidies to cover part of the costs of a research project knowing that markets are not always ready to take on the full risk of research especially when profitability horizon is very long.

We check that, in practice, the subsidy will help achieve that objective, that it creates the right incentives for companies to adjust their behaviour. We also check that the subsidy is proportionate, i.e. that the same adjustments to company behaviour could not be obtained with lower subsidy.

This balancing exercise, based on an economic assessment of the impact of the measure, is carried out before the subsidy is implemented. It can lead to the Commission imposing conditions to minimise the distortion of competition, for instance, a reduction in the amount of the subsidy. This helps ensure that subsidy measures do not have an unduly distortive effect on competition in the EU. It also gives Member States an insight into the effectiveness of a planned subsidy and whether it will give value for money to the taxpayer.

Of course, what we don't do – thankfully – is review every single subsidy measure adopted by EU Member States. Following recent reforms, far fewer measures require notification to the Commission. Some of them do not distort competition or trade between Member States, others benefit from a general exemption laid down by regulation, or a general scheme (for instance for aid to research and development, development of small businesses, training and the creation of new jobs, etc). The Commission only carries out an in-depth, individual, review of those large subsidies which have the potential to be really harmful to competition. And what I want to do is to make sure our procedures for notification and review are as simple and streamlined as possible, so as to keep the bureaucratic burden to a minimum.

However, where we find that a State subsidy is unlawful – that is it violates our rules for its acceptance - it must be recovered in full. That is the only effective way of remedying the distortion of competition created by the subsidy.

Why it works

I've mentioned before the role of state subsidies in the global financial crisis. Let me come back to this issue.

Early action by the European Commission helped ensure a common approach by Member States to financial sector bail-outs. Member States may have adopted different measures – those which they felt were best suited to their respective market situation – whether guarantee schemes, recapitalisation measures, or impaired asset relief measures, or a mixture of these. But the European Commission required that all of these measures complied with certain fundamental principles – non-discriminatory access to national schemes, subsidies limited to what was necessary, mechanisms to prevent abuse of state support, restructuring measures for certain financial institutions that received large amounts of aid.

This helped keep to a minimum any distortions of competition between banks within and across national borders, and helped preserve the integrity of the EU internal market. It prevented costly and damaging subsidy races between Member States, with each trying to outdo the other in an attempt to prevent business moving away.

Going forward, EU policy on reviewing State subsidies – notably through the restructuring measures being agreed as a condition of approving bank subsidies – is helping rebuild viable financial institutions which are able to carry out the essential function of providing finance to the real economy.

Reviewing subsidies at national, supranational and international level?

Naturally, the EU perspective on the control of subsidies is closely associated with its powers and role as a supranational body, pursuing common EU objectives such as a level playing field for business and the internal market.

But the underlying principle – that subsidies should not unfairly distort competition between businesses so that companies can compete on merit to the benefit of consumers – is equally important at national level and on national markets for goods or services. Creating or supporting a national champion creates domestic casualties too – those companies that are not chosen for government support. Measures to support inward investment may result in obvious rewards – but it may be worth assessing for just how long those measures continue to produce net benefits, in particular if such support is open-ended.

National regimes for reviewing state subsidies do exist – for instance in Spain, my own country, the national competition authority has the power to issue opinions on subsidies granted by the regions or the central government. On the other hand, countries that are candidates to join the EU are required to set up systems for reviewing State subsidies. One of them, Croatia, has a system that mirrors the EU system – with the national competition authority entrusted with the relevant powers. Looking further afield, Russia also has a system of subsidy control and the Mexican competition authority has powers to deliver opinions on the impact of subsidies on inter-State trade.

I believe that there is scope for individual countries outside the EU to consider adopting a system of controlling State subsidies, for the benefit of business environment and quality of public policies

What about the international level?

All of us here today recognise the benefits of open markets and the downsides of protectionism. Subsidies can be an instrument of protectionism, countering the benefits of trade liberalisation. The WTO rules on subsidies for goods can play a role in removing the most harmful subsidies – but no rule can be applied properly without transparency. So I fully endorse the OECD ministerial conclusions of last June which state that government measures to support industry must be transparent and WTO consistent. Transparency helps contain protectionist measures by opening them up to public scrutiny – and helps ensure a level playing field for business in markets across the world.

With this in mind, I welcome the initiative by WTO Director General Pascal Lamy to report quarterly on measures adopted by G20 countries to counter the crisis. This is particularly important since the G20 is leading the drive towards a coordinated route out of the crisis for the world economy. In a move which underlines the importance we attach to transparency, the EU has already introduced this principle and reports regularly on all Member State actions, regardless of their G20 status. The next report will be published in early March. I look forward for other countries to follow that lead.

Conclusion

Let me conclude.

The EU rules on government subsidies are a key element of EU competition policy in that they help maintain a level playing field for business within Member States and across Europe. They have proved their worth in the context of the financial and economic crisis, helping avoid damaging subsidy races between EU Member States and minimising the distortions of competition resulting from large-scale government bail-outs for financial institutions.

But rules on government subsidies are not an exclusive EU issue. They have a place in all competition regimes – whether national, federal, supranational or international. They help maintain the level playing field between businesses implanted within a country, across regions, and across national borders. They help open up markets to international trade. Ultimately, they help governments assess the effectiveness of proposed subsidy measures, and help channel funds to where they are the most necessary and can deliver the most benefit to taxpayers.

MS. THITAPHA WATTANAPRUTTIPAIAN (ASEAN)

1. Imperatives and impulses in co-operation

A historic milestone in regional integration within the ten-member Association of South East Asian Nations (ASEAN) is the “ASEAN Vision 2020” adopted at the ASEAN Summit in Kuala Lumpur, Malaysia, in December 1997. The vision foreshadowed the formation of “a stable, prosperous and highly competitive ASEAN economic region”.

This region was subsequently defined as the ASEAN Economic Community (AEC) at the ASEAN Summit in Bali, Indonesia, in October 2003. The AEC, together with the ASEAN Political-Security Community and the ASEAN Socio-Cultural Community, constitutes the three-pillar ASEAN Community which is to be established in 2020.

The target year for ASEAN Community formation, however, was sped up to 2015 at the ASEAN Summit in Cebu, Philippines, in January 2007, and subsequently a Blueprint for AEC formation was adopted at the ASEAN Summit in Singapore in November 2007. When established, the AEC will transform ten separate economies into a single market and seamless production base, thus enhancing further ASEAN’s role as an efficient and dependable player in the regional and global supply chains. As such, competition policy plays a critical role in the realisation of one key aspect of the AEC, namely a highly competitive economic region.

Meanwhile, globalisation has also opened up new ways and means for ASEAN to engage in intra- as well as extra-regional co-operation in competition policy. There is currently no multilateral treaty on competition although this was one of the four “Singapore issues” raised at the first Ministerial Conference of the World Trade Organisation (WTO) in December 1996.¹

However, competition obligations are variously specified within the WTO framework of agreements.² Nine ASEAN Member States (AMSs) are WTO members (except the Lao People’s Democratic Republic). In addition, ASEAN has entered into free trade agreements (FTAs) with six dialogue partners and one of these FTAs have provisions on competition policy.

¹ The fourth WTO Ministerial Conference launched multilateral trade negotiation on the Doha Development Agenda (DDA) in November 2001. This agenda includes negotiations on the core principles for a multilateral framework on competition policy, the modalities for voluntary co-operation, and support for the development of competition policy in developing countries. However, the Doha Conference decided that a decision on how to proceed with the four “Singapore issues” (namely investment, competition policy, government procurement, and trade facilitation) would be made at the fifth WTO Ministerial Conference in Cancun, Mexico, in September 2003. The Cancun trade talks broke down, mainly over the resistance by many developing countries to engaging in negotiation on the four Singapore issues. Subsequently, the WTO General Council Meeting agreed in July 2004 that trade facilitation would be on the agenda for DDA negotiation. But the remaining three issues would be referred to various WTO Working Groups and would remain outside the DDA negotiation mandate. A WTO Working Group focusing on the interaction between trade and competition has since been set up at the WTO.

² Such obligations are contained, for example, in Articles VIII and IX of General Agreement on Trade in Services; Articles 8 and 40 of the Agreement on Trade-Related Aspects of Intellectual Property Rights; Article 11.1 and 11.3 of the Agreement on Safeguards; Article VI of the Agreement on Anti-dumping, and Article XVII (on state trading enterprises) of the General Agreement on Tariffs and Trade, all dated April 2004.

2. ASEAN approach and focus in intra-regional co-operation

The nature and patterns of ASEAN co-operation at the intra- and extra-regional levels are generally conditioned by the diverse stages of development within ASEAN,³ and by the varying amounts of expertise and other resources available for policy design and implementation among AMSs. In particular, only Indonesia, Singapore, Thailand and Viet Nam have at present economy-wide competition policy and competition regulatory bodies (CRBs).

Cambodia, the Lao PDR and Malaysia intend to introduce nation-wide competition policy and CRBs soon. In the mean time, these three AMSs and the other AMSs (namely Brunei Darussalam, Myanmar and the Philippines) will rely or continue to rely on sector-level policies, regulations and administrative procedures to achieve competition policy objectives in various domestic factor and product markets.

Several AMSs have received considerable technical assistance relating to competition policy from the United States and the European Union Member States, among other sources. Such collaborative assistance provided an impetus for the formation in 2004 of the non-official ASEAN Consultative Forum for Competition. This Forum served as a co-operative network for the exchange of policy experiences, best practices and institutional norms relating to competition policy and CRBs among and between competition-related agencies within and outside ASEAN.

ASEAN co-operation then evolved in August 2007 into the official establishment of the ASEAN Experts Group on Competition (AEGC), which first met in March 2008. This intergovernmental body facilitates the development of competition policy that would meet the needs of AMSs at different stages of economic and institutional development. The AEGC also fosters collaboration and networking among and between agencies concerned with competition both inside and outside ASEAN. AEGC work programmes will evolve in parallel with the wider and deeper development and socialisation of competition policy and CRBs in ASEAN.

The AEGC has agreed to focus, for the next three to five years, on building up competition-related policy and institutional capabilities, and best practices in AMSs. In addition, the AEGC has been developing the “ASEAN Regional Guidelines on Competition Policy” and the “Handbook on Competition Policies and Laws in ASEAN for Businesses”. Both the Guidelines and the Handbook are pioneering activities in this part of the world, and are scheduled for adoption and launching by AMSs in 2010.

Specifically, a series of competition-related capacity building and policy dialogue programmes, with the participation of eminent regional and international professionals and practitioners, have been carried out by the AEGC in close co-operation with ASEAN’s dialogue partners and donors. These programmes focus on investigative, enforcement, outreach and advocacy aspects (including anti-competitive horizontal agreements such as price fixing, bid rigging, market division or customer allocation, etc.); on the priorities, organisation and management of newly established CRBs; and on the design and introduction of, and socialisation to mobilise stakeholders’ support for, competition policy and CRBs.

The Guidelines are a targeted delivery under the AEC Blueprint. It is to serve as a common (but non-binding) reference guide for AMSs as they endeavour to introduce, develop and implement competition policy and law which are customised to the specific legal and economic context of each country. The Guidelines also help to chart the paths for future co-operation to enhance the competitive process in the AMSs.

³ In 2008, for example, gross domestic product per head of population was in the range of US\$ 35,000-38,000 in Brunei Darussalam and Singapore, US\$8,000-4,000 in Malaysia and Thailand, US\$ 2,000 in Indonesia and the Philippines, and US\$ 500-1,000 in Cambodia, Lao PDR, Myanmar and Viet Nam.

The Handbook, also a targeted AEC Blueprint delivery, aims to inform and raise awareness of the business community and domestic and external investors on competition-related approaches, practices and procedures in AMSs. As such, it would facilitate the development of a competition culture in the business community as well as create a favourable environment for the introduction and enforcement of competition policy in individual AMSs and regionally.

ASEAN and the AEGC have received significant donors' collaboration and support, both technical and financial, in all those efforts at capacity building, information dissemination and socialisation, and formation of intra- and extra regional linkages. A multi-year regional programme, for instance, has been developed and implemented with support from Germany through InWent (Capacity Building International), and another multi-year programme is currently under design for implementation with support from Germany through German Technical Co-operation (GTZ).

Other sources of technical assistance on a regional basis include the Asian Development Bank Institute, ASEAN-Australia Development Co-operation Programme, the European Commission, Japan (Fair Trade Commission), OECD, and the United States (Department of Justice and the Federal Trade Commission).

3. ASEAN approach and focus in extra-regional co-operation

Compared to other regional economic groupings, ASEAN is a late comer to FTAs. Thus far, ASEAN has signed FTAs with Australia and New Zealand, China, India, Japan and Republic of Korea. ASEAN and the European Union have been negotiating an FTA since May 2007 although progress to date has been much slower than expected.

The approach and architecture of ASEAN FTAs have some innovative features. Firstly, ASEAN FTAs with East and South Asian dialogue partners are governed by the respective bilateral Framework Agreements signed with China in November 2002, India in October 2003, Japan in October 2003, and Republic of Korea in December 2005. There are no provisions in these Framework Agreements for FTAs in competition policy or government procurement. Instead, competition policy is one of the areas reserved for mutual co-operation and facilitation between ASEAN and India and Japan.

Two, the Framework Agreements with East Asian countries have been completed sequentially FTA by FTA. ASEAN and China signed an FTA on goods in November 2004, services in January 2007 and investment in August 2009. Likewise, FTAs in goods (December 2005), services (November 2007), and investment (June 2009) were signed by ASEAN and Republic of Korea. The ASEAN-Japan FTA (signed in April 2008) is comprehensive in scope but the large bulk of this agreement concerns trade in goods. To date, however, ASEAN and India has signed only an FTA on goods (August 2009).

Three, the FTA between ASEAN and Australia plus New Zealand (ANZ), signed in February 2009, follows a different approach. It is comprehensive in scope and was concluded as a "single undertaking" (and not sequentially building brick by building brick). In addition, there is chapter 14 on "Competition", with four provisions, although government procurement is not within the scope of the ASEAN-ANZ FTA. This chapter, however, does not contain any substantive provisions on competition policy.

Specifically, Article 1.1 reaffirms the promotion of competition, economic efficiency and consumer welfare, and the curtailment of anti-competitive practices, as one of the basic principles of competition policy. However, it is also recognised that partner countries have different capacities in competition policy (Article 1.2), and they are free to develop, set, administer and enforce their own competition laws and policies (Article 1.3). Equally important, partner countries are free to develop measures to address anticompetitive practices or to adopt their own policies, for example, to promote domestic economic development (Article 1.4).

The remaining three articles in chapter 14 of the ASEAN-ANZ FTA relate to a range of measures for technical co-operation and facilitation between the FTA partners in various competition-related matters.⁴ Notably in addition, Article 4 of this chapter specifies that Chapter 17 on “Consultations and Dispute Settlement” does not apply to any matter arising under chapter 14 on “Competition”

4. Going forward: Challenges and opportunities ahead

Business competition and consumer interests have been significantly impacted by the increasingly dynamic, an innovative and interlinked global economy, and by the changing operational models in technology, commerce and industry across the value chain. A case in point is the on-going business consolidation and integration for more secured supplies and market access, and for greater scale economies, productivity and competitiveness.

As such, the design, implementation, review and re-prioritising of competition policy as well as the roles and functions of CRBs have become much more complicated and multi-dimensional in nature. A compounding factor is that government everywhere has worn several hats, and policy tensions and conflicts are inevitable at the interface between different policy domains (e.g., competition policy and intellectual property rights, and consumer protection, and industrial development policy, etc.).⁵

Clearly, the early movers have gained a variety of useful and proven lessons and insights. These apply not just to the design and development competition policy and CRBs, and the resolution of policy interface difficulties and problems. There are also highly pertinent lessons and insights in ensuring the balanced and effective implementation, functioning and (self) evaluation of competition policy and CRBs for gainful, dynamic, equitable and inclusive change in different technological and industrial contexts.

Equally clearly, many of those lessons and perspectives are of critical relevance to virtually all AMSs which, with an exception or two, are new comers to the fields of competition policy and consumer protection. The ASEAN Secretariat thus stands ready to collaborate and network with donors of competition-related technical assistance and with CRBs regarding policy dialogues and information exchange on policy matters of mutual focus and concern.

⁴ Such mutual collaboration covers programmes and activities for capacity building, awareness promotion and advocacy and for the mutual exchange of policy experience and information (Article 2). The designation of focal points for technical co-operation and information exchange is covered in Article 3.

⁵ Public action includes the regulation of strategic sectors and industries; reform through privatisation, liberalisation and deregulation; the provision of subsidies to business undertakings of national priority; and commercially significant procurement and selling activities. Moreover, governments have to engage often in negotiation of international, plurilateral and bilateral commitments and obligations for compliance by business and industry.

MR. AMADOU DIENG (WAEMU)

The same Article 88 of the Treaty of the West African Economic and Monetary Union (WAEMU/UEMOA) prohibits cartels, abuse of dominant position and state aid that may distort competition in the common market.

This shows that the oversight of state aid occupies a significant place in WAEMU's competition policy.

It is clear that this oversight can play an important role in regional construction in the light of the many imbalances that public intervention generates within the Union.

In this regard, it should be recalled that the WAEMU rose from the ashes of the West African Economic Community (WEAC/CEAO), which in its last days was marked by a strong trend towards reintroducing tariffs and implementing domestic policies heavily geared towards protecting domestic industries that received considerable tax and financial benefits.

It was also during this period that investment codes were introduced and free industrial zones were created in order to promote foreign investment as a solution to the inadequate level of domestic savings.

The inconclusive results of these choices were among the reasons for the new directions taken and for reactivating a project to build a common market between the member states of the West African Economic and Monetary Union (WAEMU), strongly characterised by its supranational dimension, with its corollary of a transfer of sovereignty.

Regarding the application of a competition code, three major principles have been established by the Union's authorities:

- To ensure that Community interests and rules take precedence over all other considerations;
- To develop the solidarity of national economies;
- To make the system credible both inside and outside the common market, in particular to foreign investors who may be interested in the WAEMU market.

In this perspective, two categories of public intervention are targeted by the Union's regulations:

- Anti-competitive practices engaged in by states (the fact that these are defined in the regulations on competition is an original feature of the WAEMU system); these regulation target public measures that restrict free competition, even if they are not of a financial nature (setting of quotas in intra-Community trade, granting special rights to national companies, adopting restrictive standards, imposing discriminatory administrative formalities, etc.);
- "State aid which might distort free competition by favouring certain companies or the production of certain goods".

For this last category, a review procedure has been established by Regulation 04/2002/CM/UEMOA on the oversight of state aid, which distinguishes between existing aid and new aid, which is the same classification found in the regulations of the European Union.

One of the most significant lessons learned in the brief experience of applying these rules is that, at the current stage, much of state aid is of a structural nature and calling it into question constitutes a major shift to which the national authorities and the benefitting companies find it difficult to adapt.

This is because the oversight system established requires the states to reassess all the financial benefits that they have granted to companies under their national investment codes, mining codes and special establishment agreements.

1. An overview of the regulations

Regulation 04/2002/CM of 23 May 2002 on the oversight of state aid defines this aid as follows: “any measure that (1) generates a direct or indirect cost, or a decrease in revenues for the state, its departments or for any public or private body that the state establishes or designates to manage the aid and (2) thereby gives an advantage to certain companies or to the production of certain goods”.

A procedure to examine any of the different kinds of state aid can be initiated in three circumstances:

- When the notification of aid is filed with the Commission, which is mandatory for all categories of aid;
- When the periodic review of authorised aid is conducted, at the initiative of the Commission;
- When a company or a state files a complaint regarding an illegal form of aid, i.e. one implemented without prior notification of the Commission.

Regulation 04/2002/CM of 23 May 2002 gives a list of the types of aid automatically recognised as being compatible with the common market, without there being any need to examine them, namely:

- Aid of a social nature granted to individual consumers, provided that it is granted without discrimination regarding the origin of the products;
- Aid intended to remedy the damage caused by natural catastrophes or other exceptional occurrences;
- Aid intended to promote the carrying out of an important project of common interest or to remedy a serious disturbance in the economy of a member state;
- Aid connected with research activities conducted by companies or higher education or research institutions that have signed contracts with private companies;
- Aid aimed at promoting the adaptation of existing facilities to new environmental requirements imposed by legislation that lead to greater constraints and a larger financial burden for companies;
- Aid aimed at promoting a country’s culture and the preservation of its heritage, when it does not restrict competition in a significant part of the common market.

Similarly, Regulation 04/2002/CM of 23 May 2002 gives a list of the types of aid automatically recognised as being incompatible with the common market, without there being any need to examine them, namely:

- Aid that is contingent, in law or in fact, whether solely or as one of several other conditions, upon exporting to other member states;
- Aid that is contingent, whether solely or as one of several other conditions, upon the use of domestic goods over goods imported from other member states.

Notified aid may only be granted following a decision by the Commission authorising it or following expiration of the deadline after which this authorisation shall be deemed to have been granted.

If the aid is illegal, the Commission may order the suspension of its payment and the provisional recovery of the aid.

2. Examples of cases handled in WAEMU

Since the competition regulations entered into force, the Commission has more frequently examined cases involving public intervention that could cause market distortions than those involving cartels and abuse of dominant position.

2.1 Cement sector

In the cement sector, the following three cases have been or are currently being addressed by the WAEMU Commission or the Court of Justice.

2.1.1 The case of Ciments du TOGO SA vs. the Commission (September 2000)

On 15 June 2000, the Company CIMENTS du TOGO filed a complaint with the Commission denouncing the preferential treatment that the State of Togo was giving to its competitor, the company WACEM based in the free industrial zone, which was marketing a product within the Union that was not subject to the required customs taxation.

A substantive decision was not made on this case because the Commission held that it did not have jurisdiction to examine the complaint, and the Court of Justice, to which the case was referred, dismissed the case on procedural grounds.

However, the interest of this case lies less in the decision reached than in the substance of the dispute.

In fact, in this case it was entire philosophy of the free industrial zones as they function in the WAEMU that the Community authorities were asked to examine.

The principle of a free industrial zone is that the authorised companies have extraterritorial status that allows them to import, free from duties and taxes, their inputs and capital goods. They are also exempted from a substantial share of their domestic taxes.

In return, the products manufactured in the free zone must be made for export to third countries.

This type of system should not create difficulties regarding the functioning of competition in the domestic market as long as the totality of production is exported.

However, by derogation, the member states that have free zones have allowed 20% of this production to be sold on the domestic market after the duties and taxes applicable to similar products from third countries have been paid.

In this situation, the following problems need to be solved:

- How to correct the imbalances between the production costs of goods manufactured in a free zone and the production costs of goods manufactured under normal conditions, since the former have received exemptions on inputs, manufacturing equipment and certain domestic taxes?
- What are the market shares of the 20% of production in a free zone authorised for sale on the domestic market?
- What reliable mechanism can be used to monitor compliance with the authorised percentages to avoid exceeding the quantities authorised for sale on the domestic market?

The WAEMU Commission may not have been able to answer these questions at the time of this case since Regulation 04/2002/CM/UEMOA of 23 May on the oversight of public aid had not yet been adopted.

Nevertheless, the fact remains that this case called for defining a fundamental position, as it clearly involved a distortion of competition as a result of public aid.

2.1.2 The Case of SOCO CIM vs. the State of Senegal and CIMENTS du Sahel (April 2003)

The company SOCO CIM INDUSTRIES filed a complaint with the Commission regarding dysfunctions in the cement market related to the implementation of a mining agreement between the State of Senegal and the company “LES CIMENTS DU SAHEL”, its competitor.

The Commission’s investigation of this complaint showed that tax exemptions had been granted to the company CIMENTS du SAHEL, which thereby gained a significant competitive advantage over SOCO CIM.

In his comments, the Minister for Economic and Financial Affairs of Senegal argued that the agreement strictly applied the provisions of the WAEMU Community Mining Code, which upholds the validity of all the mining agreements currently in force in the member states during a transitional period.

Even though this was a strong legal argument, the difference in the treatment of the two cement companies was so great that the Commission did not follow it.

In the cement sector, a distinction is made between complete and incomplete cement companies.

A complete cement company is one whose activities range from the extraction of limestone and its processing into clinker to the packaging of the finished cement in bags. The most important stage in the chain ends with the production of clinker, which accounts for approximately 80% of the value added in the overall process.

In incomplete cement companies, the chain extends from the grinding of the clinker to the packaging of the finished cement in bags.

In the case examined by the Commission, the competing companies, although they both theoretically had identical production systems, were not governed by the same types of agreements with the government.

Thus, the company “les Ciments du Sahel”, under the guise of a mining agreement, received exemptions on all of its imports of entrants, capital goods and operating equipment, while SOCOCIM only received a tax reduction on a portion of these components, since it had a less favourable agreement both in terms of its duration and the scope of the benefits.

This gave the company “les CEMENTS du Sahel”, during its start-up phase, the opportunity to import tax-exempt limestone, gypsum and fuel in order to manufacture cement as an incomplete cement producer. The difference in its costs enabled it to market a less expensive product.

Despite the potential beneficial effects on the market, such as greater supply and lower consumer prices, the Commission prohibited the continued granting of the exemptions for the following reasons:

- The competitor receiving the benefits, CEMENTS du SAHEL, could not show that it had attained the same levels of investment as SOCOCIM, which had preceded it in this sector by at least 30 years; this seriously jeopardised the current balance of the market;
- The exemptions on clinker were more favourable to competing imports, to the detriment of production originating within the Union;
- The activities of SOCOCIM, which had a market share of at least 60%, might be abnormally affected due to the unfair competition generated by the State of Senegal.

The conclusions that can be drawn from the Commission’s position are, *inter alia*, the following:

- Absolute priority was given to the rules of competition in this case, since the Commission ruled against the application of the Community Mining Code, which had been established by a text on a par with and subsequent to Regulation 04/2002/CM/UEMOA on oversight of public aid;
- The solution chosen is significant in a field in which the agreements signed between countries and mining companies can last 15 to 20 years or longer, with clauses that can lead to the market being closed to new investors who might bring technological improvements in the sectors involved;
- The adverse effect on intra-Community trade was not focused on particularly as a criterion for analysing the prohibited state aid, but the Commission could also have referred to it since the cement manufactured in Senegal is sold in certain countries of the WAEMU zone, where it is competing with other cements produced in the zone;
- The Commission did not decide that the aid should be recovered, even though very large amounts were involved;
- As this was the first case of illegal aid examined by the Commission, this decision is understandable, as it was meant to be instructive.

2.1.3 *The Case of RUFSAAC vs. the State of Senegal*

A third case in the cement sector is currently being dealt with by the Commission, which must decide regarding the effects of mining agreements signed with Senegal’s cement companies on the market for kraft paper bags used to package cement.

In this case, the competition is between bags manufactured locally by an industrial unit specialised in this field, RUFSA, and bags imported by cement factories.

These imports, which are subject to little or no taxation, are less expensive for cement companies, which therefore tend to stop purchasing their supplies from the local manufacturer.

The Commission will have to answer at least two questions:

- In which category should these exemptions be placed, given that not all manufacturers of kraft paper bags are established within the territory of the Union?
- If the Commission were to define these exemptions as state aid, who would be required to return the funds to be recovered?

2.2 The case of West Africa Gas Pipeline Co. (WAPCO) (April 2004)

On 19 April 2004, the states of Benin and Togo notified the Commission about the special taxation scheme that they were planning to apply to the West African Gas Pipeline Company Project.

This project aimed primarily at transporting and distributing gas produced by the companies Chevron, Texaco, Royal Dutch Shell and the Nigeria National Petroleum Company (NNPC), all operating within Nigeria, is being financed by two sources: 79.7% by the multinationals belonging to the consortium and 20.3% by public entities of Ghana, Benin and Togo.

The arguments used by the notifiers to justify the taxation measures were essentially the following:

- The major benefits that the states participating in the project might reap in terms of the regular supply of gas for industrial use;
- The Community interest of the project, which will ensure greater energy independence for two WAEMU member states by providing a regular supply of gas;
- The high costs of the project, which none of the member states could finance alone;
- Uncertainty about the profitability of the project, particularly in its start-up phase, which implies the need to reduce the operating costs of the companies responsible for operating the pipeline.

After consulting with all the member states, the Commission decided that it had no objection to implementation of the special taxation notified.

However, it did not agree with the applicants regarding the duration of the authorisation requested, specifying that it should be reviewed in 5 rather than 20 years, as the consortium members had requested.

Comment:

1) In this case, all the conditions were met to enable the Commission to give a favourable opinion, in particular the benefits that the Community as a whole could derive from the project. In fact, at the time when the project was initiated, both Benin and Togo had a very high energy deficit that it was vital to correct. Similarly, the prospects for extending the pipeline to Ivory Coast were also a significant factor in the analysis.

2) In general, in the field of public-private partnership for building infrastructure or other projects requiring large amounts of capital, as in the field of privatisations, the Commission will monitor the agreements signed among member states and concession holders, since these agreements may generate more public aid than is required or create rent-seeking situations that hinder competition.

3. Conclusion

The different cases presented have not concerned economic contingency measures, but this does not mean that the member states have not taken steps to address situations such as the rise in prices caused by the crisis.

The support provided to companies has been short-term in most cases and has not raised any particular difficulties regarding competition, except for the flour and food oil sectors, in which complaints have just been filed with the Commission.

However, it should be noted in this regard that the member states have not complied with the requirement to notify the Commission of the measures that they have taken.

This tendency is not limited only to the current economic situation, but is characteristic of the application of the rules for monitoring public intervention within our states, where the culture of supranational governance has not yet sufficiently taken hold. This explains the efforts being made by Commission to conduct an annual census of the existing aid.

Nevertheless, the initiatives taken by private companies, which are increasingly willing to file complaints with the Commission so that it can examine public measures that they consider contrary to Community rules, are doing much to strengthen the regional framework. And it is no exaggeration to say that the work of monitoring state aid is playing a key role in the construction of the WAEMU common market, given the barriers to intra-Community trade that it can help to eliminate.

M. AMADOU DIENG (UEMOA)

Le même article 88 du Traité de l'Union Économique et Monétaire Ouest Africaine prévoit les interdictions concernant les ententes, les abus de position dominante ainsi que les aides publiques susceptibles de fausser la concurrence au sein du Marché commun.

C'est dire que le contrôle des aides publiques occupe une place significative dans la politique de concurrence de l'UEMOA.

On peut comprendre le rôle important qu'il peut jouer dans la construction régionale, au regard des nombreux déséquilibres qu'engendrent les interventions publiques au sein de l'Union.

En effet, l'UEMOA est née des cendres de la Communauté Économique de l'Afrique de l'Ouest (CEAO) dont les derniers moments ont été marqués par un fort courant de réarmement tarifaire et la mise en œuvre de politiques intérieures résolument tournées vers la protection d'industries nationales bénéficiant d'avantages fiscaux et financiers considérables .

Durant cette période également se sont signalés les codes d'investissements et la création de zones franches industrielles destinés à promouvoir l'investissement étranger, comme remède à l'insuffisance de l'épargne intérieure.

Les résultats peu concluants de ces choix ont été parmi les motivations des nouvelles orientations prises, pour la relance d'un projet de construction d'un marché commun entre les États membres de l'Union Économique et Monétaire Ouest Africaine (UEMOA) marquée par une forte affirmation de la supranationalité, avec son corollaire le transfert de souveraineté.

Concernant l'application d'un code de concurrence trois principes majeurs sont fixés par les autorités de l'Union :

- Faire prévaloir les intérêts et règles communautaires sur toutes autres considérations.
- Développer la solidarité des économies nationales.
- Rendre crédible le dispositif aussi bien au niveau interne que vis-à-vis de l'extérieur, en particulier des investisseurs étrangers susceptibles de s'intéresser au marché de l'UEMOA.

Dans ces perspectives deux catégories d'interventions publiques sont visées par la réglementation de l'Union :

- les pratiques anticoncurrentielles imputables aux États dont la définition dans le cadre de la réglementation sur la concurrence est une originalité du dispositif de l'UEMOA ; elles visent les mesures publiques entravant la libre concurrence, sans pour autant avoir un caractère financier (fixation de quotas dans les échanges intracommunautaires, octroi de droits spéciaux à des entreprises nationales, adoption de normes restrictives, imposition de formalités administratives discriminatoires etc.) ;
- "les aides publiques susceptibles de fausser la libre concurrence, en favorisant certaines entreprises ou certaines productions".

Pour cette dernière catégorie, une procédure d'examen est instituée par le Règlement 04/2002/CM/UEMOA relatif au contrôle des aides publiques qui distingue les aides existantes et les aides nouvelles, comme on peut retrouver cette classification dans la réglementation de l'Union Européenne.

L'un des enseignements les plus significatifs de la courte expérience de l'application de ces règles est qu'au stade actuel, les aides publiques sont en bonne partie d'ordre structurel et que leur remise en cause constitue un bouleversement auquel les autorités nationales et les entreprises bénéficiaires s'adaptent difficilement.

En effet, le système de contrôle mis en place impose aux États de reconsidérer tous les avantages financiers qu'ils ont accordés à des entreprises, en application de leurs codes nationaux d'investissement, de codes miniers ou des conventions spéciales d'établissement.

1. Aperçu sur la réglementation

Le Règlement 04/2002/CM du 23 mai 2002 relatif au contrôle des aides publiques en donne la définition suivante : « toute mesure qui (1) entraîne un coût direct ou indirect, une diminution des recettes, pour l'État, ses démembrements ou pour tout organisme public ou privé que l'État institue ou désigne en vue de gérer l'aide et (2) confère ainsi un avantage sur certaines entreprises ou productions »

Trois circonstances peuvent déclencher une procédure examen des différentes aides publiques :

- La notification des aides à la Commission qui est obligatoire pour toutes les catégories d'aides.
- La revue périodique des aides autorisées, à l'initiative de la Commission.
- La plainte d'une entreprise ou d'un État contre une aide illégale, c'est-à-dire mise en œuvre sans notification préalable à la Commission.

Le Règlement 04/2002/CM du 23 mai 2002 donne une liste d'aides reconnues d'office compatibles avec le marché commun, sans qu'il soit besoin de les examiner, à savoir :

- Les aides à caractère social octroyées aux consommateurs individuels, à condition qu'elles soient octroyées sans discrimination liée à l'origine des produits.
- Les aides destinées à remédier aux dommages causés par les calamités naturelles ou d'autres événements extraordinaires.
- Les aides destinées à promouvoir la réalisation d'un projet important d'intérêt communautaire ou à remédier à une perturbation grave de l'économie d'un État membre.
- Les aides liées à des activités de recherche menées par des entreprises ou par des établissements d'enseignement supérieur ou de recherche ayant signé des contrats avec des entreprises privées.
- Les aides visant à promouvoir l'adaptation d'installations existantes à de nouvelles prescriptions environnementales imposées par la législation qui se traduisent pour les entreprises par des contraintes plus importantes et une charge financière plus lourde.
- Les aides destinées à promouvoir la culture et la conservation du patrimoine, quand elles ne restreignent pas la concurrence dans une partie significative du Marché commun.

De la même manière, le Règlement 04/2002/CM du 23 mai 2002 donne une liste d'aides reconnues d'office incompatibles avec le Marché commun, sans qu'il soit besoin des les examiner :

- Les aides subordonnées, en droit ou en fait, soit exclusivement, soit parmi d'autres conditions aux résultats à l'exportation vers les autres États membres.
- Les aides subordonnées soit exclusivement, soit parmi d'autres conditions à l'utilisation de produits nationaux de préférence à des produits importés des autres États membres.

Une aide notifiée ne peut être exécutée qu'après une décision de la Commission l'autorisant ou à l'expiration du délai au bout duquel cette autorisation est réputée être donnée.

Dans le cas d'une aide illégale, la Commission peut ordonner la suspension de son versement et à titre provisoire sa récupération.

2. Exemples de cas traités dans l'UEMOA

Depuis l'entrée en vigueur des textes sur la concurrence, les affaires examinées par la Commission qui se rapportent à des interventions publiques susceptibles d'occasionner des distorsions sur le marché sont plus fréquentes que celles portant sur les ententes et les abus de position dominante

2.1 Secteur du ciment

Dans le secteur du ciment les trois cas suivants ont été traités ou en cours de traitement par la Commission de l'UEMOA ou la Cour de Justice.

2.1.1 L'affaire les Ciments du TOGO SA contre la Commission (septembre 2000) :

Le 15 juin 2000, la Société les CIMENTS du TOGO a introduit une demande auprès de la Commission dénonçant le traitement de faveur accordé par l'État du Togo à sa concurrente, l'entreprise WACEM installée dans la Zone franche industrielle qui met sur le marché de l'Union un produit ne supportant pas la fiscalité douanière requise.

Une décision sur le fond n'a pas été rendue dans cette affaire puisque la Commission s'était déclarée incompétente, pour examiner la demande et la Cour de Justice saisie a rejeté le recours pour vice de forme.

Toutefois, l'intérêt de cette affaire réside moins dans la décision issue de la procédure que dans le fond du litige.

En effet c'est toute la philosophie des zones franches industrielles telles qu'elles fonctionnent dans la zone UEMOA que les autorités communautaires étaient invitées à examiner.

Le principe de la zone franche industrielle est que les entreprises qui y sont agréées bénéficient d'un statut d'extraterritorialité leur permettant d'importer, en franchise des droits et taxes, leurs intrants et leurs biens d'équipement. Une bonne partie des impôts intérieurs leur sont également dispensés.

En contrepartie, les produits fabriqués en zone franche doivent être destinés à l'exportation vers des pays tiers.

Le système ainsi conçu ne devrait pas poser de difficultés sur le fonctionnement de la concurrence au sein du marché intérieur tant que l'intégralité de la production réalisée est exportée.

Or par dérogation, les États membres abritant des zones franches, ont admis que 20% de cette production puisse être vendue sur le marché intérieur, après avoir acquitté les droits et taxes applicables aux produits similaires venant de pays tiers.

A partir de ce moment, il s'agit de résoudre les problèmes suivants :

- comment corriger les déséquilibres entre les coûts de production des marchandises fabriquées en Zone franche et les coûts de production des marchandises fabriquées en régime normal, les premières ayant bénéficié d'exonérations sur les intrants, le matériel de fabrication et certains impôts intérieurs ;
- quelles parts de marché peuvent représenter les 20% de la production réalisée en zone franche et admise à être vendue sur le marché intérieur ;
- par quel mécanisme fiable sera contrôlé le respect des pourcentages autorisés, pour éviter un dépassement des quantités autorisées à être mises sur le marché intérieur.

Peut être que la Commission de l'UEMOA n'a pas pu donner de réponse à ces questions au moment où elle a été saisie, du fait que le Règlement 04/2002/CM/UEMOA du 23 mai relatif au contrôle des aides publiques n'était pas encore adopté.

Cependant, il reste constant qu'une position de principe était nécessaire dans cette affaire, car il y a manifestement distorsion de concurrence due à des aides publiques.

2.1.2 *Affaire SOCOCIM contre État du Sénégal et CIMENTS du Sahel (Avril 2003)*

Se plaignant de dysfonctionnements dans le marché du ciment, liés à la mise en œuvre d'une convention minière entre l'État du Sénégal et la Société "LES CIMENTS DU SAHEL" sa concurrente, la Société SOCOCIM INDUSTRIES en a saisi la Commission.

L'enquête menée par la Commission suite à cette saisine a fait ressortir l'application d'exonérations fiscales accordées à l'entreprise les CIMENTS du SAHEL qui bénéficie ainsi d'un avantage concurrentiel important sur la SOCOCIM.

Dans ses observations, le Ministre de l'Économie et des Finances du Sénégal a fait valoir l'application stricte des dispositions du Code minier communautaire de l'UEMOA qui, à titre transitoire, maintient en vigueur toutes les conventions minières en cours dans les États membres.

Bien que cet argument de droit ait été fort, l'ampleur du déséquilibre dans le traitement réservé aux deux cimenteries était tellement importante que la Commission ne l'a pas suivi.

Dans le secteur du ciment, on distingue les cimenteries complètes et les cimenteries incomplètes.

La cimenterie complète est celle qui incorpore les activités allant de l'extraction du calcaire, de sa transformation en clinker jusqu'à la mise en sac du ciment fini. L'étape la plus importante dans la chaîne s'arrête à la production de clinker qui absorbe environ 80% de la valeur ajoutée dans l'ensemble du processus.

Dans les cimenteries incomplètes, la chaîne part du broyage du clinker jusqu'à l'ensachage du ciment fini.

Dans le cas examiné par la Commission les entreprises en compétition, bien que présentant théoriquement toutes les deux des schémas de production identique, n'étaient pas régies par les mêmes types de conventions avec l'État.

Ainsi la Société « les Ciments du Sahel », sous le couvert d'une convention minière, bénéficiait d'exonérations sur l'ensemble de ses importations d'intrants, des biens d'équipement et du matériel d'exploitation, tandis que la SOCOCIM ne pouvait prétendre qu'à une fiscalité réduite sur une partie de ces

éléments, étant dans le régime d'une convention moins favorable en durée et en champ de couverture des avantages.

Cela s'est traduit par la possibilité qui a été offerte à l'entreprise « les CEMENTS du Sahel », durant sa phase de démarrage, d'importer du calcaire, du gypse et du fuel exonérés pour faire du ciment, en mode cimenterie incomplète. La différence des coûts supportés lui permettait ainsi de proposer un produit moins cher.

Bien que cela ait pu avoir des effets bénéfiques sur le marché, notamment l'augmentation de l'offre et la baisse des prix à la consommation, la Commission a interdit la poursuite de l'application des exonérations en cause pour les raisons suivantes :

- le concurrent avantage, les CEMENTS du SAHEL, ne justifiait pas avoir atteint les mêmes niveaux d'investissement que la SOCOCIM qui l'a précédé dans le secteur d'au moins trente ans. Ce qui rendait très aléatoire les équilibres du marché affichés ;
- les exonérations sur le clinker favorisaient davantage les importations concurrentes au détriment de la production originaire de l'Union ;
- les activités de la SOCOCIM qui occupait au moins 60% de part de marché risquaient d'être anormalement affectées du fait d'une mauvaise concurrence entretenue par l'État du Sénégal.

Les enseignements à tirer de la position de la Commission, entre autres, sont les suivants :

- La primauté accordée aux règles de concurrence a été absolue dans cette affaire, pour que la Commission puisse écarter l'application du Code Minier Communautaire qui a été institué par un texte de même rang et postérieur au Règlement 04/2002/CM/UEMOA relatif au contrôle des aides publiques.
- La solution retenue est d'importance dans un domaine où les conventions signées entre les États et les entreprises minières peuvent avoir des durées de 15 à 20 ans ou plus avec des clauses pouvant entraîner la fermeture du marché à de nouveaux investisseurs susceptibles d'apporter des améliorations technologiques dans les secteurs concernés.
- L'affectation des échanges intracommunautaires n'a pas été particulièrement retenue comme critère d'analyse des aides publiques interdites, mais pouvait également être évoqué par la Commission dans la mesure où le ciment fabriqué au Sénégal est vendu dans certains pays de la zone UEMOA ou il fait concurrence à d'autres ciments produits dans la zone.
- La Commission ne s'est pas non plus prononcée sur la récupération de l'aide qui pourtant se chiffrait à des montants très élevés.
- S'agissant de la première affaire d'aide illégale examinée par la Commission, on peut comprendre ce choix qui se veut pédagogique.

2.1.3 *Affaire RUFSA contre État du Sénégal*

Une troisième affaire dans le secteur du ciment est en cours de traitement par la Commission qui doit se prononcer sur les effets de l'application des conventions minières signées avec les cimenteries du Sénégal sur le marché des sacs en papier kraft destinés à l'emballage du ciment.

Dans ce cas-ci, la concurrence se déroule entre la production locale de sacs fabriqués par une unité industrielle spécialisée dans ce domaine, la RUFSA, et les importations faites par les usines de ciments.

En effet, ces importations, bénéficiant d'une taxation nulle ou réduite, coûtent moins cher aux cimenteries qui de ce fait ont tendance à renoncer à s'approvisionner auprès du fabricant local.

La Commission devra répondre au moins à deux questions :

- Dans quelle catégorie faudrait-il loger les exonérations en cause sachant que les fabricants de sacs en papier kraft ne sont pas tous installés sur le territoire de l'Union.
- Si la Commission devait retenir la qualification d'aides publiques auprès de qui la récupération de cette aide pourrait être exigée.

2.2. *Affaire GAZODUC de l'AFRIQUE de l'Ouest (WAPCO) (Avril 2004)*

Le 19 avril 2004, les États du Bénin et du Togo avaient adressé des notifications à la Commission concernant le projet de fiscalité spéciale qu'ils prévoyaient d'appliquer aux activités du Projet GAZODUC de l'Afrique de l'Ouest (Western African Gas Pipeline Company)

Le financement de ce projet essentiellement centré sur le transport et la distribution de gaz produit par les sociétés Chevron Texaco, Royal Dutch Shell et Nigeria National Petroleum Company (NNPC), opérant toutes en territoire nigérian, est assuré par deux sources : 79,7% par les multinationales membres du consortium et 20,3% par des entités de droit public du Ghana, du Bénin et du Togo.

Les arguments développés par les notifiant pour justifier l'application d'une fiscalité sont essentiellement les suivants :

- Les avantages importants que pouvaient tirer les États parties au projet en termes de régularité de l'approvisionnement en gaz à usage industriel.
- L'intérêt communautaire du projet qui va assurer à deux États membres de l'UEMOA une plus grande indépendance énergétique par un approvisionnement régulier en gaz.
- Les coûts élevés du projet qu'aucun des États membres ne pouvait financer seul.
- L'incertitude de la rentabilité du projet, en particulier dans sa phase de démarrage qui implique la nécessité d'alléger les charges de fonctionnement des entreprises chargées de l'exploitation du gazoduc.

Après consultation de tous les États membres, la Commission a émis une décision de non objection à la mise en œuvre de la fiscalité spéciale notifiée.

Cependant, elle n'a pas suivi les demandeurs sur la durée de l'autorisation sollicitée qu'elle a assortie d'une période de réexamen de 5ans au lieu de 20 ans, tel que demandé par les membres du consortium.

Remarque:

1) *Dans cette affaire toutes les conditions étaient réunies pour permettre à la Commission de donner un avis favorable, en particulier les avantages que l'ensemble de la Communauté pouvait tirer du projet. En effet, au moment où le projet était initié, aussi bien le Bénin que le Togo souffraient d'un déficit énergétique très élevé qu'il était vital de résorber. De même les perspectives d'extension du gazoduc vers la Côte d'Ivoire étaient également un facteur significatif dans l'analyse.*

2) *De façon générale, dans le domaine du partenariat public/privé pour la réalisation d'infrastructures ou d'autres projets mobilisant des capitaux élevés, tout comme dans le domaine des privatisations, la Commission sera amenée à surveiller les conventions signées entre les États membres et les concessionnaires. En effet, ces conventions sont susceptibles d'engendrer des aides publiques au-delà du nécessaire et créer des rentes de situation entravant la concurrence.*

Conclusion

Les différentes affaires exposées n'ont pas concerné des mesures conjoncturelles mais cela ne signifie pas que les États membres n'aient pas été amenés à intervenir pour faire face à des situations telles que le renchérissement des prix du fait de la crise.

Seulement, les soutiens apportés aux entreprises ont été de courte durée dans la plupart des cas et n'ont pas soulevé de difficultés particulières concernant la concurrence, sauf en ce qui concerne le secteur de la farine et celui de l'huile alimentaire pour lesquels des saisines viennent de parvenir à la Commission.

Cependant, il y a à noter, à ce niveau que la notification obligatoire à la Commission des mesures qu'ils ont prises n'a pas été observée par les États membres.

Et ceci, au-delà de la conjoncture, est caractéristique de l'application des règles de contrôle des interventions publiques dans nos États où la culture de la supranationalité n'est pas encore suffisamment ancrée. D'où les efforts fournis par la Commission pour procéder à un recensement annuel des aides.

Toutefois, les initiatives des entreprises privées qui, de plus en plus n'hésitent pas à saisir la Commission pour faire examiner les mesures publiques qu'elles estiment contraires aux règles communautaires, contribuent beaucoup au renforcement du cadre régional. Et il n'est pas exagéré d'affirmer que le chantier du contrôle des aides publiques est au cœur de la construction du marché commun de l'UEMOA, au regard des obstacles aux échanges intracommunautaires qu'il peut aider à lever.

POWERPOINT PRESENTATION BY MR AMADOU DIENG

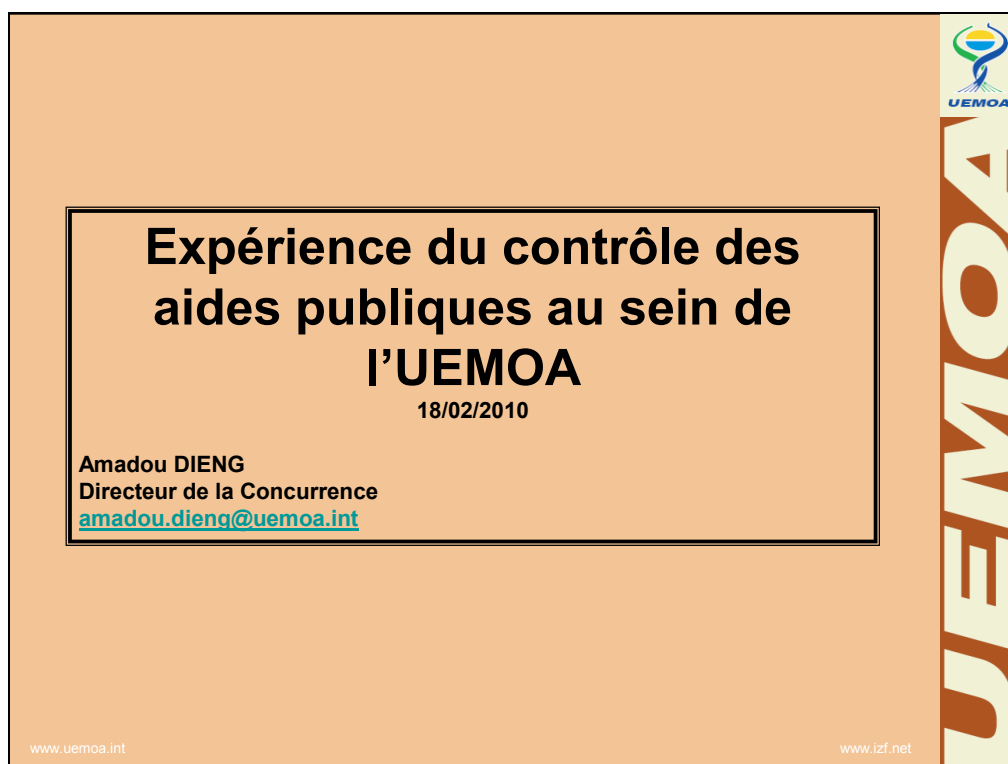

The slide features a light orange background. On the right side, there is a vertical banner with the UEMOA logo at the top and the acronym 'UEMOA' written vertically in large, bold, yellow letters. The main content is enclosed in a black-bordered box. The title 'Expérience du contrôle des aides publiques au sein de l'UEMOA' is centered in bold black text. Below the title is the date '18/02/2010'. The presenter's name 'Amadou DIENG' and title 'Directeur de la Concurrence' are listed, followed by the email address 'amadou.dieng@uemoa.int' in blue. At the bottom left, the website 'www.uemoa.int' is displayed, and at the bottom right, 'www.izf.net' is shown.

**Expérience du contrôle des
aides publiques au sein de
l'UEMOA**

18/02/2010

Amadou DIENG
Directeur de la Concurrence
amadou.dieng@uemoa.int

www.uemoa.int www.izf.net

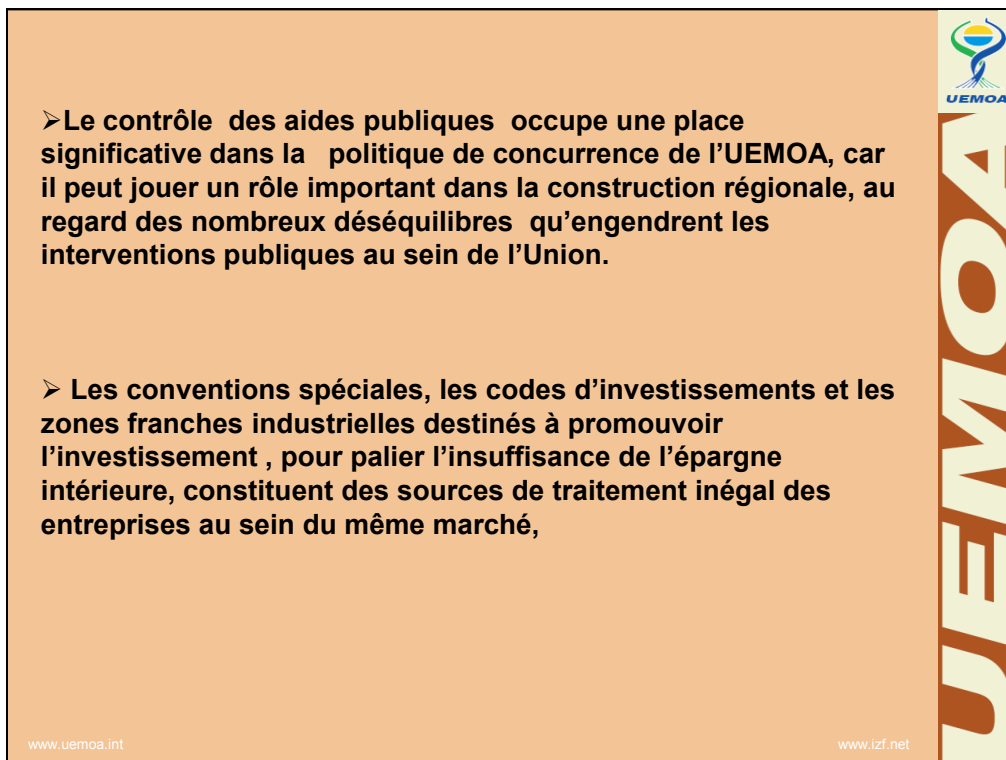

Deux catégories d'interventions publiques sont visées par la réglementation de l'Union :

- **les pratiques anticoncurrentielles imputables aux Etats dont la définition dans le cadre de la réglementation sur la concurrence est une originalité du dispositif de l'UEMOA ; elles visent les mesures publiques entravant la libre concurrence, sans pour autant avoir un caractère financier (fixation de quotas dans les échanges intracommunautaires, octroi de droits spéciaux à des entreprises nationales, adoption de normes restrictives, imposition de formalités administratives discriminatoires etc.),**
- **les aides publiques susceptibles de fausser la libre concurrence, en favorisant certaines entreprises ou certaines productions, et pour lesquelles, une procédure d'examen est instituée par le Règlement 04/2002/CM/UEMOA qui distingue les aides existantes et les aides nouvelles, comme on peut retrouver cette classification dans la réglementation de l'Union Européenne**

www.uemoa.int

www.izf.net



➤ **L'un des enseignements importants de l'expérience de l'application du contrôle des aides publiques au sein de l'UEMOA est que celles-ci sont souvent d'ordre structurel et leur remise en cause constitue un bouleversement auquel les autorités nationales et les entreprises bénéficiaires s'adaptent difficilement.**

➤ **Les trois cas suivants, traités ou en cours de traitement par la Commission de l'UEMOA ou la Cour de Justice dans le secteur du ciment, illustrent bien ce propos. Il en est ainsi aussi du cas du projet de Gazoduc de l'Afrique de l'Ouest,**

➤ **Des aides publiques destinées à faire face à des situations conjoncturelles spécifiques ont été examinées. Seulement aucune décision formelle n'a été retenue les concernant.**

www.uemoa.int

www.izf.net



L'affaire les Ciments du TOGO SA contre la Commission
(septembre 2000)

➤ L'entreprise WACEM installée en zone franche industrielle, bénéficiant d'un statut d'extraterritorialité, arrive à importer, en franchise des droits et taxes, ses intrants et ses biens d'équipement. Une bonne partie des impôts intérieurs lui sont également dispensés.

➤ Sa concurrente les Ciments du TOGO, se plaint des distorsions de concurrence engendrées par le fonctionnement du système qui met en compétition des produits ne bénéficiant pas des mêmes avantages.

➤ Le fonctionnement des zones franches ne devrait pas poser de difficultés sur le fonctionnement de la concurrence au sein du marché intérieur tant que l'intégralité de la production réalisée est exportée. Or par dérogation, il est admis que 20% de cette production puisse être vendue sur le marché intérieur, après avoir acquitté les droits et taxes applicables aux produits similaires venant de pays tiers.

www.uemoa.int

www.izf.net



Affaire SOCOCIM contre Etat du Sénégal et CIMENTS du
Sahel(Avril 2003)

➤ Dysfonctionnements dans le marché du ciment, liés à la mise en œuvre d'une convention minière entre l'Etat du Sénégal et la Société "LES CIMENTS DU SAHEL" sa concurrente, au détriment de la Société SOCOCIM INDUSTRIES.

➤ L'examen de l'affaire a révélé que la Société « les Ciments du Sahel », sous le couvert d'une convention minière, bénéficiait d'exonérations sur l'ensemble de ses importations d'intrants, des biens d'équipement et du matériel d'exploitation, tandis que la SOCOCIM ne pouvait prétendre qu'à une fiscalité réduite sur une partie de ces éléments, étant dans le régime d'une convention moins favorable.

www.uemoa.int

www.izf.net



Les prix du ciment au Sénégal bien qu'ayant baissé dans un premier temps, la Commission a interdit la poursuite de l'application des exonérations en cause pour les raisons suivantes :

- **le concurrent avantageé, les CEMENTS du SAHEL, ne justifiait pas avoir atteint les mêmes niveaux d'investissement que la SOCOCIM qui l'a précédé dans le secteur d'au moins trente ans. Ce qui rendait très aléatoire les équilibres du marché affichés,**
- **les exonérations sur le clinker favorisaient davantage les importations concurrentes au détriment de la production originaire de l'Union,**
- **les activités de la SOCOCIM qui occupait au moins 60% de part de marché risquaient d'être anormalement affectées du fait d'une mauvaise concurrence entretenue par l'Etat du Sénégal.**

www.uemoa.int

www.izf.net



Les enseignements à tirer de la position de la Commission, entre autres, sont les suivants :

- **La primauté accordée aux règles de concurrence a été absolue dans cette affaire, pour que la Commission puisse écarter l'application du Code Minier Communautaire.**
- **La solution retenue est d'importance dans un domaine où les conventions signées entre les Etats et les entreprises minières peuvent avoir des durées de 15 à 20 ans.**
- **L'affectation des échanges intracommunautaires n'a pas été particulièrement retenue comme critère d'analyse des aides publiques interdites.**
- **La Commission ne s'est pas non plus prononcée sur la récupération de l'aide qui pourtant se chiffrait à des montants très élevés.**

www.uemoa.int

www.izf.net



Affaire RUF SAC contre Etat du Sénégal (en cours de traitement)



➤ Distorsions de concurrence entre la production locale de sacs fabriqués par une unité industrielle spécialisée dans ce domaine, la RUF SAC, et les importations faites par les usines de ciments qui bénéficient d'une taxation nulle ou réduite et coûtent ainsi moins cher.

➤ Deux questions se posent à la Commission :

• Dans quelle catégorie faudrait-il loger les exonérations en cause, sachant que les fabricants de sacs en papier kraft ne sont pas tous installés sur le territoire de l'Union?

• Si la Commission devait retenir la qualification d'aides publiques auprès de qui la récupération de cette aide pourrait elle être exigée?

www.uemoa.int

www.izf.net



Affaire GAZODUC de l'AFRIQUE de l'Ouest (WAPCO) (Avril 2004)



➤ Notification à la Commission par le Bénin et le Togo d'une fiscalité spéciale qu'ils prévoyaient d'appliquer aux activités du Projet GAZODUC de l'Afrique de l'Ouest (Western African Gas Pipeline Company)

➤ Le financement du Gazoduc est assuré par deux sources: les sociétés multinationales Chevron Texaco, Royal Dutch Shell et Nigeria National Petroleum Company (NNPC), opérant toutes en territoire nigérian pour 79,7% et par des entités de droit public du Ghana, du Bénin et du Togo pour 20,3%.

www.uemoa.int

www.izf.net



➤ Se basant sur les arguments suivants développés par les notifiant, la commission a émis un avis de non objection :

- les avantages importants que pouvaient tirer les Etats parties au projet en termes de régularité de l’approvisionnement en gaz à usage industriel,
- l’intérêt communautaire du projet qui va assurer à deux Etats membres de l’UEMOA une plus grande indépendance énergétique par un approvisionnement régulier en gaz,
- les coûts élevés du projet qu’aucun des Etats membres ne pouvait financer seul,
- l’incertitude de la rentabilité du projet, en particulier dans sa phase de démarrage qui implique la nécessité d’alléger les charges de fonctionnement des entreprises chargées de l’exploitation du gazoduc,

➤ La Commission n’a pas suivi les demandeurs sur la durée de l’autorisation sollicitée qu’elle a assortie d’une période de réexamen de 5ans au lieu de 20 ans, tel que demandé par les membres du consortium.

UEMOA

www.izf.net

CONCLUSION

➤ Les différentes affaires exposées n’ont pas concerné des mesures conjoncturelles mais cela ne signifie pas que les Etats membres n’aient pas été amenés à intervenir pour faire face à des situations telles que le renchérissement des prix du fait de la crise. Seulement, les soutiens apportés aux entreprises ont été de courte durée dans la plupart des cas et n’ont pas soulevé de difficultés particulières concernant la concurrence, sauf en ce qui concerne le secteur de la farine et celui de l’huile alimentaire pour lesquels des saisines viennent de parvenir à la Commission.

➤ L’absence de notification systématique des projets d’aides publiques par les Etats montre que la culture de la supranationalité n’est pas encore suffisamment ancrée.

➤ Des efforts sont fournis par la Commission pour procéder à un recensement annuel des aides.

UEMOA

www.uemoa.int www.izf.net

PRESENTATION BY MR MICHAEL THONE

FiFo Institute for Public Economics, University of Cologne
Finanzwissenschaftliches Forschungsinstitut an der Universität zu Köln



Subsidy Control for the 21st Century

Achieving Sustainable Competition in the Post-Crisis World

Michael Thöne
Managing Director, FiFo Institute Cologne (Germany)
Global Subsidies Initiative Affiliate

9th Global Forum on Competition
Session 1: Roundtable on Competition, State Aids and Subsidies
OECD Headquarters

18 February 2010

Present and upcoming challenges







- Economic and financial crisis
 - Gave rise to many new subsidies...
 - ...and problems to reduce them afterwards (the “ratchet effect”)
- Global Integration of production and markets
 - Increasing competition for investment / FDI → More Subsidies
 - Increasing political incentive for protectionism → More Subsidies
- Climate change and sustainable development
 - New factors surface which were not considered a problem previously
 - Subsidization of fossil fuels (→ G20 Initiative)
 - Subsidization of biofuels etc.
 - Ultimately: Which competition is to be protected?
 - Traditional competition (focused on *final* goods and services)?
 - Sustainable competition?
 - I.e. fair competition compatible with sustainable development.
 - Is that the “Opening of Pandora’s Box”?

Michael Thöne

2

Subsidy control on the national level





- National subsidy control has multiple goals. Mainly, it is an evaluation whether
 - Policy goals are justified;
 - Instruments are well-designed;
 - Negative impacts minimized;
 - Subsidies are implemented effectively and efficiently (see next slide).
- Protection of competition only to a limited extent – in two dimensions:
 - Spatial bias: By its very nature, focus on competition on the sub-national or national level, not the international level.
 - Power bias: More often than not, independence and/or resources of the body responsible for subsidy control are rather limited.
- Anyhow, very good practice in some countries:
 - Transparency: Switzerland, Germany. Australia (esp. for Tax Expenditures)
 - Across-The-Board Subsidy Audit: Swiss Subsidy Law
 - Systematic In-Depth Evaluation: UK, Germany (esp. for Tax Expenditures)

Michael Thöne

3

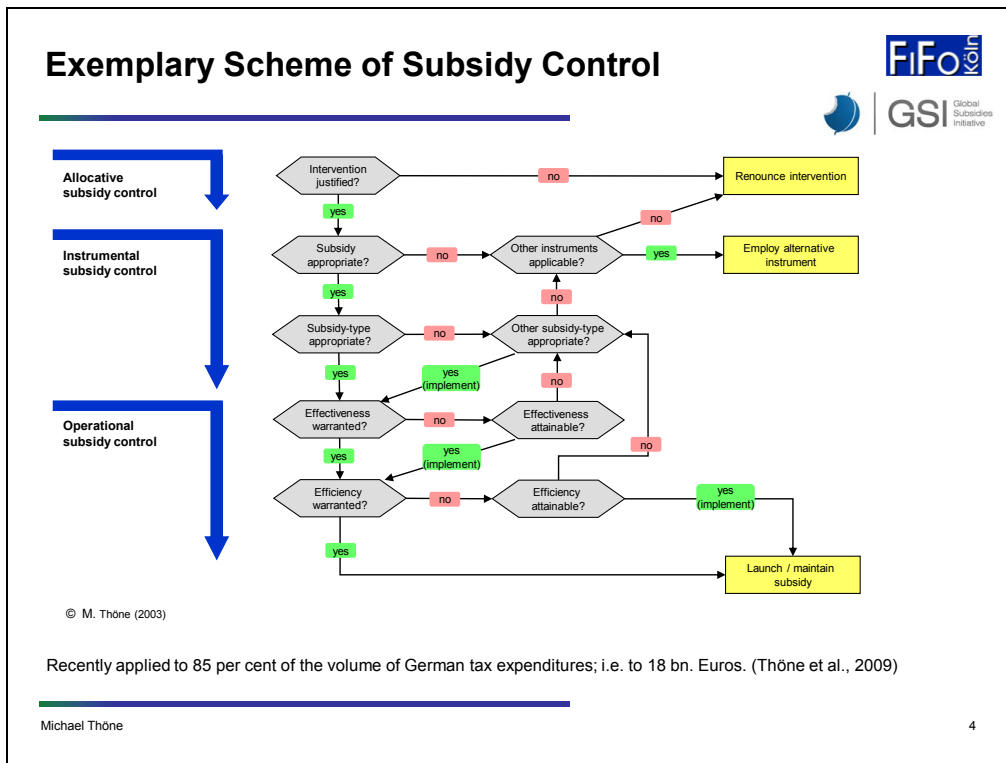

- ### Subsidy control for the transnational level
- Competition turns increasingly regional and global.
 - Protection of competition should follow.
 - Institutional subsidy control on the transnational level (EU Art. 87-88, WTO ASCM)
 - Virtual transnational subsidy control: Granting foreign firm the unrestricted power to sue against subsidies in national courts
 - Strong mandate needed (*effectively* strong)
 - Successful example: EU State Aid Control (...but it took decades)
 - Unsuccessful example: WTO Agreement on Subsidies and Countervailing Measures (good in theory, insufficient power)
 - Factors of Success for regional systems of subsidy control:
 - Strong conviction concerning the mid- and long-term gains from fair competition among similar economies.
 - Broad definition of subsidies (tip: start with WTO definition)
 - Permanent delegation of (judicative) power to the transnational institution
 - Inconsequential willingness to compensate the important losers.
- Michael Thöne 5

Challenges / Open Questions



- Stronger subsidy control produces “sophisticated subsidies”
 - Pressure on direct subsidies increases tax expenditures
 - “Make one private party subsidize the other”: e.g. Feed-in laws
 - Subsidization is pushed into regulation (or the deferral of regulation)
 - These dynamics reinforce the need for a broad and robust mandate.
 - But they also give rise to a new, unsolved problem:
- Successful transnational subsidy control can interfere with other national policy objectives:
 - Example: The Austrian energy excise (CoJ, of 8. 11. 2001 - C-143/ 99)
 - Distortion of *international* competition is asserted whenever *national* law is not implemented uniformly. Even when the objective circumstances of competition on the relevant market point into the opposite direction.
 - This problem becomes *really* pressing in global context.
 - Solution? → Establishment of rules of sustainable competition?

SUMMARY OF DISCUSSION

By the Secretariat

Mr. Frédéric Jenny, Chairman of the Global Forum on Competition, thanked EU Competition Commissioner, Mr. Joaquim Almunia, for his thoughtful keynote speech on the policy of the EU Commission regarding state aids. Mr. Jenny then introduced the Chairman of the first session on *Competition Policy, State Aids and Subsidies*: Mr. Monkid Mestassi, Secretary General of the Ministry of Economics and General Affairs in Morocco.

Mr. Mestassi presented the three experts panellists: Mr. David Spector, Associate Professor at the Paris School of Economics (founder of MAPP, a consultancy specialised in competition economics); Mr. Amadou Dieng, Director for Competition of the West African Economic and Monetary Union Commission (WAEMU); and Mr. Michael Thöne, from the FIFO Institute, affiliated to Global Studies Initiative in Germany.

Mr. David Spector began his intervention by stressing the importance of the issue of state aids and subsidies. State aids still represent a large amount of public funds but control over state aid measures is quite limited outside the European Union. He described the great variety of instruments and recipients as well as the diversity of state aid control rules across countries.

Mr. Spector noted that Commissioner Almunia had largely dealt with the possible economic justifications for state aids. Mr. Spector thus focused his presentation mostly on the various possible harmful effects of state aids. He began by explaining that when assessing the efficiency of an aid, one should take into account the costs of raising public funds and the opportunity cost of state aid measures. The opportunity cost is likely to be high in developing countries, where the return to alternative uses of public funds (such as healthcare or education) is higher than in developed countries.

State aids can also have direct harmful effects. This is first the case for subsidy races which result from a lack of coordination between governments. Second, aids can interfere with market signals, thus creating distortions and entailing productive and allocative inefficiencies. Energy and water subsidies illustrate this phenomenon. Third, when the subsidies objective is merely to keep failing firms afloat, subsidies are likely to yield capital and labour misallocation. Finally, state aids alter firms' incentives because of the "soft budget constraint": firms expecting to be bailed out in case they encounter difficulties, or expecting that their less fortunate rivals will be bailed out if they do less well in the competitive process, have weak incentives to innovate, reduce costs or increase the quality and variety of their offering.

Mr. Spector concurred with Commissioner Almunia who had earlier praised the European Commission's evolution towards a more economic-based approach regarding state aids. Mr. Spector presented the main principles of this approach. It is necessary to identify the actual market failure behind each state aid measure, and to determine whether the aid measure is a proper instrument to correct it. One should also assess whether the aid is the least distortive correcting mechanism.

Mr. Spector concluded by making several recommendations about the future role of competition authorities. In addition to dealing with cases where government agencies engage in anticompetitive behaviour, competition authorities should have an active advisory and advocacy role. They should also throw light on the amounts of unjustified subsidies and on the identity of their recipients. The ensuing increase in transparency could be a powerful tool to make the granting of state aids and subsidies less frequent and better targeted.

The Chairman then gave the floor to the second panel expert, Mr. Amadou Dieng from WAEMU.

Mr. Amadou Dieng first stated that efficient control over state aids and subsidies was an essential instrument to consolidate the common market in the West African Economic and Monetary Union (comprising eight West African countries). Due to insufficient public savings, these countries are in a dire need of foreign investment and are thus encouraged to grant aids that often distort competition between the Member States.

Mr. Dieng then commented on an important case highlighting the difficulties that the WAEMU Commission had been encountering in enforcing state aid rules. This illegal aid case was the first one dealt with by the Commission. It involved two cement manufacturers, SOCO CIM and the Ciments du Sahel. SOCO CIM had been operating in Senegal for 30 years, but the Senegalese government considered that the supply of cement remained insufficient. It had therefore granted tax exemptions to the Ciments du Sahel, which thereby gained a significant competitive advantage over SOCO CIM.

The Commission had prohibited the scheme because of the distortion of competition it entailed. Mr. Dieng stressed that this decision was an important achievement for the Commission. However, he would have wished the Commission being able to impose the recovery of the aid.

The Chairman then gave the floor to the third panellist, Mr. Michael Thöne, from FIFO and GSI, Germany.

Mr. Michael Thöne focused his intervention on present and upcoming challenges for state aid control. One of them was of course the economic and financial crisis: will subsidies be easily reduced once the crisis will be over? Second, globalisation intensifies competition between countries, especially for foreign investment. It could make the problem of subsidy races more acute, it could also in some cases result in a protectionist backlash, possibly inducing a growing use of subsidies.

The third and newest challenge was climate change and sustainable development. Mr. Thöne gave the examples of fossil fuels and biofuel subsidies. He raised the question of the compatibility between competition policy and sustainable development: while competition policy is traditionally focused on final goods and services, this focus might be questioned in the light of growing environmental concerns. For instance, how will the expenses for adaptation to climate change be dealt with? Do State aids have a role to play in this respect?

Mr. Thöne then discussed the question of subsidy control. At the national level, subsidy control mainly consists in assessing whether the purported justification for an aid measure is convincing, whether the subsidy addresses a true market failure and whether it is the best instrument to correct such market failure. Mr. Thöne regretted that the independence and resources of the bodies responsible for subsidy control were often rather limited for political reasons. Given this, he called for the development of in-depth and transparent evaluation of every subsidy measure. Such evaluations would be necessary to implement efficient state aid control systems. Mr. Thöne gave the examples of the EU and the WTO. He praised the EU system but pointed out the flaws of WTO rules. According to him, WTO subsidy rules were not effective because they were not deterrent enough.

The Chairman thanked Mr. Thöne and the other panellists for their thoughtful comments. He also thanked the country representatives for their very interesting written contributions. Then, the Chairman opened the general discussion by setting out its four main topics:

1. The current situation of state aids and subsidies, and their control;
2. Their possible adverse impact;
3. Their possible justifications and limits; and
4. The steps that could be taken to improve the assessment and the control of state aids and subsidies.

1. The current situation of state aids and subsidies, and their control

In relation to the first theme, the Chairman noted large disparities across countries as regards state aid control rules and that in some countries, such as Mongolia, there was no state aid control. The Chairman then asked the representative from Mongolia to explain Mongolian policy regarding state aids.

The representative from Mongolia explained that state aids and subsidies had been used as an instrument to pursue social and economic goals. In 2008 and 2009 they had been directed to agricultural, construction and educational sectors, as well as to petroleum production. Most of the subsidies were granted to help small and medium sized enterprises to overcome the financial crisis. The Mongolian representative also noted that the law prohibiting unfair competition contained a provision allowing for the control of subsidies restricting competition. However, the Mongolian Competition Authority has not yet dealt with any case involving state aids and subsidies. As regards petroleum price increases, the Competition Authority supported the government's decision to grant customs tax reduction for petroleum import because Rosneft, a Russian company, was a monopoly supplier of petroleum in Mongolia, and had steadily increased its prices.

The Chairman then noted that in Pakistan, the government grants state aids and subsidies on a case-by-case basis. He therefore asked the Pakistani Representative to set out the broad principles underlying the government's decisions.

The representative from Pakistan explained that the main reason why the Pakistani government granted state aids was to keep failing State-owned enterprises (SOEs) afloat. Very often, SOEs are also large employers. For instance, Pakistan International Airlines is the largest recipient of state aids, mainly because of its inefficiency (the employee-to-aircraft ratio is 418 to 1 compared to a worldwide average of 130 to 1). At first, the Pakistani government granted state aids to offset low levels of private investment. Afterwards, it kept cooperating with private firms. The Pakistani representative concluded his intervention by stressing that the Competition Commission had an important advisory role with regards to state aid measures, in particular by issuing policy notes that were taken into account by the government.

The Chairman then turned to the representative from the US Federal Trade Commission. He invited him to present the principles underlying the interventions of the FTC before courts. The US representative reminded that the better the FTC's empirical work, the greater its influence in judicial proceedings. FTC work relies on a combination of three elements. First, the FTC conducts frequent workshops on specific markets, especially new or evolving markets that could be the subject of future litigation. The FTC has been particularly concerned with the various distortions that have been affecting the development of the Internet as an alternative to traditional business distribution. Second, the FTC tries to gather empirical evidence in order to be able to provide courts with reliable accounts of the likely or actual economic effects

of the measures at stake. Third, the FTC attempts to promote internal cooperation, in particular between economics researchers, legal services, the Office of policy planning and the Bureau of competition.

The Chairman then turned to the second subtopic of the first theme of the roundtable. It focused on supranational state aid control. He asked the representative from WAEMU, Mr. Amadou Dieng, to take the floor again to explain in greater detail the intervention of the Commission in the SOCOCIM case.

Mr. Dieng explained that supranational principles were essential to foster regional integration, especially in developing countries. In most cases, firms complain before supranational authorities because of the absence of satisfactory solution at the national level. This explains why national governments were quite reluctant to conform to the Commission's rulings. The WAEMU representative then came back to the SOCOCIM case. The Commission eventually convinced the Senegalese authorities that the aid that had been granted to the Ciments du Sahel was likely to jeopardize the activities of SOCOCIM, an important firm with a market share of at least 60% and employing more than 700 persons. Furthermore, the Commission also confirmed that *ex post* assessment of state aid measures was an essential part of an efficient state aid control system. Indeed, in the case at hand, the Commission has been able to convince the Senegalese government that: (i) the Ciments du Sahel had taken advantage of the imperfect implementation of the aid scheme; and (ii) the aid had not benefited the economy as much as they had planned.

The Chairman then noted that the European Union had been fostering procedural simplification by implementing in 2008 a Simplified Procedure and a Best Practices Code. He asked the European Union representative to give a short overview of these measures. In particular, he asked him to look back at what had been achieved and to point out the eventual unexpected adverse effects of these procedural reforms.

The European Union representative highlighted that the European Commission tries to limit the review of state aid measures to cases that pose a threat to competition and trade between Member States. The procedural simplification that has taken place in the last two years aimed at limiting the administrative burden as much as possible for cases which were unlikely to constitute a big threat to competition and trade. He then described European state aid rules. He insisted on the fact that many state aid measures do not have to be notified to the Commission. Indeed, in 2006, the so-called *de minimis* threshold was raised. Under 200 000 € per company and per period of three years, state aid measures do not have to be notified at all. Second, the General Block Exemption Regulation was enlarged. The Block Exemption lists measures that do not have to be notified to the Commission *ex ante*. The vast majority of aid measures, such as aid to small and medium enterprises, or aid for training, employment, innovation, as well as environmental aid and regional aid, fall under the Block Exemption.

Furthermore, a simplification package has been implemented for the measures that still need to be notified. It consists in two blocks. The first block is the Simplification Procedure. It tackles straightforward cases and cases for which the Commission has much case experience. The idea is to have an accelerated time frame for these measures. The second block is the Best Practice Code. It concerns the cases that are too complex to be tackled under the Simplified Procedure. The objective is to rely on the partnership between the Commission and the Member State by developing pre-notification meetings. Since the simplification package only came into force on September 1, 2009, the European representative acknowledged that it was impossible yet to assess its efficiency. However, there were a growing number of cases notified under the Simplified Procedure and the Best Practice Code. This seems to have significantly reduced the duration of investigation for complex state aid cases. Another success worth mentioning was that the percentage of aid measures covered by the general Block Exemption had increased from 34% to 66% within the last 2 years.

2. The possible adverse impact of state aids and subsidies

The Chairman then introduced the second theme of this roundtable, i.e. the possible adverse impact of state aids and subsidies. He emphasised the quality of the Egyptian contribution, which pointed out the adverse impact on competition of high levels of under regulated state aids and subsidies. The Chairman called for comments from Egypt on the nature and magnitude of the anti-competitive effects resulting from government subsidies in Egypt.

The representative from Egypt first stated that Egypt, like many countries, did not have any specific regulation regarding state aids and subsidies. Furthermore, the Egyptian Competition Law does not prohibit state aids distorting competition. This explained why the Egyptian Competition Authority had not been involved in any state aid case yet. However, the Egyptian representative explained that the Competition Authority was aware of the importance of controlling state aids, all the more so that Egypt is supposed to put a state aid control system into force in order to comply with a trade agreement with the European Union. In addition to the usual instruments (direct financial transfers, tax breaks, granting government-owned inputs at a below-market rate...), state aids may also take the form of preferential regulations. The representative gave the example of the Egyptian Civil Aviation Law, which specifically mandates that “no airline can be licensed to operate on internal routes that compete with itineraries of currently operating Egyptian companies” although there is only one company operating in Egypt. He concluded by stressing that the Egyptian Competition Authority was considering the inclusion of provisions regarding state aids and subsidies in competition law.

The Chairman then asked the Polish representative to comment on the commitments that ailing firms seeking aid have had to make in order to limit the adverse impact of aids on competition. The representative from Poland explained that, when assessing the efficiency of compensatory measures, one must take into account the effects of these measures both on the benefiting company and on competition in the affected market. Compensatory measures tend to reduce the beneficiary’s total production capacities. This in turns benefits its competitors. The European Commission further requires the beneficiary to provide periodic reports (every six months) so as to check that the compensatory measure has been effectively implemented. Most companies agree to implement compensatory measures for fear of a Commission decision obligating them to give back the aid. This is a good example of the efficiency of *ex post* control over state aids.

The Chairman then noted that the contribution from Chinese Taipei described an interesting state aid case under the form of subsidies granted to farmers for pesticide purchase. They had been subject to specific regulation because they were likely to impede competition. The representative from Chinese Taipei was invited to elaborate on this case. The representative explained that in Chinese Taipei, most state aids were directed to the promotion of R&D in specific sectors, such as high-technology industries as well as to the agricultural sector and to small and medium sized enterprises. He then commented on the case mentioned by the Chairman. In the late 1990s, the Council of Agriculture authorised the Farmers Association to select its pesticide suppliers by means of a public procurement and then to resell the pesticides to farmers at a lower price. In 1998, private retailers selling pesticide complained to the Fair Trade Commission, arguing that this scheme was making competition unfair. The Fair Trade Commission decided to prohibit the Farmers Associations from selling pesticides to its members at a price below the purchase price. Furthermore, it also prohibited any subsidies directed to farmers that were not justified by emergency needs.

The Chairman noted that adverse effects may also derive from the large costs that high levels of state aids and subsidies may represent for governments. He then gave the floor to the Indian representative whose contribution specifically dealt with the impact of high amounts of aids on the government budget.

The representative from India noted that in his country, the Competition Commission had only come into existence 11 months ago and that state aids and subsidies did not fall under its jurisdiction. He also explained that in India, subsidies are granted by state governments as well as by the central government. As regards measures undertaken by the central government, in 2002-2004, subsidies represented around 4% of GDP and accounted for approximately 80% of the fiscal deficit. This had been the subject of intense public debates. Many studies and committees stressed the urgency to reform the control over state aids and subsidies. According to the Indian representative, the central government seemed to agree on the need for a subsidy reform.

The Chairman asked India what share of the fiscal deficit was respectively due to aids directed to producers and to aids directed to customers. The Indian representative replied that the largest share of subsidies went to supporting food prices. There is, for instance, a minimum support price for rice and wheat. The scheme was designed in order to serve as a buffer when there is a shortage of grains. Similarly, there is a minimum price for fertilizers.

The Chairman then turned to Russia. He noted the amendments made in 2009 to the state aid provisions of the 2006 Russian Federal Law on Competition. He asked the representative from the Russian Federation to explain the rationale for such amendments.

The Russian representative explained that the 1991 competition legislation prohibited the provision of competitive advantages to specific economic entities. In order to ensure the existence of a pro-competitive and transparent state aid system, a provision relative to the granting of state or municipal aid has been added to the competition law in 2006. This law defines a number of policy objectives for which state aids are authorised, such as social or cultural goals. In October 2009, the terms “state and municipal aids” were replaced by the terms “state or municipal preferences”. State or municipal preferences are defined as the provision of advantages to specific economic entities, including by non-monetary means. This definition is broader and it better complies with the standards of the European competition law. From a procedural viewpoint, the provision of preferences requires the prior consent of the Federal Antimonopoly Service (“FAS”) of Russia. Moreover, the FAS has the power to bring a case to Court in order to obtain the recovery of illegal state aids.

3. The possible justifications and limits of state aids and subsidies

The Chairman then introduced the third part of the roundtable, dealing with the reasons justifying state aids in some circumstances. He noted that in his speech, EU Commissioner Almunia had pointed out various cases where state aids and subsidies could be justified. Mr. Frédéric Jenny then asked Romania to describe a specific state aid scheme, directed to small and medium sized enterprises in the context of the financial crisis.

The representative from Romania first stated that EU regulation was directly applicable to Romania. He insisted on the fact that no Romanian bank has encountered any financial difficulties in the context of the financial crisis. Thus, they did not need any specific state aid measure. In the real economy, several state aid schemes had been approved by the European Commission under the EC Temporary Framework. Among them, two state aid schemes had been designed to help companies weather the crisis. The first one consisted in state guarantees granted to SMEs and large companies in order to facilitate their access to credit. The second one was directed specifically to SMEs and took the form of subsidised loans and of loan guarantees at a reduced premium. Both schemes are allowed until the end of 2010. Only firms that had financial difficulties at the moment of the guarantee request can benefit from the schemes.

The Chairman turned to Argentina, noting that, according to the Argentinean contribution, the main justification for state aids and subsidies was the protection of employment. In particular, the contribution

discussed a case where General Motors was granted subsidies for developing a car in which a large share of all components had to be domestically produced. He wondered whether the aid was effective in promoting employment and whether it created competition problems

The Chairman then referred to the contribution from Morocco. It described the main policy trade-offs and argued that some state aids may be justified despite their anticompetitive effects. For instance, agricultural subsidies did not seem to be economically justified, but they have an important social dimension. The Chairman then asked the representative from Morocco to probe into this trade-off and to assess the sustainability of this policy on the long run.

Morocco first stated that the largest sectors in the Moroccan economy are the agricultural sector and the small and medium sized enterprises. Both sectors needed state intervention because of the intensity of international competition. State aids were thus an instrument to ensure social cohesion and maintain employment. State aids took various forms, and it was worth mentioning that direct subsidies had been forbidden in Morocco since 2000. The Moroccan government had taken several crisis-related measures, especially directed to exporting firms. However, the Moroccan representative stressed that these measures were non-discriminatory since every firm meeting predetermined objective criteria might benefit from the scheme. He underlined the important advisory role played by the Competition Authority as regards state aids measures. Moreover, he noted that Morocco had an obligation to prohibit subsidies distorting trade with the European Union in order to comply with several trade agreements.

4. The steps that could be taken to improve the assessment and the control of state aids and subsidies.

The Chairman presented the fourth discussion theme of the roundtable. As was shown when discussing the first topic, there was a lot of cross-country heterogeneity regarding the control over state aid, or lack thereof. This raised the question of how state aids and subsidies should be controlled. In this respect, some contributions provided interesting elements, regarding the *ex ante* or *ex post* treatment of state aids and subsidies. Ukraine, for instance, was currently constructing a state aid monitoring system complying with the Free Trade Area Agreement concluded with the European Union. With EU technical support, a workgroup had been developing a draft concept of the state aid system that should serve as a basis for the future legislation on state aids.

The Chairman asked the Ukrainian representative to review the achievements of this workgroup and to explain what is still necessary to implement an efficient state aid monitoring system. The representative first stressed the existing consensus in Ukraine on the necessity to implement a transparent state aid control system. On 13th January 2010, a draft has been adopted by the Parliament. It had been elaborated by the Antimonopoly Committee and supported by the government. It pursues five main goals: (i) the establishment of a state aid monitoring system; (ii) the inventory of every state aid measure that is granted in Ukraine; (iii) the drafting of general advice to help public authorities balance the positive and negative effects of a state aid measure; (iv) the submission of annual reports on volumes and forms of state aids and subsidies granted in Ukraine; and (v) the establishment of a control mechanism over state aids. This aims at minimising the negative impact of state aids and subsidies on competition. The Ministry of Finance will be responsible for the implementation of the first four goals while the Antimonopoly Committee will have to assess the impact of state aid measures on competition. The Ukrainian representative concluded his intervention by underlying that the adoption of this draft contributes to the fulfilment of Ukraine's international commitments.

The Chairman then turned to the Former Yugoslav Republic of Macedonia (FYROM). He noted that FYROM contribution emphasised the strict conditions attached to the granting of aid to ailing firms. These conditions regard for instance the repayment of special loans, and the contribution of the beneficiary to the

improvement of market conditions. He asked the FYROM representative to describe in greater detail how *ex post* control is implemented. In particular, what sanctions can be taken against the firms that do not abide by these conditions? Are there some recent cases worth mentioning?

The FYROM representative explained that the Commission for the Protection of Competition was the institution responsible for state aid control and that the state aid rules in force since 2004 perfectly comply with EU legislation. State aid measures must be notified to, and authorised by the Commission for the Protection of Competition before being implemented. The Commission can also impose the recovery of unlawful aid. So far the Commission has opened three formal investigation procedures upon doubts about the compatibility of state aids. In two of these cases, the aid provided was considered unlawful and had consequently been recovered. Both cases implied the selling of land owned by state enterprises at a below-market price. The recovery decision meant that in both cases, the beneficiary of the aid had to pay the full market price of the land. Both decisions of the Commission had been appealed in the administrative court and were now pending.

The Chairman turned to Spain, noting that Spanish aids must indeed comply with EU rules. However, *de minimis* state aids do not fall under the jurisdiction of the European Commission. For this kind of aids, the Spanish Competition Act provides the Competition Authority with an instrument for *ex post* control. The Chairman requested the Spanish representative to comment on the relevant provisions. In particular what loophole in EU state aid control did this act provide an answer to?

The Spanish representative explained that the 2007 Spanish Competition Act allows the National Competition Authority to analyse state aid schemes under its own initiative or at the request of public administrations. The goal was to evaluate the potential effects on competition of such schemes. If state measures that may constitute aid fall under the EU jurisdiction, the Competition Authority then recommends notifying the Commission. Two important and recent cases (concerning a proposal to support the coal mining sector and a law regarding the financing of a public broadcasting system) were thus notified. In cases falling below the *de minimis* threshold, the Competition Authority issues reports assessing the pros and cons of the measure at hand. Indeed, these reports warn public authorities on the adverse effects of their intended measures and try to identify less distortive alternatives. In addition, the Competition Authority has published its first annual report in 2009. This report was mainly methodological and intended to set up the economic criteria used for the assessment of state aid measures. Eventually, the Spanish representative explained that the Competition Authority has an instrument for *ex post* control. It has the power to bring actions before Courts against administrative initiatives hindering the maintenance of effective competition on the markets. So far this instrument has not been used but it has proved to be a powerful deterrence tool in the Competition Authority's interaction with public administrations.

The Chairman turned to Croatia. He noted that according to the Croatian contribution, several investigations had been opened following complaints about discriminatory treatment compared to competitors benefiting from state aids, in particular in the textile industry. The Chairman invited Croatia to briefly present one or two of such cases.

The representative from Croatia stated that the Croatian Competition Authority was responsible for the implementation of the state aid regulation. It had already opened several investigations which were all pending. In Croatia, the State Aid Act sets out general conditions and rules for authorisation, monitoring and recovery of state aids. State aids are defined as any actual or potential expenditure or decreased revenue of the State, granted in whatever form distorting or threatening to distort competition by favouring certain beneficiaries. Defined as such, state aid measures are forbidden by law. However, state aids can serve to compensate damage caused by exceptional natural disasters. In such case, they may be declared compatible with the law but they are subject to the prior authorisation of the competition agency. The Competition Authority monitors the implementation of state aids authorised at its own initiative or upon request of any entity having a legal interest. In cases where the Authority establishes that there have been

irregularities in monitoring the implementation of state aids, it can adopt a decision ordering the aid provider or the aid beneficiary to remedy the irregularities in question within three months.

The Chairman then invited the Business and Industry Advisory Committee (BIAC) to explain its views on the best way to conduct the efficient *ex ante* and *ex post* economic assessment of a state aid measure. The representative from BIAC stressed that the business community calls for the assessment, on a case-by-case basis, of the effects of subsidies on competition. He explained that national authorities alone cannot control state aids and subsidies because many of them involve international issues. However, as far as possible, they should promote the transparency of state aid. He also pointed out that the financial crisis had shed new light on the effect of subsidies. It shown that they can also have positive effects, since they can help correct market failures. According to BIAC, state aids allowed to save many efficient producers who may have otherwise faced bankruptcy when the flow of credit dried up.

As regards the *ex ante* assessment of state aid measures, BIAC welcomed the introduction of the Simplified Procedure by the European Commission because it accelerates the treatment of many cases. According to the BIAC representative, the difference between the EU and the WTO is that the EU's main objective was the common economic interest of the European community. On the contrary, the WTO did not look at the common good but was rather interested in whether there is an undue benefit to a specific competitor. Moreover, WTO rules only allowed for *ex post* control, which is efficient only if countervailing measures are applied in the market in which the harm has occurred. Nevertheless, as BIAC mentioned, countervailing measures often harm consumers by raising prices.

The Chairman turned to Peru. The representative from Peru indicated that Peru has not developed a full framework to analyse state aids yet. As regards government interventions through SOEs, there exists *ex ante* and *ex post* control. *Ex post*, companies can file complaints to the Competition Authority if they believe that an SOE's behaviour is unduly affecting them. *Ex ante*, the government is subject to a three-stage test when creating new SOEs: (i) State participation in the business activity should be authorised by a special law and must thus be approved by the Congress; (ii) State intervention should not foreclose the entry of new competitors in the market nor exclude incumbent competitors; and (iii) State participation in business activities is allowed only were it fosters public interest.

Finally, the Chairman asked the three experts panellists to present their concluding remarks.

Mr. Amadou Dieng first insisted on the difference between individual aids and general schemes. According to him, general schemes are economically justified most of the time. The important issue was the monitoring of the implementation of the aid. This monitoring must take place on a case-by-case basis. Indeed, most distortions do not come from the aid measure itself but derive from the way it is implemented. It is thus crucial to give to the Competition Authorities the control over the implementation of the aid. *Ex post* control is thus as necessary as *ex ante* control.

Mr. David Spector probed into the question of the standard of proof in state aid cases. He drew a comparison between merger and state aid cases. In both cases, competition authorities weigh the *pros* and the *cons*; the possible efficiencies on the one hand and the possible anticompetitive effects on the other. In doing so, they should, according to Mr. Spector, have a slightly negative *a priori* assumption: in principle, aids are prohibited unless some conditions are fulfilled. The reason is that some harmful effects of aids are very indirect and do not lend themselves easily to measurement. Rent-seeking and the harmful incentives resulting from the soft budget constraint are two examples of negative indirect effects of state aids that are not limited to the sector where the aid is granted. Similarly the harm resulting from the high opportunity cost of public funds is also an indirect effect of state aids and it is usually not accounted for when weighing the *pro* and *cons* of an aid measure. According to Mr. Spector, all these reasons pointed towards a negative presumption and called for a relatively high standard of proof before considering that a given aid measure was justified.

Mr. Michael Thöne made three comments about the discussions. First, he agreed that subsidy control was to be exerted on a case-by-case basis. However, he regretted that competition authorities focus too much on specific cases, and do not provide general assessments of the state aid policy pursued by governments. This could be very useful to improve transparency and deterrence. Second, Mr. Thöne encouraged competition authorities to adopt a broader view on state aid measures. They should not only balance the positive and negative effects of a given measure, but also determine whether the policy decision was justified or not in the first place. Finally, he commented on the Polish representative's intervention, saying that he found it very interesting to obligate the firms benefiting from a state aid measure to assess the negative impact that this measure could have on competitors.

The Chairman then asked BIAC to comment on cases of aids granted to SOEs. The BIAC representative expressed his concern about SOEs, and in particular, about their ability to predate as well as to discriminate upstream and downstream. However, he acknowledged that SOEs are not harmful in themselves and reaffirmed that it is harm to competition rather than harm to competitors that must be taken into account when assessing the effect of an aid measure.

The Chairman of the session, Mr. Mestassi, asked Mr. Frédéric Jenny to make some concluding remarks. Mr. Jenny outlined a few points that emerged from the discussion. First, he noted that on the issue of state aids, there was no divide between OECD members and non-members, developing and developed countries. As shown by Mr. Spector, this issue was important in all countries. Second, Mr. Jenny noted that there is no automatic prejudice against state aids. As explained by Commissioner. Almunia, there are good reasons to justify state aids in some circumstances, such as the need to correct market failures, or the promotion of investment generating positive externalities. Economists are quite familiar with these goals. Others are more political: they concern the promotion of social goals, which may be justified even if they are not entirely consistent with standard economic analysis, which tends to promote the use of direct, non-distortive transfers. Morocco, for example, explained very clearly that some social goals had to be weighed against efficiency considerations: the government at large is not only concerned with competition but also with broader issues. Third, Mr. Frédéric Jenny noted that the interventions and country contributions showed that almost all sectors of the economy benefit from state aids. However, a consensus emerged on the view that state aids tend to make the playing field uneven. This does not only concern competition between firms but also competition between nations. A large share of state aids may have an impact on international trade.

According to Mr. Jenny, this highlights the need for an efficient system of control of state aid. State aid control takes place at the national, regional and multilateral levels. The main features of state aid control should be the following: transparency, non-discrimination, and making sure that aid does not distort competition. This requires an assessment of the effects of the aids on a case-by-case basis. In each case, whether the aid measure at stake is the best way to achieve its purported goal should be examined in detail. The roundtable also made it clear that there was a plurality of ways in which competition authorities can intervene. For competition authorities that do not have a strict mandate to control state aids, policy notes, various types of advocacy, and interventions before Courts, can be ways to influence governments' decisions.

COMPTE RENDU DE LA DISCUSSION

Par le Secrétariat

M. Frédéric Jenny, en qualité de Président du Forum mondial sur la concurrence, remercie le Commissaire européen chargé de la concurrence, M. Joaquim Almunia, pour l'intérêt de son discours sur la politique de la Commission européenne en matière d'aides publiques. M. Jenny présente ensuite le Président de la première session sur la Politique de la concurrence, les aides publiques et les subventions : M. Monkid Mestassi, Secrétaire Général du ministère de l'Économie et des Affaires générales du Maroc.

M. Mestassi présente les trois experts qui participent à cette session : M. David Spector, Professeur associé à l'École d'économie de Paris (fondateur de MAPP, un cabinet de conseil spécialisé dans l'économie de la concurrence); M. Amadou Dieng, Directeur de la concurrence au sein de la Commission de l'Union économique et monétaire ouest-africaine (UEMOA) ; et M. Michael Thöne, de l'Institut FIFO, qui participe à la *Global Studies Initiative* en Allemagne.

M. David Spector débute son intervention en soulignant l'importance de la question des aides publiques et des subventions. Les aides publiques représentent encore une large proportion des fonds publics, mais hors de l'Union européenne, elles ne sont soumises qu'à un contrôle très sommaire. M. Spector décrit la grande variété d'instruments et de bénéficiaires de ces aides, ainsi que la diversité des règles de contrôle existant à l'échelle nationale.

Il observe que le Commissaire Almunia a déjà amplement traité des arguments économiques pouvant justifier les aides publiques. M. Spector axe donc sa présentation sur les divers effets dommageables que peuvent avoir ces aides. Il explique, dans un premier temps, que pour évaluer l'efficacité d'une aide, il convient de tenir compte du coût de la levée des fonds publics et du coût d'opportunité des aides publiques. Le coût d'opportunité semble devoir être élevé dans les pays en développement, où le rendement des utilisations alternatives des deniers publics (santé ou éducation, par exemple) est supérieur à celui observé dans les pays développés.

Les aides publiques peuvent aussi produire des effets dommageables directs. Premièrement, c'est le cas des courses aux subventions qui découlent d'un manque de coordination entre les gouvernements. Deuxièmement, les aides peuvent faire obstacle aux signaux émis par le marché, créant ainsi des distorsions, ainsi que des inefficiences dans la production et dans l'allocation des ressources. Les subventions versées dans les secteurs de l'énergie et de l'eau illustrent ce phénomène. Troisièmement, lorsqu'elles ont pour seul objectif de maintenir à flot des entreprises en difficulté, les subventions entraînent généralement une mauvaise allocation du capital et de la main-d'œuvre. Enfin, les aides publiques jouent sur les incitations auxquelles sont exposées les entreprises en raison d'un phénomène de « faible contrainte budgétaire » : les entreprises qui s'attendent à être renflouées en cas de difficultés ou à ce que leurs rivaux moins chanceux le soient en cas de perte de compétitivité sont moins incitées à innover, réduire les coûts ou accroître la qualité et la diversité de leur offre.

M. Spector s'associe au Commissaire Almunia qui a salué l'évolution de la Commission européenne vers une approche plus économique des aides publiques. M. Spector présente les grands principes de cette approche. Il y a lieu tout d'abord de cerner la défaillance réelle du marché à l'origine de chaque aide

publique, de déterminer si une aide publique convient pour y remédier, et si cette aide est bien le mécanisme de correction qui crée le moins de distorsions.

M. Spector conclut en formulant plusieurs recommandations sur le rôle futur des autorités de la concurrence. Outre le traitement des affaires de comportement anticoncurrentiel de la part des organismes publics, les autorités de la concurrence doivent jouer un rôle actif de conseil et de sensibilisation. Elles doivent faire la lumière sur le montant des subventions non justifiées et sur l'identité des bénéficiaires. Le surcroît de transparence qui en découlera permettra de diminuer considérablement la fréquence des aides publiques et des subventions et de mieux les cibler.

Le Président donne ensuite la parole au deuxième expert, M. Amadou Dieng, de l'UEMOA.

M. Amadou Dieng explique tout d'abord que l'exercice d'un contrôle efficient sur les aides publiques et les subventions a constitué un outil décisif de consolidation du marché commun de L'Union économique et monétaire ouest-africaine (l'UEMOA qui compte 8 pays d'Afrique de l'Ouest). L'épargne publique étant insuffisante, ces pays ont terriblement besoin de l'investissement étranger et ont donc intérêt à accorder des aides qui souvent faussent la concurrence entre les États membres.

Puis, M. Dieng commente une affaire importante qui met en lumière les difficultés rencontrées par la Commission de l'UEMOA pour faire respecter les règles applicables aux aides publiques. Cette affaire d'aide illicite a été la première dont s'est saisie la Commission. Elle mettait en présence deux producteurs de ciment, la SOCO CIM et les Ciments du Sahel. La SOCO CIM était implantée au Sénégal depuis 30 ans, mais le gouvernement sénégalais considérait que l'approvisionnement en ciment demeurait insuffisant. Il a donc accordé des exonérations d'impôt aux Ciments du Sahel, qui ont ainsi acquis un avantage concurrentiel certain par rapport à la SOCO CIM.

La Commission a interdit ce dispositif en raison de la distorsion de concurrence en résultant. M. Dieng souligne que cette décision a représenté une belle réussite pour la Commission. Il aurait souhaité, toutefois, que la Commission soit en mesure d'imposer le recouvrement des aides allouées.

Le Président donne ensuite la parole au troisième expert, M. Michael Thöne, de l'Institut FIFO et de GSI, en Allemagne.

M. Michael Thöne cible son intervention essentiellement sur les enjeux présents et à venir dans le domaine du contrôle des aides publiques. L'un d'eux est à l'évidence la crise économique et financière : pourra-t-on facilement diminuer les subventions une fois la crise passée ? Le second enjeu est celui de la mondialisation, qui avive la concurrence entre les pays, notamment en matière d'investissement étranger. On pourrait assister à une exacerbation du problème des courses aux subventions et, dans certains cas, à des réactions protectionnistes, voire à une intensification du recours aux subventions.

Le troisième enjeu, et le plus récent, correspond au changement climatique et au développement durable. M. Thöne cite les exemples des subventions aux combustibles fossiles et aux biocarburants. Il soulève la question de la compatibilité entre la politique de la concurrence et le développement durable : si la première est traditionnellement centrée sur les biens et services finaux, cette orientation pourrait être remise en question à la lumière des préoccupations environnementales croissantes. On peut se demander, par exemple, comment prendre en charge les dépenses occasionnées par l'adaptation au changement climatique ? Les aides publiques ont-elles un rôle à jouer à cet effet ?

M. Thöne examine ensuite la question du contrôle des subventions. À l'échelle nationale, le contrôle des subventions consiste pour l'essentiel à déterminer si l'argument censé justifier une aide est convaincant, si la subvention répond à une véritable défaillance du marché et si c'est l'instrument le plus indiqué pour y remédier. M. Thöne regrette que l'indépendance et les ressources des organes responsables

du contrôle des subventions soient fréquemment plutôt limitées pour des raisons politiques. Il en appelle donc à une évaluation en profondeur et transparente de chaque subvention. Ces évaluations seraient nécessaires à la mise en place de systèmes efficaces de contrôle des aides publiques. M. Thöne cite les exemples de l'UE et de l'OMC. Il souligne les mérites du système de l'UE, mais relève les carences des règles de l'OMC. Selon lui, les règles de l'OMC applicables aux subventions ont manqué d'efficacité car elles n'étaient pas assez dissuasives.

Le Président remercie M. Thöne, ainsi que les autres experts pour leurs commentaires pertinents. Il remercie également les représentants des pays pour leurs très intéressantes contributions écrites. Puis il ouvre le débat général en présentant ses quatre thèmes principaux :

1. la situation actuelle et le contrôle des aides publiques et des subventions ;
2. leurs éventuelles répercussions négatives;
3. leurs justifications et leurs limites éventuelles ;
4. les mesures pouvant être appliquées pour améliorer l'évaluation et le contrôle des aides publiques et des subventions.

1. La situation actuelle et le contrôle des aides publiques et des subventions

En liaison avec le premier thème, le Président relève de fortes disparités entre les pays au regard des règles de contrôle des aides publiques, et il observe que certains, comme la Mongolie, n'exercent aucun contrôle en la matière. Il invite ensuite la représentante de ce pays à exposer la politique d'aides publiques qui y est menée.

La représentante de la Mongolie explique que les aides publiques et les subventions ont été utilisées pour poursuivre des objectifs sociaux et économiques. En 2008 et 2009, elles ont été affectées aux secteurs de l'agriculture, de la construction et de l'éducation, ainsi que de la production de pétrole. La majorité ont été accordées afin d'aider des PME à surmonter la crise financière. La représentante de la Mongolie fait également observer qu'une disposition de la loi interdisant la concurrence déloyale prévoit l'exercice d'un contrôle sur les subventions qui ont pour effet de restreindre la concurrence. Cela étant, l'Autorité mongole de la concurrence n'a traité à ce jour aucune affaire impliquant des aides publiques ou des subventions. En ce qui concerne les hausses du prix du pétrole, l'Autorité de la concurrence a soutenu la décision du gouvernement d'alléger les droits de douane sur les importations de pétrole, puisque la société russe Rosneft détenait le monopole de l'approvisionnement de la Mongolie en pétrole et qu'elle n'avait cessé de relever ses prix.

Le Président constate alors qu'au Pakistan le gouvernement octroie les aides publiques et subventions au cas par cas. Il demande donc au représentant de ce pays de présenter les grands principes qui président aux décisions du gouvernement.

Le représentant du Pakistan explique que le gouvernement a essentiellement accordé des aides publiques pour maintenir à flots les entreprises publiques en difficulté. Ces entreprises sont aussi bien souvent d'importants employeurs. Ainsi, Pakistan International Airlines est le premier bénéficiaire des aides publiques, en raison principalement de son inefficience (le ratio salarié-avion est de 418 pour 1, contre 130 pour 1 en moyenne à l'échelle mondiale). Le gouvernement pakistanais a octroyé des aides publiques tout d'abord pour compenser la faiblesse de l'investissement privé. Puis il a continué de coopérer avec des entreprises privées. Le représentant du Pakistan conclut son intervention en insistant sur l'importance du rôle consultatif joué par la Commission de la concurrence au regard des aides publiques, en particulier à travers la publication de notes d'orientation dont le gouvernement tient compte.

Le Président s'adresse ensuite au représentant de la Commission fédérale du commerce des États-Unis. Il l'invite à présenter les principes sur lesquels sont fondées les interventions de la Commission devant les tribunaux. Le représentant des États-Unis rappelle que plus les travaux empiriques de la Commission sont aboutis, plus elle est en mesure d'influer sur les procédures judiciaires. Les travaux de la Commission reposent sur trois éléments à la fois. Premièrement, la Commission organise fréquemment des ateliers sur des marchés précis, en particulier les marchés nouveaux ou en mutation qui sont susceptibles de faire l'objet de litiges ultérieurement. Elle s'est notamment inquiétée des différentes distorsions qui ont pesé sur le développement d'Internet en tant que canal de substitution à la distribution commerciale traditionnelle. Deuxièmement, elle s'efforce de recueillir des données d'observation pour pouvoir présenter aux tribunaux un exposé fiable des effets économiques probables ou réels des mesures en jeu. Troisièmement, la Commission s'emploie à promouvoir la coopération interne, notamment entre les chercheurs en économie, les services juridiques, le Bureau de planification des politiques et le Bureau de la concurrence.

Le Président passe ensuite au deuxième sous-thème du premier thème de la table ronde, consacré au contrôle supranational des aides publiques. Il demande alors au représentant de l'UEMOA, M. Amadou Dieng, de prendre de nouveau la parole afin d'expliquer plus en détail l'intervention de la Commission dans l'affaire de la SOCOCIM.

M. Dieng explique que l'élaboration de principes supranationaux est un aspect fondamental de la promotion de l'intégration régionale, en particulier dans les pays en développement. Dans la plupart des cas, les entreprises déposent plainte auprès des autorités supranationales du fait de l'absence de solution satisfaisante à l'échelle nationale, ce qui explique pourquoi les autorités nationales montrent fort peu d'empressement à se conformer aux décisions de la Commission. Le représentant de l'UEMOA revient ensuite sur l'affaire de la SOCOCIM. La Commission a fini par convaincre les autorités sénégalaises que l'aide accordée aux Ciments du Sahel risquait de mettre en péril les activités de la SOCOCIM, société importante détenant au moins 60 % du marché et employant plus de 700 personnes. De plus, la Commission a aussi confirmé que l'évaluation *ex post* des aides publiques concourait de façon déterminante à l'efficacité du système de contrôle des aides publiques. Dans l'affaire en question, en effet, la Commission a pu convaincre le gouvernement sénégalais que : (i) les Ciments du Sahel avaient tiré profit de la mise en œuvre imparfaite du régime d'aide ; et (ii) l'aide n'avait pas bénéficié à l'économie autant qu'on le prévoyait.

Ensuite, le Président fait remarquer que l'Union européenne a favorisé une simplification des procédures en mettant en place en 2008 une Procédure simplifiée et un Code de bonnes pratiques. Il demande au représentant de l'Union européenne de présenter ces mesures dans leurs grandes lignes, et en particulier de revenir sur les réalisations accomplies et de mettre en exergue les effets dommageables inattendus et éventuellement produits par ces réformes procédurales.

Le représentant de l'Union européenne souligne que la Commission européenne s'efforce de limiter l'examen des aides publiques aux affaires qui risquent de compromettre la concurrence et les échanges entre les États membres. La simplification des procédures réalisée ces deux dernières années devrait permettre de limiter autant que possible la charge administrative pour les affaires qui selon toute probabilité ne présentent aucun danger pour la concurrence et les échanges. Il décrit ensuite les règles européennes qui encadrent les aides publiques. Il insiste sur le fait que, pour beaucoup, ces aides n'ont pas à être portées à la connaissance de la Commission. En 2006, en effet, le seuil dit *de minimis* a été relevé. En deçà de 200 000 EUR par entreprise et par période de trois ans, les aides publiques n'ont pas à être déclarées. Deuxièmement, le Règlement général d'exemption par catégorie a été élargi. Ce Règlement recense les mesures qui n'ont pas besoin d'être signalées à la Commission *ex ante*. La grande majorité des aides, comme celles destinées aux PME ou affectées à la formation, à l'emploi, à l'innovation, ainsi qu'à la protection de l'environnement et aux régions, entrent dans le cadre du Règlement général.

De surcroît, des mesures de simplification ont été adoptées pour les aides qui doivent encore faire l'objet d'une notification. La première est la Procédure simplifiée, qui s'applique aux affaires qui ne présentent pas de difficultés et à celles auxquelles la Commission est rompue. L'objectif est d'en accélérer le traitement. La seconde mesure, à savoir le Code de bonnes pratiques, concerne les affaires qui sont trop complexes pour être traitées selon la Procédure simplifiée. L'objectif consiste à s'appuyer sur un partenariat entre la Commission et l'État membre en organisant des réunions préalablement à la notification. Ce train de mesures n'étant entré en vigueur que le 1^{er} septembre 2009, le représentant de l'Union européenne observe qu'il est encore impossible d'évaluer son efficacité. Néanmoins, un nombre croissant d'affaires ont été notifiées dans le cadre de la Procédure simplifiée et du Code de bonnes pratiques, ce qui semble avoir réduit sensiblement la durée des enquêtes dans les affaires complexes d'aides publiques. Autre succès qui mérite d'être mentionné : le pourcentage des aides couvertes par le Règlement général a grimpé de 34 % à 66 % au cours des deux dernières années.

2. Les éventuelles répercussions négatives des aides publiques et subventions

Le Président présente ensuite le deuxième thème de cette table ronde, les répercussions négatives que peuvent avoir les aides publiques et les subventions. Il insiste sur la qualité de la contribution de l'Égypte, qui a mis en évidence les conséquences néfastes, pour la concurrence, de l'octroi d'aides publiques et de subventions importantes insuffisamment réglementées. Le Président invite l'Égypte à formuler des commentaires sur la nature et l'ampleur des effets anticoncurrentiels produits par les subventions publiques dans son pays.

En premier lieu, la représentante de l'Égypte expose que son pays, à l'instar de bien d'autres, n'est doté d'aucune réglementation propre aux aides publiques et aux subventions. Qui plus est, la loi égyptienne sur la concurrence ne proscriit pas les aides publiques qui faussent la concurrence, ce qui explique pourquoi à ce jour, l'Autorité égyptienne de la concurrence n'a été saisie d'aucune affaire dans ce domaine. La représentante de l'Égypte explique cependant que l'Autorité de la concurrence est consciente qu'il importe de contrôler les aides publiques, d'autant que l'Égypte est censée mettre en place un système de contrôle de ces aides afin de respecter l'accord commercial conclu avec l'Union européenne. Outre les instruments usuels (transferts financiers directs, avantages fiscaux, cession d'intrants détenus par l'État à un prix inférieur au marché...), les aides publiques peuvent aussi prendre la forme d'une réglementation préférentielle. La représentante cite l'exemple de la loi égyptienne sur l'aviation civile, qui prévoit spécifiquement qu'« aucune compagnie aérienne ne peut se voir accorder de licence d'exploitation pour des lignes internes entrant en concurrence avec les itinéraires des compagnies égyptiennes en activité », même si on ne compte qu'une seule compagnie en activité dans le pays. Elle conclut en soulignant que l'Autorité égyptienne de la concurrence envisage d'introduire dans le droit de la concurrence des dispositions relatives aux aides publiques et aux subventions.

Le Président demande ensuite au représentant de la Pologne de commenter les engagements que les entreprises en difficulté ayant sollicité une aide ont dû prendre pour limiter les répercussions négatives des aides sur la concurrence. Le représentant de la Pologne explique que, pour évaluer l'efficacité des mesures compensatoires, il faut prendre en compte les conséquences de ces mesures pour l'entreprise qui en bénéficie et pour la concurrence sur le marché concerné. Les mesures compensatoires ont tendance à diminuer les capacités de production totales du bénéficiaire, ce qui bénéficie ensuite à ses concurrents. La Commission européenne impose en outre au bénéficiaire de remettre des rapports régulièrement (tous les six mois) pour pouvoir vérifier que la mesure compensatoire a été efficacement mise en œuvre. La majeure partie des entreprises acceptent d'appliquer une telle mesure par crainte qu'une décision de la Commission ne les oblige à rendre l'aide perçue. C'est un bon exemple d'efficacité de contrôle *ex post* des aides publiques.

Ensuite, le Président relève que la contribution du Taipei chinois décrit une intéressante affaire d'aides publiques accordées aux agriculteurs sous forme de subventions pour des achats de pesticides. Ces aides ont été soumises à une réglementation particulière car elles risquaient de brider la concurrence. Le représentant du Taipei chinois est invité à apporter des précisions sur cette affaire. Le représentant du Taipei chinois explique que, sur son territoire, la majorité des aides publiques ont été affectées à la promotion de la recherche et du développement dans des secteurs donnés, comme la haute technologie ou l'agriculture, ainsi qu'aux PME. Puis il commente l'affaire mentionnée par le Président. À la fin des années 90, le Conseil de l'agriculture a autorisé l'Association des agriculteurs à sélectionner des fournisseurs de pesticides par une procédure de marché public, puis à revendre ces pesticides aux agriculteurs à un prix inférieur. En 1998, les vendeurs privés de pesticides au détail ont déposé une plainte auprès de la Commission de contrôle des pratiques commerciales, estimant que ce dispositif était source de concurrence déloyale. La Commission a décidé d'interdire à l'Association des agriculteurs de vendre à ses membres des pesticides en-dessous du prix d'achat. Elle a également proscrit tout octroi de subventions aux agriculteurs qui ne soit pas justifié par une situation d'urgence.

Le Président constate que les effets dommageables peuvent également provenir des coûts élevés que peuvent occasionner, pour les autorités, des aides publiques et des subventions importantes. Il donne la parole au représentant de l'Inde dont la contribution traite précisément de l'impact des aides d'un montant élevé sur le budget de l'État.

Le représentant de l'Inde observe que, dans son pays, la Commission de la concurrence a vu le jour voilà 11 mois seulement et que les aides publiques et les subventions ne relèvent pas de ses attributions. Il explique également qu'en Inde les subventions sont accordées par les gouvernements des États ainsi que par l'administration centrale. Concernant les mesures prises par l'administration centrale, en 2002-2004, les subventions représentaient environ 4 % du PIB et approximativement 80 % du déficit budgétaire. Cela a fait l'objet d'un vif débat public. De nombreuses études et commissions ont souligné qu'une réforme du contrôle des aides publiques et des subventions s'imposait de toute urgence. Selon le représentant de l'Inde, l'administration centrale semble convenir de la nécessité de réformer les subventions.

Le Président demande à l'Inde quelle proportion du déficit budgétaire résulte, respectivement, des aides destinées aux producteurs et de celles accordées aux clients. Le représentant de l'Inde répond que la majeure partie des subventions a servi à soutenir le prix des produits alimentaires. Il existe, par exemple, un prix de soutien minimum pour le riz et le blé. Ce dispositif était conçu pour servir de régulateur en cas de pénurie de céréales. De même, un prix minimum a été fixé pour les engrais.

Le Président s'adresse ensuite à la Russie. Il note les modifications apportées en 2009 aux dispositions de la Loi fédérale russe de 2006 relative à la concurrence en ce qui concerne les aides publiques. Il demande au représentant de la Fédération de Russie d'expliquer les raisons de ces changements.

Le représentant de la Fédération de Russie explique que la loi de 1991 sur la concurrence interdisait tout octroi d'avantages concurrentiels à certaines entités économiques. Pour s'assurer de l'existence d'un système d'aides publiques transparent et qui favorise la concurrence, une disposition sur l'octroi des aides d'État ou municipales a été introduite dans la loi sur la concurrence en 2006. Cette loi définit différents objectifs de l'action publique qui peuvent donner lieu à des aides publiques, comme les objectifs sociaux ou culturels. En octobre 2009, l'expression « aides d'État et municipales » a été remplacée par « préférences d'État ou municipales ». Ces préférences d'État ou municipales se définissent comme l'octroi d'avantages à certaines entités économiques, notamment par des moyens non pécuniaires. Cette définition est plus large et davantage conforme aux normes du droit européen de la concurrence. Du point de vue procédural, l'octroi de préférences nécessite l'accord préalable du Service fédéral de lutte contre les monopoles de la Russie. De plus, ce service est habilité à porter une affaire devant les tribunaux afin d'obtenir le recouvrement des aides publiques illicites.

3. Justifications et limites éventuelles des aides publiques et des subventions

Le Président présente ensuite la troisième partie de la table ronde, qui porte sur les raisons justifiant les aides publiques en certaines circonstances. Il relève que dans son discours le Commissaire européen, M. Almunia, a signalé différentes affaires dans lesquelles les aides publiques et les subventions pouvaient se justifier. M. Frédéric Jenny demande alors au représentant de la Roumanie de décrire un dispositif d'aides publiques particulier, qui s'adresse aux PME dans le contexte de la crise financière.

Le représentant de la Roumanie déclare tout d'abord que la réglementation de l'UE est directement applicable à la Roumanie. Il insiste sur le fait qu'aucune banque roumaine n'a rencontré de difficultés financières dans le contexte de la crise financière. Par conséquent, les banques n'ont nullement eu besoin d'aides publiques spécifiques. Dans l'économie réelle, plusieurs dispositifs d'aides publiques ont été approuvés par la Commission européenne en vertu du Cadre temporaire de la Commission européenne. Parmi eux, deux dispositifs d'aides publiques ont été conçus pour aider les entreprises à surmonter la crise. Le premier est composé de garanties accordées par l'État aux PME et aux grandes entreprises afin de leur faciliter l'accès au crédit. Le second s'adresse spécifiquement aux PME et prend la forme de prêts bonifiés et d'une réduction de la prime à verser pour les garanties de prêts. Ces deux dispositifs sont autorisés jusqu'à la fin 2010. Seules les entreprises en difficultés financières au moment de la demande de garantie peuvent en bénéficier.

Le Président s'adresse à l'Argentine et fait remarquer que, selon la contribution argentine, la principale raison d'être des aides publiques et des subventions est de protéger l'emploi. La contribution rend notamment compte d'une affaire dans laquelle l'entreprise General Motors s'est vue octroyer des subventions pour mettre au point un modèle dont une part importante des composants devait être fabriquée dans le pays. Le Président se demande si cette aide a permis de promouvoir l'emploi et si elle a créé des problèmes de concurrence.

Puis le Président fait allusion à la contribution du Maroc. Il décrit les principaux arbitrages auxquels ont procédé les responsables de l'action publique et fait valoir que certaines aides publiques peuvent se justifier en dépit de leurs effets anticoncurrentiels. Les subventions agricoles, par exemple, ne semblent pas fondées d'un point de vue économique, mais elles revêtent une importante dimension sociale. Le Président demande alors au représentant du Maroc d'analyser cet arbitrage et d'évaluer la viabilité de cette stratégie à long terme.

Le représentant du Maroc déclare dans un premier temps que les principaux secteurs de l'économie marocaine sont l'agriculture et les PME. Ces deux secteurs appellent une intervention de l'État en raison de l'intensité de la concurrence internationale. Les aides publiques sont donc un instrument de cohésion sociale et de maintien de l'emploi. Elles prennent différentes formes et il y a lieu de noter que les subventions directes sont interdites au Maroc depuis l'an 2000. Le gouvernement marocain a donc pris plusieurs mesures liées à la crise, notamment à l'attention des entreprises exportatrices. Le représentant du Maroc souligne néanmoins que ces mesures ne sont pas discriminatoires, car chaque entreprise répondant à des critères objectifs prédéfinis peut bénéficier de ce dispositif. Il insiste sur l'importance du rôle consultatif joué par l'Autorité de la concurrence. De plus, il observe qu'en vertu de plusieurs accords commerciaux, le Maroc est dans l'obligation de proscrire les subventions qui faussent les échanges avec l'Union européenne.

4. Les mesures pouvant être appliquées pour améliorer l'évaluation et le contrôle des aides publiques et des subventions

Le Président présente le quatrième thème des débats de la table ronde. Comme l'examen du premier thème l'a montré, la situation est des plus hétérogènes en ce qui concerne le contrôle exercé, ou non, par les différents pays sur les aides publiques. On peut donc se demander comment contrôler les aides

publiques et les subventions. Certaines contributions ont présenté des éléments intéressants à cet égard, concernant leur traitement *ex ante* ou *ex post*. L'Ukraine, par exemple, a entrepris de mettre en place un système de suivi des aides publiques conforme à l'accord de libre-échange conclu avec l'Union européenne. Un groupe de travail a élaboré, avec l'assistance technique de l'UE, un concept préliminaire de système d'aides publiques devant servir de base à la future législation sur les aides publiques.

Le Président demande au représentant de l'Ukraine d'exposer les réalisations de ce groupe de travail et d'expliquer les étapes qui restent à franchir pour mettre en œuvre un système de suivi des aides publiques qui soit efficient. Le représentant de l'Ukraine souligne tout d'abord que, dans son pays, il existe un consensus sur la nécessité de mettre en place un système transparent de contrôle des aides publiques. Le 13 janvier 2010, une proposition de loi a été adoptée à cette fin par le Parlement. Élaborée par la Commission de lutte contre les monopoles avec le soutien du gouvernement, elle poursuit cinq grands objectifs : (i) la création d'un système de suivi des aides publiques ; (ii) l'inventaire de toutes les aides publiques accordées en Ukraine ; (iii) la rédaction d'orientations générales visant à aider les autorités publiques à faire la part entre les effets positifs et les effets négatifs d'une aide publique ; (iv) la présentation de rapports annuels sur les volumes et les formes des aides publiques et des subventions octroyées en Ukraine ; et (v) l'établissement d'un mécanisme de contrôle des aides publiques. Ces mesures devraient permettre de minimiser les effets néfastes des aides publiques et des subventions sur la concurrence. Le ministère des Finances sera responsable de la mise en œuvre des quatre premiers objectifs, la Commission de lutte contre les monopoles étant chargée d'évaluer l'impact des aides publiques sur la concurrence. Le représentant de l'Ukraine conclut son intervention en relevant que l'adoption de cette proposition de loi a contribué à la réalisation des engagements internationaux de son pays.

Le Président s'adresse ensuite au représentant de l'Ancienne République Yougoslave de Macédoine (ARYM). Il constate que la contribution de l'ARYM met l'accent sur les conditions draconiennes attachées à l'octroi d'une aide aux entreprises en difficulté. Ces conditions portent par exemple sur le remboursement des prêts spéciaux et sur la contribution du bénéficiaire à l'amélioration des conditions de marché. Il demande au représentant de l'ARYM de décrire avec plus de détail les modalités du contrôle *ex post*. En particulier, quelles sont les sanctions qui peuvent être prises à l'encontre des entreprises qui ne satisfont pas à ces conditions ? Certaines affaires récentes méritent-elles d'être mentionnées ?

Le représentant de l'ARYM explique que la Commission de protection de la concurrence est l'institution responsable du contrôle des aides publiques et que les règles applicables à ces aides depuis 2004 sont parfaitement conformes à la législation de l'Union européenne. Avant d'être mises en œuvre, les aides publiques doivent être portées à la connaissance de la Commission de protection de la concurrence et recevoir son aval. La Commission peut également imposer le remboursement d'une aide illicite. Jusqu'à présent, elle a ouvert trois procédures d'enquête officielles pour soupçons d'incompatibilité des aides publiques. Dans deux de ces affaires, l'aide accordée a été jugée illicite et a donc dû être remboursée. Ces deux affaires portaient sur des cessions de terrains détenus par des entreprises publiques à un prix inférieur au marché. Suite à la décision de recouvrer l'aide allouée, le bénéficiaire a dû s'acquitter, dans chacune des affaires, de l'intégralité du prix du terrain pratiqué sur le marché. Les deux décisions de la Commission ont donné lieu à une procédure d'appel devant le tribunal administratif et sont aujourd'hui dans l'attente d'un jugement.

Le Président s'adresse à l'Espagne et constate que les aides espagnoles doivent de fait être conformes aux règles de l'UE. Toutefois, les aides publiques *de minimis* ne relèvent pas de la compétence de la Commission européenne. Pour ce type d'aides, la loi espagnole sur la concurrence a doté l'Autorité de la concurrence d'un instrument de contrôle *ex post*. Le Président demande au représentant de l'Espagne de commenter les dispositions intéressantes. En particulier, à quelles lacunes du contrôle des aides publiques exercé par l'UE cette loi a-t-elle remédié ?

Le représentant de l'Espagne explique que la Loi espagnole sur la concurrence de 2007 permet à l'Autorité nationale de la concurrence d'analyser les dispositifs d'aides publiques à sa propre initiative ou sur requête des administrations. L'objectif est d'évaluer les effets potentiels de ces mécanismes sur la concurrence. Si les mesures publiques susceptibles de constituer une aide entrent dans les attributions de l'UE, l'Autorité de la concurrence recommande ensuite leur notification à la Commission. Deux affaires récentes importantes (concernant une proposition de soutien à l'industrie houillère et une loi relative au financement de la télévision publique) ont donc été signalées à la Commission. Dans les cas où le seuil *de minimis* n'est pas franchi, l'Autorité de la concurrence publie des rapports évaluant les avantages et les inconvénients de la mesure considérée. Ces rapports mettent en garde les autorités publiques contre les répercussions négatives des mesures envisagées et s'emploient à proposer des solutions de substitution qui créent moins de distorsions. De plus, l'Autorité de la concurrence a publié son premier rapport annuel en 2009. Ce rapport était essentiellement méthodologique et destiné à établir les critères économiques utilisés pour évaluer les aides publiques. Par ailleurs, le représentant de l'Espagne explique que l'Autorité de la concurrence est pourvue d'un instrument de contrôle *ex post*. Elle est habilitée à intenter des actions en justice lorsqu'une initiative administrative entrave le maintien d'une concurrence efficace sur les marchés. Cet instrument n'a pas encore été utilisé, mais il est apparu comme un puissant outil de dissuasion dans les relations qu'entretient l'Autorité de la concurrence avec les administrations.

Le Président s'adresse ensuite au représentant de la Croatie. Il fait observer que, selon la contribution écrite de ce pays, plusieurs enquêtes ont été ouvertes à la suite de plaintes faisant état d'un traitement discriminatoire par rapport à des concurrents bénéficiant d'aides publiques, en particulier dans le secteur du textile. Le Président invite le représentant de la Croatie à présenter brièvement une ou deux affaires de ce type.

Le représentant de la Croatie explique que l'Autorité croate de la concurrence est responsable de la mise en œuvre de la réglementation sur les aides publiques. Elle a déjà ouvert plusieurs enquêtes qui sont toutes en instance. En Croatie, la loi sur les aides publiques établit les conditions et règles générales applicables à l'autorisation, au suivi et au recouvrement des aides publiques. Ces aides se définissent comme des dépenses ou de moindres recettes de l'État effectives ou potentielles, accordées sous quelque forme que ce soit, qui faussent ou risquent de fausser la concurrence en favorisant certains bénéficiaires. Les aides publiques qui correspondent à cette définition sont proscrites par la loi. Néanmoins, les aides publiques peuvent servir à indemniser les victimes de dommages causés par des catastrophes naturelles exceptionnelles ; elles peuvent alors être déclarées compatibles avec la loi, mais elles sont soumises à l'autorisation préalable de l'organisme en charge de la concurrence. L'Autorité de la concurrence supervise la mise en œuvre des aides publiques autorisées de sa propre initiative ou sur requête de toute entité ayant un droit sur ces aides. Lorsque l'Autorité établit que des irrégularités ont été commises dans le suivi de la mise en œuvre des aides publiques, elle peut prendre une décision enjoignant l'organisme qui octroie l'aide ou le bénéficiaire de cette aide de remédier aux irrégularités en question dans les trois mois.

Le Président demande ensuite au Comité consultatif économique et industriel auprès de l'OCDE (BIAC) d'exposer son point de vue sur la méthode la plus indiquée pour réaliser une évaluation économique efficiente *ex ante* et *ex post* d'une aide publique. Le représentant du BIAC souligne que les entreprises sont favorables à une évaluation, au cas par cas, des répercussions des subventions sur la concurrence. Il explique que les autorités nationales ne peuvent à elles seules contrôler les aides publiques et les subventions car bon nombre d'entre elles mettent en jeu des questions internationales. Elles doivent néanmoins promouvoir autant que possible la transparence des aides publiques. Il relève également que la crise financière a éclairé les effets des subventions sous un jour nouveau. Elle a montré qu'elles peuvent aussi avoir des retombées positives, car elles peuvent contribuer à corriger les défaillances du marché. Selon le représentant du BIAC, les aides publiques ont permis de sauver de nombreux producteurs efficaces qui sans cela auraient fait faillite lorsque la source du crédit s'est tarie.

S'agissant de l'évaluation *ex ante* des aides publiques, le représentant du BIAC salue l'introduction par la Commission européenne de la Procédure simplifiée qui accélère le traitement de nombreuses affaires. Pour le représentant du BIAC, la différence entre l'UE et l'OMC est que le principal objectif de l'UE aura été l'intérêt économique commun de la communauté européenne. À l'inverse, l'OMC ne s'est pas intéressée au bien commun, mais davantage à la question de savoir si un avantage indu a été octroyé à un concurrent donné. De plus, les règles de l'OMC prévoient uniquement un contrôle *ex post*, ce qui s'avère efficient uniquement si l'on applique des mesures compensatoires sur le marché où le dommage a été occasionné. Quoi qu'il en soit, ainsi que le précise le représentant du BIAC, de telles mesures nuisent souvent aux consommateurs car elles entraînent des hausses de prix.

Le Président s'adresse ensuite au Pérou. Le représentant du Pérou indique que son pays ne s'est pas encore doté d'un dispositif complet pour analyser les aides publiques. S'agissant des interventions menées par les pouvoirs publics par le biais des entreprises publiques, il existe des contrôles *ex ante* et *ex post*. *Ex post*, les entreprises peuvent déposer plainte auprès de l'Autorité de la concurrence si elles estiment que le comportement d'une entreprise publique leur porte préjudice. *Ex ante*, les pouvoirs publics sont soumis à un contrôle en trois étapes lorsqu'ils créent de nouvelles entreprises publiques : (i) la participation de l'État à l'activité de l'entreprise doit être autorisée par une loi spécifique et elle doit alors être approuvée par le Congrès ; (ii) l'intervention de l'État ne doit ni empêcher l'entrée de nouveaux concurrents sur le marché ni en exclure les concurrents en place ; et (iii) l'État n'est autorisé à participer aux activités d'une entreprise que lorsque cela sert l'intérêt public.

Enfin, le Président demande au trois experts qui participent à la table ronde de présenter leurs conclusions.

M. Amadou Dieng insiste tout d'abord sur la différence existant entre les aides isolées et les dispositifs généraux. Selon lui, ces dispositifs généraux se justifient d'un point de vue économique dans la majorité des cas. Le problème important est celui du suivi de la mise en œuvre de l'aide. Ce suivi doit s'effectuer au cas par cas. La plupart des distorsions, en effet, ne viennent pas de l'aide elle-même mais de sa mise en œuvre. Il importe ainsi de confier aux autorités de la concurrence le contrôle de la mise en œuvre de l'aide. Le contrôle *ex post* est donc tout autant nécessaire que le contrôle *ex ante*.

M. David Spector analyse la question du critère d'établissement de la preuve dans les affaires d'aides publiques. Il établit une comparaison entre les affaires de fusions et celles qui traitent des aides publiques. Dans les deux cas, les autorités de la concurrence évaluent les avantages et les inconvénients : les efficacités possibles d'une part et les effets anticoncurrentiels possibles de l'autre. Ce faisant, les autorités doivent, selon M. Spector, partir d'un point de vue *a priori* légèrement négatif : en principe, les aides devraient être proscrites à moins de remplir certaines conditions. La raison en est que certains de leurs effets dommageables sont très indirects et ne se prêtent que difficilement à une évaluation. La recherche d'une rente et les incitations négatives résultant d'une faible contrainte budgétaire illustrent les effets indirects néfastes des aides publiques qui ne se limitent pas au secteur où l'aide est accordée. De même, le dommage occasionné par le coût d'opportunité élevé des fonds publics est aussi un effet indirect des aides publiques et, en règle générale, il n'est pas pris en compte dans l'évaluation des avantages et des inconvénients d'une aide. Selon M. Spector, toutes ces raisons conduisent à adopter une présomption négative et appellent un critère d'établissement de la preuve relativement strict avant d'estimer qu'une aide est justifiée.

M. Michael Thöne formule trois commentaires au sujet des débats. Premièrement, il convient que le contrôle des subventions doit être exercé au cas par cas. Il regrette toutefois que les autorités de la concurrence se concentrent par trop sur des affaires spécifiques sans livrer d'évaluations générales de la politique menée par les pouvoirs publics en matière d'aides publiques. De telles évaluations pourraient être particulièrement utiles pour améliorer la transparence et la dissuasion. Deuxièmement, M. Thöne

encourage les autorités de la concurrence à considérer les aides publiques dans une perspective plus large. Elles doivent non seulement faire la part des effets positifs et des effets négatifs d'une mesure donnée, mais aussi déterminer si la décision correspondante était justifiée ou non de prime abord. Enfin, il déclare, au sujet de l'intervention du représentant de la Pologne, qu'il juge très intéressante l'idée de contraindre les entreprises bénéficiant d'une aide publique à évaluer l'impact négatif que cette aide pourrait avoir sur leurs concurrents.

Le Président demande alors au BIAC de commenter les affaires d'aides accordées aux entreprises publiques. Le représentant du BIAC déclare que les entreprises publiques sont pour lui un sujet de préoccupation, en particulier leur capacité d'éviction et de discrimination à l'encontre de leurs concurrents en amont et en aval. Il reconnaît cependant qu'elles ne sont pas nocives en elles-mêmes et il affirme que, pour évaluer les effets d'une aide, il faut tenir compte davantage des dommages occasionnés à la concurrence que de ceux subis par les concurrents.

Le Président de la session, M. Mestassi, demande à M. Frédéric Jenny de formuler ses conclusions. M. Jenny met en relief quelques points qui ont émergé du débat. Premièrement, il constate que, sur la question des aides publiques, les pays membres et non membres de l'OCDE, pays développés ou en développement ne sont pas divisés. Comme l'a montré M. Spector, cette question revêt une grande importance dans l'ensemble des pays. Deuxièmement, M. Jenny constate qu'il n'existe pas de préjugé systématique à l'encontre des aides publiques. Ainsi que l'a expliqué le Commissaire Almunia, on a de bonnes raisons de penser que les aides publiques se justifient dans certaines circonstances, notamment pour corriger les défaillances du marché, ou pour promouvoir des investissements qui génèrent des externalités positives. Les économistes sont parfaitement au fait de ces objectifs. D'autres raisons sont plus politiques : elles touchent à la promotion d'objectifs sociaux, qui peuvent être justifiés même s'ils ne sont pas totalement conformes à l'analyse économique classique, qui tend à privilégier le recours aux transferts directs sans effets de distorsion. Le Maroc, par exemple, a expliqué très clairement que certaines visées sociales doivent être appréciées au regard des considérations d'efficacité : les pouvoirs publics dans leur ensemble ne sont pas uniquement attentifs à la concurrence, mais aussi à des enjeux plus vastes. Troisièmement, M. Frédéric Jenny constate que les interventions des représentants et les contributions des pays ont montré que la quasi-totalité des secteurs de l'économie bénéficient d'aides publiques. Cela étant, l'idée que les aides publiques ont tendance à avantager certains concurrents a fait l'unanimité. Cela concerne la concurrence entre les entreprises, mais aussi entre les nations. Une grande partie des aides publiques peuvent avoir des répercussions sur les échanges internationaux.

Selon M. Jenny, tout cela montre qu'il est impératif de mettre en place un système de contrôle des aides publiques qui soit efficace. Le contrôle des aides publiques s'exerce au niveau national, régional et multilatéral. Il doit se caractériser par les éléments suivants : transparence, non-discrimination et veiller à ce que les aides ne faussent pas la concurrence. Cela passe par une évaluation des répercussions des aides au cas par cas. Dans chaque circonstance, il convient de se demander, de façon approfondie, si l'aide en jeu est le moyen le plus indiqué pour atteindre l'objectif visé. Les débats font également ressortir que les autorités de la concurrence peuvent intervenir de bien des manières. Celles qui ne sont pas strictement chargées de contrôler les aides publiques peuvent tout de même influencer sur les décisions des pouvoirs publics à l'aide de notes d'orientation, de différentes activités de sensibilisation et d'interventions auprès des tribunaux.